

L&S ENGINEERS

2024 WORKSHOP

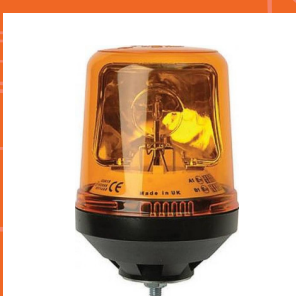

L&S Engineers Ltd
Coppice Side, West Coppice Road
Brownhills, Walsall, WS8 7EX

Tel. 01543 378189
sales@lengineers.co.uk
www.lengineers.co.uk

Contents



	Towing & Trailer	A-1		Gas Equipment	F-1
	Vehicle Electrics	A-29		Tar Equipment	F-8
	Flashing Beacons	A-38		Spanners & Socketry	G-1
	Vehicle Signs	A-44		Threading Taps and Drilling	G-10
	Water Pump Spares	B-1		Hand Tools	G-21
	Hose & Couplings	B-10		Fasteners & Fixings	H-1
	Drainage and Rodding Equipment	B-25		Assorted Boxes	H-16
	Pressure Washer Spares	B-31		Hardware	I-1
	Lifting Equipment	C-1		Packaging	I-17
	Load Securing	C-12		Abrasives	I-35
	Fuelling & Greasing	D-1		Welding	I-48
	Spill Handling	D-7		Chemicals & Sprays	I-57
	Electrical Cable & Connectors	E-1		PPE & Workwear	J-1
	Lighting	E-7		Health & Safety	J-14

2024 Pricing

At L&S we do our very best to keep our prices stable each year, by working closely with our suppliers and absorbing costs where possible.

Due to uncertainty of both supply and input costs we reserve the right to increase prices without prior notice. Please check our website for up to date pricing at www.lsengineers.co.uk



L&S Engineers was formed in 1971 by Wyn Lees and Alan Shaw and operated from a small garage rented from the Coal Board. Originally a small engineering firm, making custom fabrications, water pump strainers and starting handles, the business supplied local customers and sub contracted to larger companies based in the West Midlands.

The business outgrew the original premises and relocated to Bridgetown in the mid 70's, where it continued to undertake a variety of fabrication and machinery work for the construction, plant hire, quarrying and engineering industries. Around this time, the company started to supply a small number of engine and small plant spares to its existing customers.



The spares side continued to grow and in the 80's, the business started a van delivery service which supplied spare parts and consumables to businesses all around the UK. The vans would be loaded to the limit and driven all over the country where customers would queue eagerly sometimes filling wheelbarrows with cheap parts from the North!

In 1986 we moved to West Coppice Road in Brownhills, just outside Walsall. The engineering side of the business was sold off in 1992 to concentrate on the growing spares business. Then in December 2015, we moved across the road into a brand new warehouse and office building.



Trailer Boards

4FT 6" TRAILER BOARD

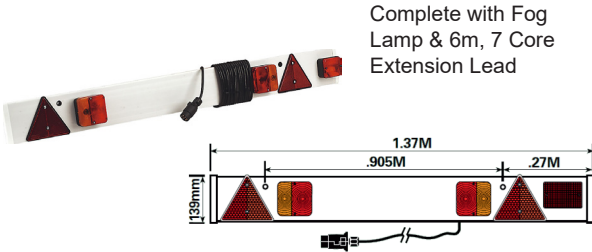

Complete with Fog Lamp & 6m, 7 Core Extension Lead

Part No.	Price
200 101	£30.58

3FT TRAILER BOARD

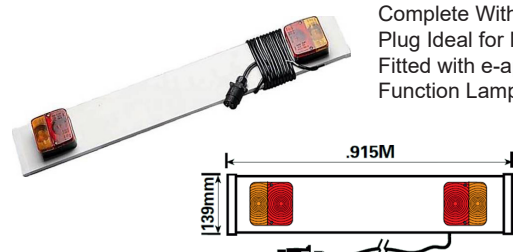

Complete With 4m Lead and Plug Ideal for Narrow Trailers, Fitted with e-approved Square Function Lamps

Part No.	Price
200 138	£18.25

4FT TRAILER BOARD

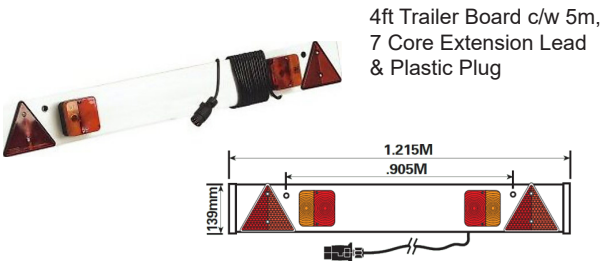

4ft Trailer Board c/w 5m, 7 Core Extension Lead & Plastic Plug

Part No.	Price
200 100	£21.00

TRAILER BOARD MODULE

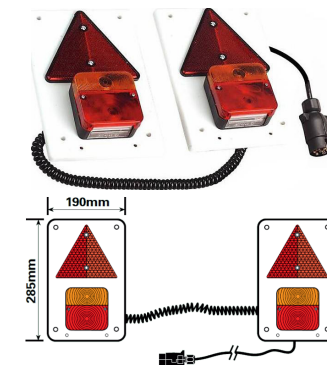

12v Trailer Board Lighting Module Lighting modules, consist of 2 durable plastic modules each fitted with combination lamp and triangle connected by an extendible curly cable, wired with 7 core trailer cable.

Part No.	Price
200 129	NLA

LED TRAILER BOARDS



LED Trailer Boards in Various Sizes

Complete with 7 Core Extension Lead

Part No.	Length	Cable	Extra Features	Price
015 049	3'	4m	-	£29.95
207 253	4'	5m	c/w 2 triangles	£35.45
015 047	4' 6"	6m	c/w 2 triangles & fog light	£68.95

MAGNETIC LIGHTING MODULE



6' Unit With 6m Cable & Number Plate Fixing Bracket, 2 x four function lamps, triangles and fitted with powerful magnets for quick and easy attachment

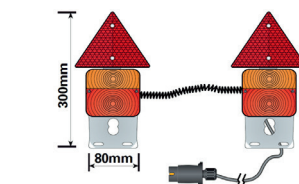

Part No.	Price
200 137	£30.14

MAGNETIC LED LIGHT SET



12v Magnetic LED Trailer Lights - 100mm x 100mm
Cable length between modules 2.5 metres
Cable length with plug 6 metres

Part No.	Price
015 046	£40.42

HEAVY DUTY RUBBER BUFFER



Ideal for Vehicles & Loading Bays. Reinforced Holes
Length: 250mm
Height: 90mm
Width: 80mm

Part No.	Price
999 925	£7.31

Vehicle Lighting

				
12v Lamp - 98x102mm Stop, Tail, Indicator & Number Plate	Replacement Lens for 200 103	Round Rear Offside 140x80mm Bulb Holder	Round Rear Nearside 140x80mm Bulb Holder	12v LED Lamp 100x100mm Stop, Tail & Indicator
200 103 £2.95	200 105 £1.95	720 100 £19.29	720 105 £20.96	802 176 £16.90
				
12v Rear Combination Lamp Fits Iveco Daily 300x105mm	12v Budget LED Lamp 106x98mm Stop, Tail, Indicator & Number Plate	LED Marker Lamp E Approved, IP67 Rated Suits 12 & 24v Systems	LED Marker Lamp E Approved, IP67 Rated Suits 12 & 24v Systems	LED Marker Lamp E Approved, IP67 Rated Suits 12 & 24v Systems
125 1398 Right £30.33 007 601 Left £30.62	200 119 £8.90	802 173 £12.32	802 172 £10.20	802 171 £8.70
				
10-30v LED Red Marker Lamp 70x38x33mm	10-30v LED Clear Marker Lamp 70x38x33mm	10-30v LED Amber Marker Lamp 70x38x33mm	12v Rear Fog lamp 89x77x55mm	12v Rear Fog Lamp c/w Mounting Bracket 140x70x65mm
207 010 £7.95	207 020 £9.45	207 015 £8.15	200 104 £3.95	200 130 £5.95
				
12-30v LED Number Plate Lamp 118x50x53mm	12v Number Plate Lamp 70x60x40mm	Side Marker Lamp Red/Clear 94x83x81mm	Stop/Tail Bulb	Indicator Bulb
207 227 £6.52	200 975 £5.29	800 153 £9.50	LLB380 12v £0.46 200 108 24v £1.05	LLB382 12v £0.46 200 109 24v £0.65

Vehicle Lighting

				
12v Combination Lamp Unit 350x130x83mm	12/24v LED 6 Function Horizontal Combination Lamp	Universal Rear Lens Only Fits Ford/Leyland Vans	12v 6 Function Lamp 220x140x60mm	12/24v LED 6 Function Vertical Combi Lamp (sold separately)
007 100 Lamp Unit £60.47	007 603 Right £36.45	063 950 £34.88	802 179 Right £11.50	802 180 Near/s (LH) £34.92
007 198 Lens Only £21.70	007 602 Left £37.01		802 178 Left £11.50	802 181 Offside (RH) £34.92
				
12v Combination Lamp Unit Fits Terex Dumpers 200x92mm	Neon LED Rear Combination Lamp 10-30v 236x104mm	Rectangular Reflector Size: 95x43mm Amber	Red Rear Reflector 60mm Diam	Clear Front Reflector 60mm Diam
029 550 £18.50	883 001 £60.71	705 183 £1.53	203 130 £0.75	203 131 £0.75
				
Amber Side Reflector 60mm Diam	Red Triangle Reflector 140mm	Red Rear Reflector 75mm Wide	Clear Front Reflector 75mm Wide	Amber Side Reflector 75mm Wide
203 132 £0.75	200 133 £0.75	200 134 £0.85	200 136 £0.85	200 135 £0.74
				
12v Interior Fluorescent Lamp 376x86x29mm	12v 30 LED Interior Lamp 550x80mm	Lamp Guard c/w Fixings 110x155x75mm	Vertical LED Marker Lamp Bracket Kit 171x64mm	Horizontal LED Marker Lamp Bracket Kit
999 880 £30.89	829 510 NLA	200 141 £9.27	802 175 £1.20	125 1580 £2.52

Vehicle Lighting

				
18W LED Work Lamp 10-30v / IP67 / 110mm	18W LED Work Lamp 10-32v / IP67 / 76mm	24W LED Work Lamp 10-30v / IP67 / 114mm	30W LED Work Lamp 10-32v / IP68 / 114mm	42W LED Work Lamp 10-30v / IP67 / 110mm
042 208 £16.14	042 203 £13.84	042 824 £14.50	042 204 £42.07	042 200 £37.03
				
48W LED Work Lamp 10-32v / IP68 / 133mm	10W LED Work Lamp 9-60v / IP67 / 98mm	20W LED Work Lamp 10-30v / IP67 / 110mm	18W LED Work Lamp 12/24v / IP67 / 135mm	20W LED Work Lamp 10-30v / IP67 / 120mm
042 206 £42.87	042 207 £16.60	042 209 £14.50	042 813 £14.73	042 205 £24.50
				
24W LED Magnetic Beacon Bar 12-24v	LED Marker Light Set 10-30V	Rectangular Work Lamp Polycarbonate Lens, 55W	Round Work Lamp Polycarbonate Lens, 55W	12v High Power Work Lamp Swivel & Tilt Bracket
042 202 £46.30	042 287 £22.50	200 167 24v £22.35	200 164 12v £18.25 200 165 24v £19.17	200 989 £12.81
				
12v Magnetic Work Lamp 3m Coiled Cable & Plug	Blade Fuse Holder (Each)	Illuminated Rocker Switch 12V/20A	Twin Core Cable 8.75amp (Black) 10 Metres	Twin Core Cable 8.75amp (Black) 30 Metres
053 856 £56.90	BFH £2.07	295 203 £1.30	124 0320 £7.21	124 0319 £21.77

Plugs, Sockets & Leads

				
Caravan & Trailer Socket Plastic Body 7-Pin, 12v (12N Type)	Caravan & Trailer Socket Metal Body 7-Pin, 12v (12N Type)	Electrical Coil Socket Metal Body 7-Pin, 24v (24N Type)	Euro Socket Plastic Body 13-Pin, 12v	Trailing Socket Plastic Body 7-Pin, 12v (12N Type)
200 111 £1.70	200 113 £3.30	750 075 £14.15	953 603 £7.12	200 114 £2.40
				
Caravan & Trailer Plug Plastic Body 7-Pin, 12v (12N Type)	Caravan & Trailer Plug Metal Body 7-Pin, 12v (12N Type)	Electrical Coil Plug Metal Body 7-Pin, 24v (24N Type)	Euro Plug Plastic Body 13-Pin, 12v	7-Pin Socket Cover PVC, Black
200 110 £1.55	200 112 £2.80	750 070 £12.65	953 602 £6.90	TR242 £1.35
				
12v Conversion Adaptor 7-Pin (12N) Vehicle to 13-Pin Trailer	12v Conversion Adaptor 13-Pin Vehicle to 7-Pin (12N) Trailer	7-Pin Plug Cover PVC, Black	Rubber Socket Seal For Sealing Behind 7-Pin Sockets	Single Mounting Bracket for 7-Pin Socket
953 600 £6.50	953 601 £6.50	TR137 £1.02	TR99 £0.55	TR88 £2.22
				
Double Mounting Bracket for 2 7-Pin Sockets	Fixing Kit for Fixing 7-Pin Sockets	8-way Junction Box Mounted in a Waterproof Rubber Base	7-Pin Socket & Plug Tester Requires 1 x 9v Battery	13-Pin Socket Tester c/w 3.5m Cable
TR92 £2.90	TR246 £0.95	705 167 £35.07	998 001 £16.50	998 002 £47.77

Number Plate Accessories

				
7 Core Trailer Cable 12v Applications 10 Metre Length	8 Core Trailer Cable 12v Applications 10 Metre Length	12 Core Trailer Cable 12v Applications 5 Metre Length	7-Pin Extension Lead Male / Female 6 Metre Length	7-Pin Extension Lead Male / Male 3 Metre Length
124 0165 £16.50	124 0168 £20.28	124 0171 £30.21	200 116 £14.95	200 117 £9.90
				
7 Pin Curly Extension Lead - Male/Male 4m Max Length	10-30V LED Number Plate Lamp	Self Adhesive Square Number Plate - Yellow 280mm x 210mm Not suitable for Highway Use	Magnetic Square Number Plate - Yellow 280mm x 210mm Not suitable for Highway Use	Magnetic Oblong Number Plate - Yellow 515x115mm Not suitable for Highway Use
803 750 £27.50	207 227 £6.52	200 597 £18.98	200 599 £19.55	200 970 £19.55
				ABCDEFGHIJ KLMNOPQRS TUVWXYZ 0123456789
Number Plate Holder Ideal for Solid Number Plates 530x125mm	Stainless Number Plate Holder - 2 per plate Plate Height 110-120mm	Self Adhesive Digit Single Pack P/N: DIGIT (Character)	Self Adhesive Digits 10 Pack P/N: DIGIT (Character)10	Self Adhesive Digits Full Character Set: A-Z 0-9
TR278 £6.95	800 0116 £4.62	DIGIT ... (each) £0.25	DIGIT ...10 £2.25	DIGIT KIT £8.10
				
Self Adhesive Double Sided Number Plate Pads 75x25mm Pack of 50	Assorted Box of Number Plate Fixings 240 Sets	Flip Top Screws 8 x 3/4" 100 Sets	Cap, Dome & Screws 8 x 3/4" 100 Sets	Nylon Nuts & Screws 1" Long, Slotted 100 Sets
705 099 £3.93	105 110 £15.06	903 1726 Yellow £4.80 903 1725 White £4.80	903 1711 Yellow £7.33 903 1710 White £7.38	903 1691 Yellow £5.74 903 1690 White £5.74

Towing Accessories

				
50mm Forged Tow Ball 90mm Hole Centres	50mm High Reach D Value - 17.2KN S Value - 350Kg Suits ALKO Couplings	50mm Ball & Pin Hitch 25mm Diam Pin D Value - 20KN S Value - 350Kg	25mm x 133mm Replacement Pin for 207 082	PVC Cover suitable for most 50mm Tow Balls
200 131 £9.95	207 083 £12.10	207 082 £31.52	207 084 £9.75	TR39 £2.24
				
50mm PVC Tow Ball Cover with Reflector to suit ALKO Tow Balls	1.1/2" Spacer Block 90mm Hole Centres for 50mm Tow Ball	Tow Ball Bumper Protector 90mm Bolt Hole Fixings	Secondary Coupling/Safety Cable for Unbraked Trailers	Vehicle Fixing Plate 97 X 30mm
500 500 £3.18	TR234 £9.24	802 001 £3.27	200 635 £6.90	200 4985 £1.42
				
Towball Cover Black Plastic/Aluminium fits 50mm Ball	50mm Tow Ball Lock Fixes into 50mm Coupling Head to Prevent Theft	Trailer Hitch Lock - 50mm Blocks Coupling to Prevent Theft	Heavy Duty Towing Eye Lock Suitable for 40mm & 50mm Towing Eyes	ABUS 82/70 Shutter Padlock for Heavy Duty Towing Eye
TR244 Black Plastic £0.75 TR239 Aluminium £5.53	200 132 £13.50	953 100 £18.35	200 326 £12.65	908 270 £27.07



Heavy Duty Eye Lock

The SAS Eye Lock is an extremely tough, Heavy Duty Eyelock constructed of up to 12mm thick steel that completely covers the Towing Eye Hitch, making them virtually indestructible, and is a popular product for utility contractors to secure their plant trailers.



Part No.	Description	Price
SAS2731721	Eye Lock 30/40mm	£80.70
SAS2751721	Eye Lock 50mm	£98.90

Towing Jaws

E40TC 3.5 TON COMBINATION TOWING BRACKET



2 Bolt Fixing Towing Jaw complete with 50mm Ball
Pin Diameter: 25mm
D Value (Horizontal Force): 17kN.
S Value (Static Vertical Load): 200kg
Bolt Hole Centres 90mm (M16)
EC94/20 Approval e11*94/20*000098

Part No.	Description	Price
800 160	Towing Bracket with Safety Lock	£117.00
KIT 172	Replacement Pin	£66.02
800 158	V35B Nut & Bolt Kit	£14.90

HEAVY DUTY 3 TON 50MM BALL HITCH WITH PIN



Max static load - Ball: 3300lbs/1500kg
Max static load - Pin: 8800lbs/4000kg
Hole Centres 89mm (M16)
Jaw Height: 50mm
Total weight of the vehicle must not exceed 3 tons

Part No.	Description	Price
S4057	Towing Bracket with Safety Pin	£32.00
S4061	Replacement Pin	£7.95
800 158	V35B Nut & Bolt Kit	£14.90

DIXON-BATE 3.5 TON COMBINATION TOWING BRACKET



2 Bolt fixing Heavy Duty Universal Towing Jaw complete with 25mm Pin & 50mm Ball
D Value: 17.5kn
S Value: 250kg



Part No.	Description	Price
201658	Towing Bracket with Safety Pin	£85.30
800 194	Replacement Pin & Chain	£19.25
800 158	V35B Nut & Bolt Kit	£14.90

DIXON-BATE 5 TON COMBINATION TOWING BRACKET



4 Bolt fixing Heavy Duty Universal Towing Jaw complete with 32mm Pin & 50mm Ball
D Value: 20.66kn
S Value: 250kg



Part No.	Description	Price
201691	Towing Bracket with Safety Pin	£161.30
800 1850	Replacement Pin & Wire	£68.91
V50B	V50B Nut & Bolt Kit	£7.23

Towing Jaws & Pins

ADJUSTABLE HEIGHT BRACKET AND BOLT KIT

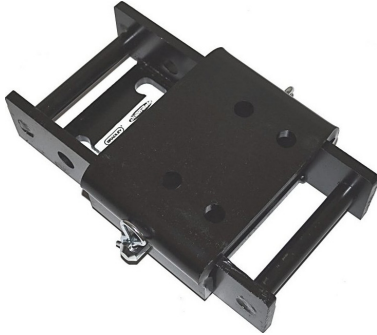

The Dixon-Bate Towing Adjustable Height Coupling Provides Adjustment in 50mm Increments. The Slider has Four Pre Drilled Holes to Accept Towing Couplings with Either 2 Hole Fixing (BS AU11A) or 4 Hole Fixing (BS AU24). The Slider is Secured in Place by A 19mm Dia Steel Pin and R Clip, No Need for Tools at all.



Part No.	Description	Price
202 092	100mm Adjustable Height Bracket	£145.60
202 091	150mm Adjustable Height Bracket	£162.70
202 090	200mm Adjustable Height Bracket	£191.00

REPLACEMENT SLIDER



Dixon Bate Replacement Slider for Height Adjustable Bracket.



SLIDER PIN



Slider Pin for Adjustable Height Bracket



Part No.	Price
66790	£46.18

Part No.	Price
66702	£12.60

TOW PINS

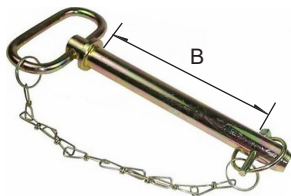

Complete with Lynch Pin & Chain For Agricultural/Site Use EN-8 Carbon Steel

50MM BALL HITCH TOW PINS

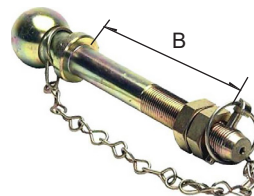

Must Be Used With Locknuts Fully Tightened and Lynch Pin (Supplied) Zinc Passivated

Part No.	Pin Ø	Working Length (B)	Price
TP58	5/8"	3 7/8"	£6.50
TP34	3/4"	6"	£3.10
TP78	7/8"	6"	£3.40
TP1	1"	6"	£4.90
TP114	1.1/4"	7"	£7.80

Part No.	Pin Ø	Working Length (B)	Towing Capacity	Price
TP3210	7/8"	6 1/4"	1250kg	£16.00
TP3211	1"	6 1/4"	2000kg	£18.50

Trailer Breakaway Cable Length: 42"	Breakaway Cable Suitable for Ifor Williams Trailers	Hi-Vis Breakaway Cable Length: 1m	Trailer Breakaway Cable Length: 1m
500 129	500 135	500 138	KIT 130
£1.95	£3.95	£4.80	£5.60

Couplings

KNOTT-AVONRIDE CAST DELTA COUPLINGS



Knott-Avonride Cast Delta Couplings
Supplied with either a 50mm Cast Locking Head or 40mm Cast Eye

(other couplings & heads available - please contact us)



KFG27			KFG30			KFG35		
Capacity: 1400-2700kg Nose Load: 150kg			Capacity: 1600-3000kg Nose Load: 150kg			Capacity: 2700-3500kg Nose Load: 150kg		
Part No.	Head/Eye	Price	Part No.	Head/Eye	Price	Part No.	Head/Eye	Price
KCB27AOD	c/w 50mm Head	£283.20	KCB30AOD	c/w 50mm Head	£278.50	KCB35AOD	c/w 50mm Head	£329.30
KCB274OD	c/w 40mm Eye	£252.90	KCB304OD	c/w 40mm Eye	£271.90	KCB354OD	c/w 40mm Eye	£315.20

KNOTT-AVONRIDE SQUARE TUBE COUPLINGS

Square Tube Couplings for 80mm Box Section Trailers
Supplied with either a 50mm Cast Locking Head or 40mm Cast Eye

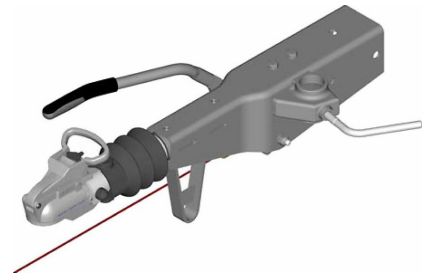

KRV13			KRV20		
Capacity: 750-1300kg Nose Load: 75kg			Capacity: 1100-2000kg Nose Load: 75kg		
Part No.	Head/Eye	Price	Part No.	Head/Eye	Price
KSB13AO8D	c/w 50mm Head	£274.80	KSB20AO8D	c/w 50mm Head	£293.20
KSB134O8D	c/w 40mm Eye	£269.20	KSB204O8D	c/w 40mm Eye	£263.10



KNOTT HYDRAULIC DAMPERS



Hydraulic Damper Kits to suit
Knott-Avonride Couplings



Part No.	Description	Price
800 0040	Fits KRV7.5, KF7.5	£57.78
800 0041	Fits KRV13, KFG13, KF13	£55.10
800 0042	Fits KRV20, KFG20, KF17, KF20, KRV17	£65.47
800 0043	Fits KFG27, KF27 (Old Type 12mm Ø)	£75.93
800 0044	Fits KFG27, KF27 (14mm Ø)	£81.47
800 0045	Fits KFG30 KRV30 (Old Type 12mm Ø)	£80.50
800 0046	Fits KFG30 KRV30 (14mm Ø)	£80.50
800 0047	Fits KFG35, KFGL35	£88.60

BRADLEY HYDRAULIC DAMPER

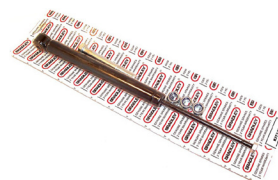

Hydraulic Damper Kits to suit
Bradley Hydratow, European
& Square Type Couplings

Part No.	Description	Price
KIT 3220	Fits HU3H, HU8H, EH17 & S18	£58.50
KIT 260	Fits HU3HE, EH27 & S26	£65.00
KIT 255	Fits HU10, HU12, HU14 & EH35	£65.00

Weld on Towing Eye L:302mm x W:90mm Eye Dia: 50mm	Unbraked Safety Cable	Security Ball	'R' Clip & Chain	1400kg Unbraked Pressed Head Suits 50mm Box	Plug Holder
200 145 £42.40	800 0143 £10.87	800 0117 £5.37	800 0166 £15.53	800 0108 £21.08	800 0119 £3.65
Equaliser Bar	Half Shell (EA)	Grease Gun Kit	Service Kit	Half Shell (2pcs)	Eyelet Kit (2pcs)
800 0120 £11.80	761 538 £2.60	800 0124 £17.88	800 0118 NLA	800 0153 £3.77	800 0156 £12.93

Couplings

KNOTT 50MM CAST HEAD



Unbraked 50mm Ball Hitch Coupling.
- 75mm Hole Centres
- Lockable c/w 2 keys
- 50mm square section
- Max Capacity: 2600kg

KNOTT

Part No.	Price
800 0178	£44.55

PRESSED STEEL COUPLING



50mm Unbraked Pressed Steel Towing Coupling suitable for 50mm square drawbars

- For trailers up to 750kg

Part No.	Price
800 189	£16.58

50MM CAST LOCKING HEADS



50mm Ball Heads to suit KFG27, KFG30, KFG35, KRV13 & KRV20 Couplings

800 0000 is supplied with reducer to fit 45mm Ø drawtubes

KNOTT

Part No.	Description	Price
800 0000	KFG27, KRV13, KRV20 (Also Fits: KFG13, KFG20, KF7,5, KF13, KF17, KF20, KF27, KRV7,5, KRV17) (45/50mm Ø with M12/M12 Fittings)	£83.10
800 0001	KFG30 (also Fits KRV30) (50mm Ø with M12/M14 fittings)	£105.90
800 0002	KFG27-30 (also Fits KRV30) (50mm Ø with M14/M14 fittings)	£86.70
800 0003	KFG35 (60mm Ø with M14/M14 fittings)	£90.00
800 0009	Replacement Lock Kit c/w 2 keys	£16.70

40MM CAST EYES



40mm Cast Eyes to suit KFG27, KFG30, KFG35, KRV13 & KRV20 Couplings

KNOTT

Part No.	Description	Price
800 0010	KRV13, KRV20 (Also Fits: KFG13, KFG20, KF7,5, KF13, KF17, KF20, KRV7,5, KRV17) (45mm Ø with M12/M12 Fittings)	£81.00
800 0011	KFG27 (Also Fits: KF27) (50mm Ø with M12/M12 Fittings)	£81.00
800 0012	KFG27-30 (Also Fits: KRV30, KF27) (50mm Ø with M14/M14 Fittings)	£81.00
800 0013	KFG30 (Also Fits: KRV30) (50mm Ø with M12/M14 Fittings)	£81.00
800 0014	KFG35 (60mm Ø with M14/M14 fittings)	£81.00

50MM CAST EYES



50mm Cast Eyes to suit KFG27, KFG30, KFG35, KRV13 & KRV20 Couplings

KNOTT

Part No.	Description	Price
800 0111	KRV13, KRV20 (Also Fits: KFG13, KFG20, KF7,5, KF13, KF17, KF20, KRV7,5, KRV17) (45mm Ø with M12/M12 Fittings)	£92.50
800 0114	KFG27 (Also Fits: KF27) (50mm Ø with M12/M12 Fittings)	£92.50
800 0115	KFG27-30 (Also Fits: KRV30, KF27) (50mm Ø with M14/M14 Fittings)	£92.50
800 0112	KFG30 (Also Fits: KRV30) (50mm Ø with M12/M14 Fittings)	£92.50
800 0113	KFG35 (60mm Ø with M14/M14 fittings)	£92.50

STOP RINGS (CURRENT)



Knott-Avonride Stop Rings for Current Models

KNOTT

Part No.	Description	Price
800 0030	KRV13, KRV20 Also Fits KFG13, KFG20, KRV7,5, KF7,5, KF13, KF17, KF20 (45mm Drawtubes)	£8.23
800 0031	KFG27, KFG30 Also Fits KRV30, KF27 (50mm Drawtubes)	£8.23
800 0032	KFG35, KFGL35, KRV35 (60mm Draw-tubes)	£8.97

Couplings

DRAW TUBES



Draw Tube Kits to suit Cast Delta, Pressed Steel Delta & Square Tube Couplings Supplied with stop ring

KNOTT

Part No.	Description	Price
800 0020	Fits KFG13-20, KF7-20, KRV7,5-KRV20 (45mm Ø Drawtube)	£65.80
800 0021	Fits KFG27 (Ø12), KF27 (Ø12) (50mm Ø Drawtube)	£77.00
800 0022	Fits KFG27-30 (Ø14), KF27 (Ø14), KRV30 (2x Ø14) (50mm Ø Drawtube)	£88.30
800 0023	Fits KFG30 (Ø12 & Ø14), KRV30 (Ø12 & Ø14) (50mm Ø Drawtube)	£102.40
800 0024	Fits KFG35 (cross bolts) (60mm Ø Drawtube)	£99.90

HANDBRAKE ASSEMBLIES



Handbrake Assemblies for Knott-Avonride Couplings

KNOTT

Part No.	Description	Price
800 0080	Old Style Handbrake Assembly for KFG Series, KF7,5-KF27	£38.37
800 0081	New Style Handbrake Lever c/w Pivot Bolt for KFG Series	£60.68
800 0082	New Style Handbrake Lever c/w Pivot Bolt for KRV7,5-20 60/70/80mm Box Sections	£83.50

HANDBRAKE ENERGY STORES



New Style Black Plastic Energy Stores

KNOTT

Part No.	Description	Price
800 0060	Current Part for KRV7-20, KF7-27	£81.78
800 0061	Current Part for KFG Series, KRV30-35	£80.90

KNOTT BELLOWS KITS



Bellows Kits to suit Knott-Avonride Couplings

KNOTT

Part No.	Description	Price
800 0050	For KRV7,5-30, KF7,5-27 (Also For KFG13 KFG20 KFG27 KFG30 With Eyes)	£6.70
800 0052	For KFG13 KFG20 KFG27 KFG30 (With Heads)	£9.87
800 0053	Fits KFG35 (Heads Only)	£10.20
800 0054	Fits KFG35 (Eyes Only), KRV35 KFGL35	£17.08

LOCKING HANDLES



Replacement Jockey Wheel Lever to suit Knott-Avonride Couplings

KNOTT

Part No.	Description	Price
800 0070	4" Standard Locking Handle	£5.77
800 0071	6" Extended Locking Handle	£6.23
800 0072	Replacement Pressure Pad	£5.85

Prop Stands

PRESSED STEEL BRACKETS



Medium Duty Clamps for Smooth Type Jockey Legs & Prop Stands

Pressed Steel

Part No.	Description	Tube Ø	Price
800 196	PD1 Bracket	34mm	£5.39
800 197	PD2 Bracket	43mm	£4.80
800 198	PD3 Bracket	48mm	£4.95

PROP STANDS - PLAIN TUBE



Trailer Prop Stand / Rear or Front Support Post.
Keeps rear of trailer steady for loading/unloading items

KNOTT

Part No.	Length	Tube Ø	Price
800 101	530mm	34mm	£9.05
800 102	630mm	43mm	£13.80
800 103	750mm	48mm	£18.18
800 900	900mm	48mm	£19.77

CAST LEG BRACKETS



Bracket Assemblies to suit Prop Stands & Jockey Legs

Part No.	Description	Tube Ø	Price
800 116	PD1 Bracket	34mm	£10.67
800 180	PD2 Bracket	43mm	£12.20
800 120	PD3 Bracket	48mm	£32.00
800 124	PD4 Bracket	63mm	£107.50

SPINDLE SUPPORT LEG



Vertical Load: 800kg
60mm x 60mm Square Tube
160mm Dia. Foot
Non-Extended Height: 565mm
Stroke: 320mm
Weight: 7.80kg

KNOTT

Part No.	Price
800 0200	£81.18

BRACKET LEVER & BUSH

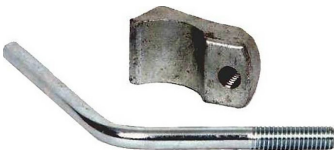

Lever & Bushes to suit PD1 & PD2 Brackets

Lever & Nut to suit PD3 Brackets

Part No.	Description	Fits	Price
800 117	Lever & Bush	PD1 Bracket	£11.95
800 118	Lever & Bush	PD2 Bracket	NLA
800 121	Lever & Nut	PD3 Bracket	£20.29

HINGED SUPPORT LEG



Vertical Load: 1300kg
60mm x 60mm x 4mm Tube
120mm Dia. Foot
Non-Extended Height: 535mm
Stroke: 365mm
Weight: 7.75kg

KNOTT

Part No.	Price
800 0201	£116.70

CONNECTING TUBE



Connecting Tube for Hinged Support Leg (800 0201)

Part No.	Price
800 0202	£14.28

TELESCOPIC PARKING JACKS

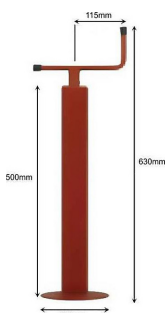

Heavy gauge steel construction Red Oxide Coated

Part No.	Static Load	A	B (min)	B (max)	C	D	Price
200 142	800kg	115mm	460mm	810mm	160mm	60mm	£42.92
200 143	1000kg	175mm	500mm	850mm	160mm	70mm	£51.50
200 144	Weld on Bracket - 17.5mm Hole/127mm Hole Centres						£6.85

Knott Accessories

HUB CAPS

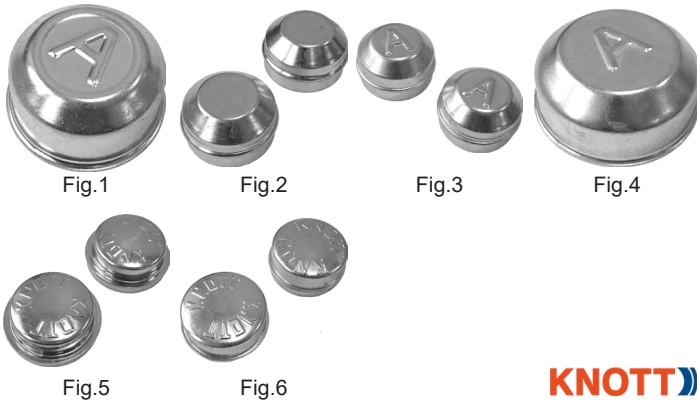

KNOTT

Part No.	Fig.	Description	Price
800 0140	1	R Series Hub - O/D 60.3mm (1pc)	£13.60
800 0139	2	Old N,P,X & New R Series Hub - O/D 52.4mm (2pcs)	£12.05
800 0138	3	A,C,E & F Series Hub - O/D 47.1mm (2pcs)	£13.32
800 0137	4	V & T Series Hub - O/D 74.6mm (1pc)	£8.03
800 0136	5	'Knott' Hub Cap - O/D 64mm (2pcs)	£13.62
800 0135	6	'Knott' Hub Cap - I/D 52mm (2pcs)	£14.25

WHEEL BEARING KITS



KNOTT

Part No.	Fig.	Description	Inner Ø	Price
800 0133	1	V & T Series Hubs	32 & 35mm	£23.98
800 0132	2	C & E Series Hubs	20 & 27mm	£19.48
800 0131	3	C & E Series Hubs	20 & 32mm	£21.10
800 0130	4	N Series Hubs	25.4mm	£20.28
800 0129	5	Taper Roller Bearing	27 & 32mm	
800 0128	6	Bearing Kit	34mm	£49.42
800 0127	7	Bearing Kit	39mm	£46.27
800 0121	8	Flange Nut (x2)	M24	£10.84

BRAKE ADJUSTERS

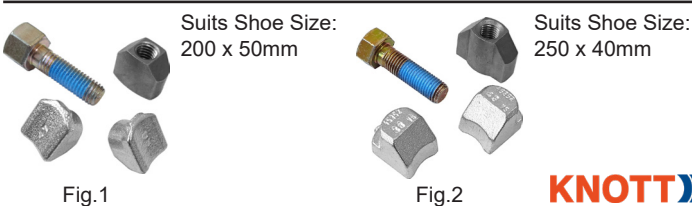

KNOTT

Part No.	Fig.	Description	Price
800 0155	1	Brake Adjuster Kit (Suits 500 502)	£7.20
800 0154	2	Brake Adjuster Kit (Suits 500 501)	£11.87

WHEEL NUT SETS

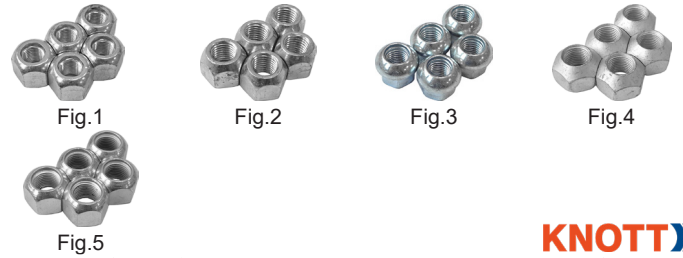

KNOTT

Part No.	Fig.	Description	Price
800 0158	1	3/8" UNF Wheel Nuts - Set of 5	£6.00
800 0150	2	M12 Conical Wheel Nut - Set of 5	£4.88
800 0151	3	M12 Spherical Wheel Nut - Set of 5	£8.22
800 0163	4	M16 Conical Wheel Nut - Set of 5	£7.05
800 0164	5	M16 Spherical Wheel Nut - Set of 5	£16.38

BOLT SETS

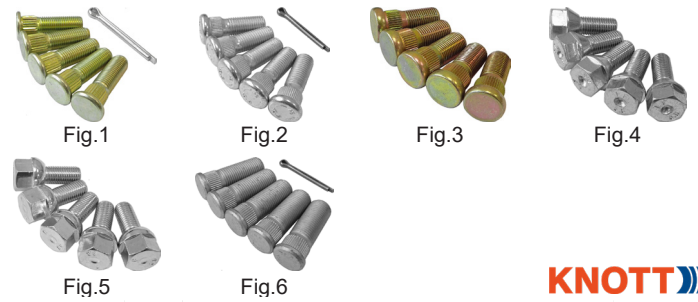

KNOTT

Part No.	Fig.	Description	Price
800 0157	1	3/8" UNF x 34mm Wheel Studs 5x Studs & Split Pin	£9.55
800 0152	2	M12 x 38mm Wheel Studs 5x Studs & Split Pin	£8.83
800 0161	3	5/8" UNF x 37mm Wheel Studs 5x Studs	£8.92
800 0159	4	M12 x 1.5 x 24mm Conical Wheel Bolts, 5x Bolts	£6.38
800 0160	5	M12 x 42mm Spherical Wheel Bolts 5x Bolts	£5.92
800 0162	6	M16 x 46mm Wheel Studs 5x Studs & Split Pin	£10.30

CASTELLATED AXLE NUTS

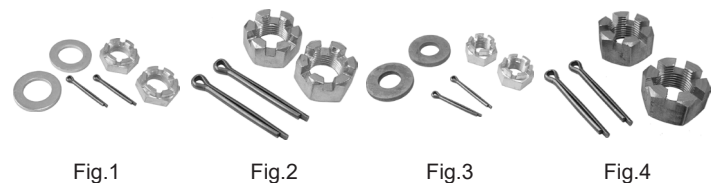

KNOTT

Part No.	Fig.	Description	Size	Price
800 0165	1	Castellated Axle Nut Kit	M24 x 1.5	£25.28
800 0141	2	Castellated Axle Nut Kit	5/8 UNF	
800 0134	3	Castellated Axle Nut Kit	M20	£13.82
800 0142	4	Castellated Axle Nut Kit	3/4"	£19.37

Jockey Wheels

48MM SERRATED JOCKEY



Knott 48mm Serrated Jockey
Max Nose Weight: 300kg
Wheel with 230x65 Tyre

KNOTT

Part No.	Price
800 0100	£60.03

48MM SERRATED JOCKEY



Knott 48mm Serrated Jockey
Max Nose Weight: 350kg
Wheel with 205x50 Tyre

KNOTT

Part No.	Price
800 0101	£52.00

48MM SMOOTH JOCKEY WHEEL



Knott 48mm Smooth Tube
Max Nose Weight: 150kg
200x50mm Jockey Wheel

KNOTT

Part No.	Price
800 0103	£26.00

CAST BRACKETS



Knott Cast Brackets, made of Cast Steel for a Stronger more Durable Jockey Wheel Clamp

KNOTT

Part No.	Description	Price
800 0104	35mm Cast Bracket, 100mm Hole Centres	£10.67
800 0105	42mm Cast Bracket, 100mm Hole Centres	£12.05
800 0106	48mm Cast Bracket, 150mm Hole Centres	£26.73

HEAVY DUTY JOCKEY LEGS



Heavy Duty Ribbed Wind Up Jockey Legs

Part No.	Bradley	Nose Weight	Tube Ø	Price
800 125	TJ17	500kg	63mm (PD4)	NLA
KIT 3623	200mm Replacement Wheel to suit 800 115			£62.25

HEAVY DUTY - BUDGET



Heavy Duty Ribbed Jockey Leg
Tube Diam: 48mm (PD3)
Max Nose Weight: 500kg
225mm Solid Rubber Tyre

Part No.	Price
207 974	£49.00

MEDIUM DUTY JOCKEY LEGS



Medium Duty Telescopic Wind Up Jockey Wheels

Part No.	Type	Nose Weight	Tube Ø	Price
800 112	Plain Tube	100kg	43mm (PD2)	£42.00
800 104	Plain Tube	150kg	48mm (PD3)	£48.22
KIT 143	175mm Replacement Wheel to suit 800 112 & 800 104			£20.50

LIGHT DUTY JOCKEY LEG



Knott Telescopic Wind Up Jockey Wheel
34mm Diam Plain Tube (PD1)
Max Nose Weight: 50kg
205mm Diam Wheel

KNOTT

Part No.	Price
800 111	£32.63

Trailer Wheels



Trailer Wheels

Trailer Wheel Assemblies includes Tyre & Wheel Rim

Part No.	Tyre Size	Rim Ø	PCD	Tyre Rating	Price
800 135	400 x 8	8"	4"	6 Ply	£35.16
800 137	500 x 10	10"	4"	8 Ply	£95.00
800 138	500 x 10	10"	5.1/2"	8 Ply	£82.20
800 139	145 x 10	10"	4"	8 Ply	£61.75
800 140	145 x 10	10"	5.1/2"	8 Ply	£82.30

WHEEL RIMS

Trailer Wheel Rims



Part No.	Rim Type	PCD	Price
800 141	400 x 8	4"	£13.89
800 142	520 x 10	4"	£18.72
800 159	520 x 10	5.1/2"	£25.93

METAL MUDWINGS

Fully Galvanised Metal Trailer Mudguard with rolled edges for safety, strength and rigidity

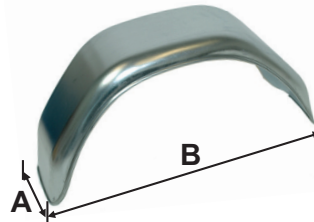

Part No.	A	B	Price
800 192	175mm	605mm	£27.48
800 193	197mm	607mm	£29.44
800 149	142mm	514mm	£25.54
800 150	101mm	355mm	NLA
800 151	200mm	675mm	£29.44
800 152	127mm	431mm	£61.90

PLASTIC MUDWINGS

Injection Moulded Durable Black High Density Polyethylene

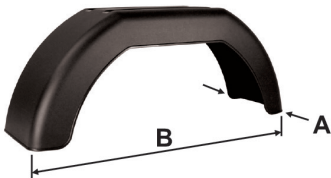

Part No.	A	B	Price
800 143	160	550	£4.42
800 144	180	610	£7.90
800 145	200	770	£14.70

MUDWING BRACKET

Heavy duty fixing bracket for trailer mudguards. Fits to inside or outside edge of plastic trailer mudguard in order to add rigidity compared with fixing the inside face of the mudguard directly to the trailer body

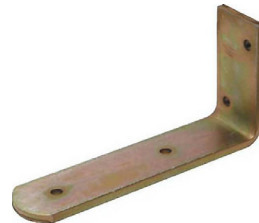

Part No.	Description	Price
804 801	159 x 78 x 40mm wide	£3.26
804 805	208 x 78 x 40mm wide	£3.85

SUSPENSION UNITS

Suitable for 10" Wheels, 4 Stud, 4" PCD

Zinc Plated with Long Life Polyurethane Suspension (Capacity is per Pair)



Part No.	Capacity	Price
800 127	350kg / 7cwt (sold per pair)	£68.47
800 128	500kg / 10cwt (sold per pair)	£86.50
800 129	750kg / 15cwt (sold per pair)	£113.30

TRAILER WHEEL HUB

4 Studs on 4" PCD Complete with Taper Bearings, Studs, Nuts & Dust Cap



Part No.	Price
800 130	£20.57

Trailer Brake Kits

TRAILER WHEEL BEARING



Bearing Set for 1 Hub
Includes 2 Taper Bearings &
Races

Part No.	Price
800 131	£19.21

WHEEL NUTS & STUDS



3/8" UNF Trailer Wheel Nuts
& Studs

Part No.	Description	Price
800 132	3/8" UNF Nut (sold each)	£0.75
800 133	3/8" UNF Stud (sold each)	£1.48

WHEEL BEARING KIT



Wheel Bearing Kit for Bradley
200 & 203 Drums

Part No.	Price
KIT 190	£28.00

METAL DUST CAP



Metal Dust cap for trailer wheel
hubs.

50mm Diameter
(each)

Part No.	Price
800 134	£1.55

8" KNOTT BRAKE SHOE KIT



Brake Shoe Kit for Knott
Axles fitted on Ifor Williams &
other popular trailer brands

Suits 8" Drums
Shoe size: 200 x 40mm
(This kit services 1 axle)



Part No.	Price
500 504	£57.23

10" KNOTT BRAKE SHOE KIT



Brake Shoe Kit for Knott
Axles fitted on Ifor Williams &
other popular trailer brands

Suits 10" Drums
Shoe size: 250 x 40mm
(This kit services 1 axle)



Part No.	Price
500 501	£69.97

8" KNOTT BRAKE SHOE KIT



Brake Shoe Kit for Knott
Axles fitted on Ifor Williams &
other popular trailer brands

Suits 8" Drums
Shoe size: 200 x 50mm
(This kit services 1 axle)



Part No.	Price
500 502	£57.23

8" ALKO BRAKE SHOE KIT



Brake Shoe Kit for ALKO
Axles fitted on older Ifor
Williams & other popular
brands of trailer

Suits 8" Drums
Shoe size: 200 x 50mm
(This kit services 1 axle)

Part No.	Price
500 503	£42.50

Trailer Accessories

FIXED CORNER STEADIES



Fixed Foot Wind-up Corner Steadies 24"
Used on caravans and trailers

Made from untreated mild steel ready for painting

Part No.	Size	Price
800 182	24" Corner Steady	£30.63

19MM WINDING BRACE



19mm Winding up brace for Caravan and trailer corner steadies

19mm socket
720mm total length
300mm winding shank

Made from zinc plated steel
Suits Part No. 800 182

Part No.	Price
800 183	£11.48

TRAILER COVERS



Trailer Covers Cloth Type with Elastic Cord for Securing

Part No.	Size	Price
200 146	4ft x 3 ft	£23.09
200 147	5ft x 3ft	£27.90
200 148	6ft x 4ft	£38.20

TRAILER STORAGE BOX



Lockable Storage Box to suit Ifor Williams Trailers
Checker plate box with fold down handle
Length - 25" (635mm)
Width - 9" (230mm)
Height - 9" (230mm)

Part No.	Price
203 010	£110.40

TARPAULIN



Tarpaulin - Polythene Woven Cover
3.5m x 5.5m

Part No.	Price
895 298	£21.59

BUNGEE STRAPS



Bungi Straps for Load Securing & Tie Down

Part No.	Description	Length	Price
200 543	Straps with Hooks	2 x 24"	£2.09
200 544	Straps with Hooks	2 x 36"	£2.30
124 0123	8mm Bungee Cord	5m	£8.32
124 0124	8mm Bungee Cord	100m	£160.00
124 0125	10mm Bungee Cord	5m	£9.10
124 0126	10mm Bungee Cord	100m	£118.70
200 974	8mm Bungee Hooks (each)		£0.95
200 986	10mm Bungee Hooks (each)		NLA

POLYPROPYLENE ROPE



Blue Polypropylene Rope
Suitable for Load Securing

Part No.	Diameter	Length	Price
FAIRB3060	6mm (1/4")	30m (98ft)	£4.93
B/S80422	7mm (9/32")	30m (98ft)	£7.00
492 911	8mm (5/16")	30m (98ft)	£7.69
705 179	10mm (3/8")	27m (88ft)	£10.73
200 766	10mm (3/8")	30m (98ft)	£12.50
FAIRB30120	12mm (15/32")	30m (98ft)	£17.52
200 773	6mm (1/4")	220m (720ft)	£17.34
200 774	8mm (5/16")	220m (720ft)	£33.30
200 775	10mm (3/8")	220m (720ft)	£48.76
200 776	12mm (15/32")	220m (720ft)	£81.67

POLYPROPYLENE ROPE HASP



Blue Polypropylene Rope on Hasp
Suitable for Load Securing

Part No.	Diameter	Length	Price
FAIRB1010H	10mm (3/8")	10m (32ft)	£6.73
FAIRB6020H	6mm (1/4")	20m (65ft)	£4.86
FAIRB8015H	8mm (5/16")	15m (49ft)	£6.27

Trailer Winches & Tow Ropes

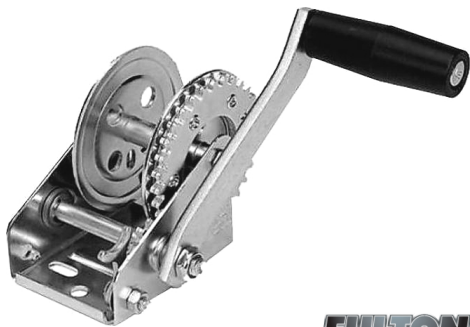

FULTON

Fulton Auto Braked Winches

Fulton K-Series self-activating automatic brake winches. Brake holds the load securely when the crank handle is released. No minimum line load is required to active the brake or pay out cable from the winch. Typical applications include boat lifts, manual fork lifts, retractable swing keels and manual hoists.

Part No.	Load Capacity	Gear Ratio	Max Cable Ø	Price
200 271	454kg (1000lbs)	4.1:1	5.5mm	£154.80
200 270	680kg (1500lbs)	5.1:1	6.0mm	£170.00

DRUM WINCH - 1200LBS



Budget Hand Winch - 1200lbs capacity

Ratchet mechanism (1-way)

Suitable for 4- 6mm wire rope (upto 15m) or 8m of flat strap

Part No.	Price
800 184	£44.17

2500KG TOW ROPE



Maypole 3.5m X 2500kg Tow Rope
Forged Hooks
Flag
"On Tow"
3.5m Cable
Confirms to BSAU187

Part No.	Price
761 557	£9.20

WINCH STRAP WITH HOOK



Winch Strap 7m x 48mm c/w Forged Steel Hook suitable for Budget Hand Winch & Fulton Hand Winch

1500kg breaking strain

Part No.	Price
800 185	£15.02

TOW LINE WITH SHACKLE



High Quality Tow Strap with Yoke & Shackle
Towing Capacity: 5 Tons
Length: 4.5m

Part No.	Price
705 208	£37.92

WIRE ROPE & HOOK



Wire rope complete with Alloy Steel Eye Hook with Safety Catch. Suitable for Fulton & Budget Winches.

Length: 15m

Part No.	Rope Diam.	Price
800 186	5mm	£22.97
800 187	6mm	NLA

3 SECTION TOW POLE



3 Section Tow Pole
6ft Telescopic Rigid Tow Bar
1800Kg
TUV Approved

Part No.	Price
TR489	£28.00

Trailer Hardware

TOGGLE CLAMPS

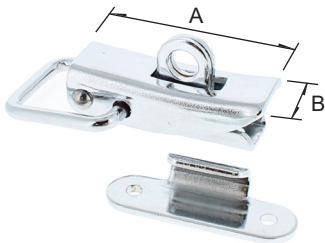

Over Centre Toggle Clamps
Can be secured with lock or pin

Part No.	A	B	Price
200 479	68mm	18mm	£3.47
200 480	68mm	25.4mm	£2.80
200 481	170mm	25.4mm	£5.87

ANTI-LUCE CATCHES



Anti Luce Catches
Zinc Plated

Part No.	Head Size	Thread	Price
800 163	50 x 15 x 4mm	M8 x 20	£1.40
800 164	50 x 15 x 4mm	M8 x 38	£1.70
800 161	70 x 20 x 6mm	M12 x 34	£2.58
800 162	70 x 20 x 6mm	M12 x 72	£3.43

OVERCENTRE CATCHES



Adjustable Overcentre
Catches

Zinc Plated

Part No.	Adjustable Length	Width	Price
800 100	83 - 93mm	30mm	£3.90
800 020	97 - 127mm	32mm	£6.48
800 030	143 - 163mm	40mm	£9.19

BONNET CATCHES



Bonnet Catches
Rubber Latch, Metal Catch

Part No.	Length	Price
803 202	2"	£3.10
803 200	4"	£4.35

13mm Weld On Rope Hook Self Colour Steel	Single Rope Hook Screw Fixing	Straight Hinge for 1/2" Pins 150 x 40 x 8mm Un-drilled	Weld On Gudgeon Pin 2" x 1/2" Peg
200 914 £1.30	200 915 £1.73	201 500 £2.80	705 203 £1.60
Bolt On Gudgeon Pin 2" x 1/2" Peg	Spring Loaded Sword Pin Pin: 90 x 12.5mm	Forged Cotter Pin Zinc Plated	Spring Hook & Chain 75x200mm
705 204 £2.16	200 913 £4.60	200 916 £3.52	705 124 £5.50

Trailer Hardware



Fig.1



Fig.2

Floor Lashing Rings

Mild Steel, Galvanised Back Plate with Forged Steel Ring.

Part No.	Type	Fig.	S.W.L	Price
200 910	Single Recess	1	500kg	£5.26
200 255	Double Recess	2	1000kg	£14.17

SPRING BOLTS



Spring Bolts
Zinc Plated

Part No.	Bolt Ø	Bracket	Throw	Price
200 732	13mm	70 x 40mm	30mm	£3.80
200 733	13mm	114 x 40mm	70mm	£4.45
200 734	16mm	140 x 38mm	82mm	£7.91

BUDGET LOCKS



782 055

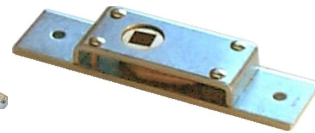

Budget Locks
T-Key Operated

Part No.	Description	Price
782 015	Left Hand	£2.70
782 025	Right Hand	£3.50
782 055	T Key	£1.95

CABIN HOOKS



Cabin hook and catch.
Screw fixing with counter sunk holes.
(screws not included)

Part No.	Length	Price
999 980	150mm	£2.30
999 985	250mm	£1.95

CANOPY LOCK



Canopy Lock With 2 Keys.
Chrome Plated c/w spiked washer, fixing nut and 2 keys.
Body Diameter 19mm
Overall length 34mm
Arm length 36mm

Part No.	Description	Price
224 410	Canopy Lock	£6.40
224 510	Canopy Lock - Keyed Alike	£9.01
64001	Replacement Key	£1.60

CANOPY DOOR HANDLE



Chrome plated locking
Canopy Door Handle
complete with 2 keys

Part No.	Description	Price
800 1255	Door Handle	£21.90
4222/707	Door Handle - Keyed Alike	£20.58

CANOPY DOOR T-HANDLE



Chrome plated locking
T-Handle complete with
2 keys (64001)

360 degree rotation with
no stops

Part No.	Description	Price
200 482	Door Handle	£18.20
64001	Replacement Key	£1.60

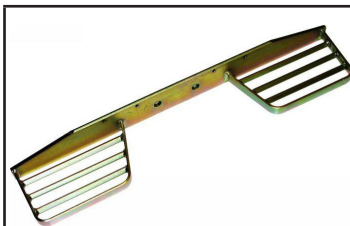

Double Rear Van Step
90mm Hole Centres

800 050 **£26.95**



Gravelly Fastener
Chrome Plated

662 001 **£4.55**

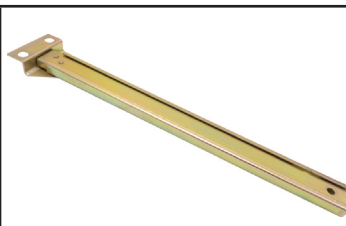

Telescopic Bonnet Lid Stay
Open: 490mm/Closed: 285mm

200 483 **£9.82**

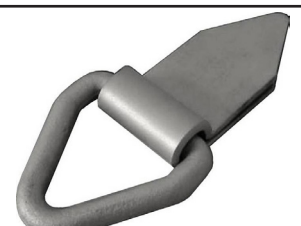

Weld on Lashing Ring
1 Tonne S.W.L

200 911 **£6.20**

Vehicle Security



Bulldog DC400 Wheel Clamp

Bulldog DC400 Autoclamp for Motorhomes and Vans
Lightweight and fully adjustable simple to use and fit
Case hardened top arms for added security

Wheel Diam: 480 - 640mm
Wheel Width: 145 - 205mm (inc nuts)



Part No.	Description	Price
200 487	Dc400 Wheel Clamp	£174.10
200 494	Spare Key (please supply serial number)	£13.50



Bulldog CA2000C Wheel Clamp

Bulldog CA2000C Heavy Duty Adjustable Wheel Clamp
High security drill and pick resistant lock
Protects wheel nuts. Highly Recommended for alloy wheels
'Sold Secure' Gold Approval, Insurance Approved

Wheel Diam: 640 - 760mm
Wheel Width: 175 - 260mm (inc nuts)



Part No.	Description	Price
200 1542	CA2000C Wheel Clamp	£296.30
200 494	Spare Key (please supply serial number)	£13.50

REMOVABLE SECURITY POST

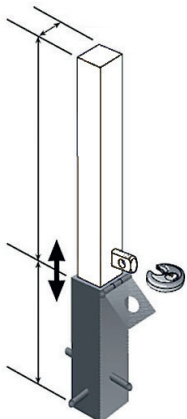

White powder coated security post complete with 82/70 Abus shutter padlock & 2 keys

Two piece construction
Lifts out of the ground when access is required
Secure with padlock to prevent access

FOLDING SECURITY POST



Galvanised steel security post
Supplied with 26/70 Abus Diskus Padlock & 2 keys

Bolt down type security post which tilts flat when not in use

When in use can be secured with padlock to prevent access to building or area

Tube Dia. 60mm
Height. 750mm

Part No.	Price
200 744	£55.00

Part No.	Price
200 743	£44.55

Jacks & Wheel Chocks



3 Tonne Heavy Duty Trolley Jack

Manufactured to EN 1494 specifications
Heavy Duty Design
Steel Lifting Saddle
American Style Release Mechanism
Fitted with heavy-duty rear swivelling steel castor wheels and large saddle to aid positioning
Includes safety overload and bypass valves to prevent the handle locking at maximum extension

Lifting Range: 132mm - 472mm
Overall Size: 620 x 350 x 180mm
Handle Length: 900mm

Part No.	Price
200 041	£207.50

TROLLEY JACK 2 TONNE



Lightweight, Portable Hydraulic Trolley Jack.

Manufactured to EN1494 spec

Capacity: 2000kg
Range: 130 - 330mm
Size: 440 x 200 x 140mm

Part No.	Price
200 705	£58.73

AXLE JACK STANDS



Professional Ratchet Type Axle Jack Stands

- Formed steel frame construction
- Saddle column with handle for easy adjustment
- Stepped height adjustment

Supplied in pairs

Part No.	Capacity	Min Height	Max Height	Price
200 695	3,000kg	300mm	430mm	£58.95
200 696	6,000kg	380mm	595mm	£78.95

HEAVY DUTY WHEEL CHOCK



Heavy Duty Rubber Wheel Chock Moulded from Heavy Duty Industrial Strength Thermoplastic Rubber

Suitable for Tyres up to 44"

Length: 235mm
Width: 160mm
Height: 195mm

Part No.	Description	Price
969 293	Rubber Wheel Chock	£38.45

SEALEY BOTTLE JACKS



Sealey Single Stage Bottle Jacks.

Base and Reservoir Machine Welded for Increased Strength and Reduced Chance of Leakage. Fitted with Overload Valve. Supplied with a Handle.



Part No.	Capacity	Price
SEASJ2	2,000kg	£31.95
SEASJ3	3,000kg	£36.95
SEASJ5	5,000kg	£42.95
SEASJ8	8,000kg	£54.95
SEASJ10	10,000kg	£65.47
SEASJ12	12,000kg	£71.95
SEASJ15	15,000kg	£81.60
SEASJ20	20,000kg	£96.00
SEASJ30	30,000kg	£166.10
SEASJ50	50,000kg	£221.50

LIGHT DUTY WHEEL CHOCK



Light Duty Plastic Wheel Chock

Length: 220mm, Width: 90mm, Height: 100mm

Part No.	Description	Price
969 290	Light Duty Wheel Chock	£5.20
969 297	Wall Mounted Holder Kit	£5.45

HEAVY DUTY WHEEL CHOCK



Heavy Duty HDPE Plastic Wheel Chock Meets EU standard of DIN76051-53, Suitable for Truck Use.

Length: 470mm, Width: 195mm, Height: 240mm

Part No.	Description	Price
969 291	Heavy Duty Wheel Chock	£19.30
969 296	Large Wheel Chock Holder	£24.40

Wheel & Tyre Accessories



Wheel Nut Indicators

CHECKPOINT® is the modern, low cost solution to a long standing operational and management need in the transport industry of implementing and maintaining a low cost, effective procedural system that will allow the checking of wheel nuts for tightness, accurately and economically. The fitting of CHECKPOINT® facilitates these checks within a daily walk round, zero defect reporting procedure.

CHECKPOINT® may be fitted Point to Point, Elephant File, in Echelon or Patterned Configuration to suit the workshop and user.

The size below refers to the 'across the flats' hexagonal dimension of the wheel nut. An accurate means of measuring the wheel nut size is to use a socket

Part No.	Size	Price
310 017	17mm	£0.40
310 018	18mm	£0.40
200 183	19mm	£0.40
310 020	20mm	£0.40
310 021	21mm	£0.40
310 022	22mm	£0.40
310 023	23mm	£0.40

Part No.	Size	Price
310 024	24mm	£0.40
310 025	25mm	£0.40
310 026	26mm	£0.40
310 027	27mm	£0.40
310 028	28mm	£0.40
310 029	29mm	£0.40
310 030	30mm	£0.40

Part No.	Size	Price
310 031	31mm	£0.40
310 032	32mm	£0.40
310 033	33mm	£0.40
310 034	34mm	£0.40
310 035	35mm	£0.40
310 036	36mm	£0.40
310 038	38mm	£0.40
310 040	40mm	£0.40
310 041	41mm	£0.40

50mm Short Reach Valve c/w Cap (25 Pack)	65mm Long Reach Valve c/w Cap (10 Pack)	75mm Tyre Valve Extension	100mm Tyre Valve Extension	Plastic Valve Caps Pack of 100					
405 306	£5.97	405 307	£4.63	405 219	£6.43	405 255	£8.14	405 301	£2.47
Valve Extension - 22mm (ribbed, not threaded)	Tyre Valve Cores Short Type - Pack of 25	Tyre Valve Cores Long Type - Pack of 10	Assorted Valves, Cores & Extensions - Pack of 115	Ass. Repair Patches & Cement - 33 Pieces					
405 304	£1.64	405 302	£5.35	405 303	£2.92	105 183	£34.18	105 178	£20.72
Valve Core Screwdriver Removes Seized Cores	Valve Mounting Tool Screw On Type	Tyre Valve Tool Re-threads Valve Stems Removes Damaged Cores	Metal Foot Pump - Preset Dial Gauge, Single Steel Barrel	Faithfull Low Volume Tyre Inflator 12V					
405 211	£1.30	405 210	£8.00	805 134	£4.85	805 184	£12.85	FAIAUTYINFL0	£17.73

Wheel & Tyre Accessories

PUNCTURE REPAIR SEALANT



25 Litre Drum - Construction grade water-based puncture sealant that will seal up to 16mm holes in all sizes of construction tyres

Part No.	Price
962 015	£175.00

TYRE PRESSURE GAUGE



5-50psi, Pencil type gauge with psi scale, Features valve deflator and pocket clip and is Suitable for use as a guide.

Part No.	Price
SEATSTPG1	£3.93

TYRE REPAIR STRING



Tyre Repair String 12" Black Tubeless Tyre Repair Seal String Rubber Filler Strips

Part No.	Price
899 022	£14.20

TYRE REPAIR PATCHES



Tyre Tube Repair Patches

Part No.	Size	Pack Size	Price
405 351	45mm Round	20	£7.15
405 352	60mm Round	10	£5.92
405 353	80mm Round	5	£5.18
405 354	55mm Square	5	£4.12

RUBBER SOLUTION



Vulcanising Rubber Solution
Rubber Repair Solution (Cement)

Part No.	Size	Price
405 355	15g Tube	£2.55
405 205	250ml Tin	£11.90

1/2" DRIVE TORQUE WRENCH



Reversible ratchet head.

Range: 27-204Nm(20-150lb.ft)
Overall length 465mm.

Part No.	Price
290 038	£62.22

YELLOW CRAYON



All Surface Yellow
Marker Crayon

Part No.	Price
895 110	£2.40

EXTENDABLE WHEEL WRENCH



Extendable Wheel Wrench

Complete with 17, 19 21 & 23mm sockets

Part No.	Price
TR762	£9.25

TYRE REPAIR LIQUID



Tyre Sealant Instant Repair Liquid
Protection for the life of the tyre

1Litre

Part No.	Price
962 010	£8.64

TYRE LEVER (PAIR)



Professional Tyre Lever - 1 Pair
Length: 400mm

Part No.	Price
200 052	£36.64

TYRE BEAD PASTE



Easi-Lube Tyre Bead Paste

5kg Tub

Part No.	Price
895 422	£9.20

4-WAY WHEEL WRENCH



4 Way Wheel Nut Wrench
17mm, 19mm, 21mm & 22mm

Part No.	Price
365-05	£11.28

Battery Chargers

8 AMP BATTERY CHARGER



Output: 6v/12v 8 Amp effective
Suitable for 6V/12V lead acid & AGM batteries up to and over 1.8lt.
1.7m leads with inline fuse protection and fully insulated crocodile clips
Suitable for start/stop vehicles.

Part No.	Price
200 160	£32.08

15 AMP BATTERY CHARGER



Sealey 15Amp 12V Intelligent Speed Charge Battery Charger.
Charges conventional lead acid, calcium, AGM/GEL, leisure and stop/start batteries.

Part No.	Price
SEASPI15S	£137.20

20 AMP START CHARGER



SIP 20 Amp Start Charger
Nett Weight: 7.00kg
Output: 12/24V
Output Charge Peak(EN): 21A(14A)
Output Start Peak(EN): 140A(80A)
Battery Range: 15-240Ah
Input Charge: 2.7A
Input Start: 11A
Charging Rates: 3
Supply: 230V

Part No.	Price
200 161	£189.20

30 AMP START CHARGER



Durite 12/24V 30 amp heavy duty bench start assist/charger with charge timer for professional use. 'Automatic' or 'Manual' and high or low charge rate options with 100 amp 'Start Assist' and thermal auto-rest overload protection.
Powder coated steel case.
Supplied with charging leads, crocodile clips and mains plug.

Part No.	Price
064 830	£383.30

40 AMP START CHARGER



SIP 40 Amp Start Charger
Standard 230v supply
Dual voltage; 12.0v / 24.0v
40amp output current at 12.0v
20amp output current at 24.0v
Three different charging modes
Manual operation for quick custom and recall them for future operations
Automatic mode for quick charging

Part No.	Price
845 3974	NLA

AUTO BATTERY TESTER



Durite Spark arresting discharge tester for use on 12V lead-acid automotive batteries up to 120 amp hours, discharging them at 250 amps at 9V.
Flexible legs adjust to all sizes of battery.
Adjustable angled meter for easy reading.

Part No.	Price
200 163	£177.60

BATTERY ACID TESTER



Gives a simple and quick check of battery state of charge

Part No.	Price
295 230	£3.20

ANTI FREEZE TESTER



Gives a simple and quick check of anti-freeze content and protection

Part No.	Price
895 139	£5.41

Jump Leads

HEAVY DUTY JUMP LEADS



Suitable for 12v/24v cars and light commercial vehicles up to 2000cc
16mm² heavy duty cable

Length: 3m
Maximum Capacity: 300Ah

Part No.	Price
295 229	£26.39

JUMP LEAD HANDLES



Jump Lead Handles
2 Red & 2 Black Coloured
Insulated Plastic

Peak Output: 400 Amps
Starting Output: 250 Amps

Part No.	Price
295 222	£13.70

12V BATTERY TERMINALS



12v Light Duty
Battery Terminals
Zinc Plated Brass

Part No.	Type	Price
205 223	Positive	£2.64
205 224	Negative	£2.64

24V BATTERY TERMINALS



24v Heavy Duty
Battery Terminals
Zinc Plated Brass

Part No.	Type	Price
205 225	Positive	£2.93
205 226	Negative	£2.93

EX HEAVY DUTY JUMP LEADS



Suitable for 12v/24v cars and commercial vehicles up to 8000cc, 35mm² heavy duty

4 Metre cable
Peak Output: 850 Amps
Starting Output: 500 Amps

Part No.	Price
200 153	£75.88

12V ROADSTART POWER PACKS



RoadStart Emergency Power
Packs - 12v

Fitted with 12v power socket.
Supplied with mains charger
and double plug adaptor for
in-car charging.

Part No.	Peak Amps	Batteries	Price
064 102	1600	1	£244.90
064 103	3200	2	£466.00

TERMINAL ADAPTORS



Battery Terminal Adaptors for
Japanese Engines

Part No.	Description	Price
205 229	Negative Terminal Adaptor	£1.58
205 230	Positive Terminal Adaptor	£1.58

CABLE LUGS



Copper Tube Spade End
Terminals

Part No.	Cable	Ring Ø	Price
205 234	25mm ²	6mm	£0.38
205 235	25mm ²	8mm	£0.38
205 236	25mm ²	10mm	£0.40
205 237	70mm ²	10mm	£1.20

QUICK RELEASE TERMINALS



Quick Release Battery
Terminals - 1 pair
Copper Zinc for top post
batteries
Fits most cable sizes
For smaller cables reverse
the cable locking clamp

Part No.	Price
200 885	£9.50

Battery Accessories

TERMINAL PROTECTOR 400ML



Cleans corrosive deposits which build up on battery terminals
- Provides effective protection of battery & electrical terminals
- Repels moisture & maintains best possible contact
- Protects against corrosion, acid & general weathering effects
- Ensures best possible connections

Part No.	Price
FX081126	£3.98

BATTERY CARRIER



Universal battery carrier with tubular steel handle and comfort grip.

Enables fast, safe handling of batteries.

Fully adjustable for battery size

Part No.	Price
200 152	£18.17

BATTERY RETAINERS (5 PACK)



Battery Retaining Bracket Set
Universal Fitting Stays & Nuts
Zinc Plated

5 Sets

Part No.	Price
295 227	£14.01

BATTERY CHARGING AREA



Size - 240mm x 360mm
(9" x 14 1/4")

Part No.	Type	Price
WB054A	Self Adhesive	£12.30
WB054F	Foamex (3mm)	£19.04

BATTERY ISOLATOR SWITCH



Medium Duty Battery Isolator Switch

Connection to either positive or negative lead

100 Amp continuous rating

Part No.	Type	Price
200 026	Switch Unit & Key	£5.50
200 182	Spare Key	£1.60

BATTERY CLEANING BRUSH



Cleaning Brush Tool for cleaning standard battery posts and terminals

Part No.	Price
355 1679	£5.74

H/DUTY ISOLATOR SWITCH

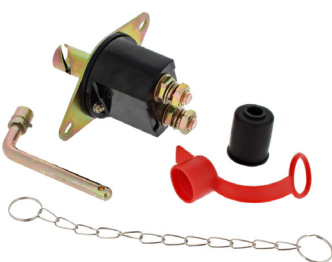

Heavy Duty Battery Isolator Switch

Rating 250Amps at 24Volts,
500Amps for 5 seconds

Supplied with single metal key

Part No.	Type	Price
200 027	Switch & 1 Key	£19.95
200 180	Spare Key	£5.60

DE-IONISED WATER



De-ionised water for car battery maintenance

Part No.	Size	Price
030 001	1 Ltr	£0.98
030 005	5 Ltr	£3.95

Auto Cable

1MM² SINGLE CORE CABLE



1mm² Single Core Auto Cable
14/030. 8.75 amp

50m Rolls

Part No.	Colour	Price
215 166	Red	£14.80
215 167	Black	£14.80
215 168	Blue	£14.80
215 169	Green	£14.80
215 170	Yellow	£14.80
215 171	Brown	£15.24
215 172	White	£14.80

1MM² TWIN CORE CABLE



1mm² Twin Core Auto Cable
2 x 14/030. 8.75 amp

30m Roll

Part No.	Price
124 0319	£21.77

2MM² TWIN CORE CABLE



2mm² Twin Core Auto Cable
2 x 28/030. 17.50 amp

30m Roll

Part No.	Price
215 183	£42.95

2MM² SINGLE CORE CABLE



2mm² Single Core Auto Cable
28/030. 17.50 amp

50m Rolls

Part No.	Colour	Price
215 173	Red	£25.48
215 174	Black	£25.48
215 175	Blue	£25.48
215 176	Green	£25.48
215 177	Yellow	£29.51
215 178	Brown	£25.48
215 179	White	£25.48

TWIN CORE SPEAKER CABLE



0.4mm² Twin Core Speaker
Cable, 2 x 44/030. 27.50 amp

100m Roll

Part No.	Price
215 184	£37.22

7 CORE TRAILER CABLE 10M ROLL



7 Core Trailer Cable For
Caravans and Trailers
Suitable for 12v Applications
10m Roll

Part No.	Price
124 0165	£16.50

3MM² SINGLE CORE CABLE



3mm² Single Core Auto Cable
44/030. 27.50 amp

30m Rolls

Part No.	Colour	Price
215 192	Black	£27.18
215 193	Brown	£26.43
215 180	Red	£27.25

7 CORE TRAILER CABLE 30M ROLL



Black PVC 7 Core Cable for
Trailers - 5.75 amp

30m Roll

Part No.	Price
215 221	£56.88

4.5MM² SINGLE CORE CABLE



4.5mm² Single Core Auto Cable
65/030. 35 amp

30m Roll - Red

Part No.	Price
215 181	£36.00

25MM² STARTER CABLE



25mm² Starter Cable - Light Duty
37/090. 12v Applications 170 Amp

10m Rolls

Part No.	Colour	Price
215 231	Red	£75.44
215 232	Black	£75.60

Pre Insulated Crimp Terminals

Pre Insulated Terminal Size Guide

 Red - Cable Dia. 0.5 - 1.5mm²

 Blue - Cable Dia. 1.5 - 2.5mm²

 Yellow - Cable Dia 2.5 - 6.0mm²

BUTT CONNECTORS



Standard Butt Connectors

Part No.	Colour	Pack	Price
205 148	Red	100	£3.75
205 149	Blue	100	£3.33
205 150	Yellow	50	£2.89

FEMALE SPADE TERMINALS



Fully Insulated Female Spade
Terminals

Fits Tab 6.3mm

Part No.	Colour	Pack	Price
205 103	Red	100	£5.26
205 106	Blue	100	£5.55
205 109	Yellow	50	£3.31

BUTT CONNECTORS



Heat Shrink Butt Connectors
Adhesive Lined

Part No.	Colour	Pack	Price
205 165	Red	1	£0.63
205 166	Blue	1	£0.63
205 167	Yellow	1	£0.63

MALE SPADE TERMINALS



Male Spade Terminals
6.3mm Tab

Part No.	Colour	Pack	Price
205 104	Red	100	£3.75
205 107	Blue	100	£3.90
205 110	Yellow	50	£2.69

PIGGY BACK TERMINALS



Male Piggy-Back Terminals
Fits Tab 6.3mm

Part No.	Colour	Pack	Price
205 114	Red	100	£5.58
205 115	Blue	100	£5.65

FEMALE BULLET TERMINALS



Female Receptacle Sockets

Part No.	Colour	Bullet	Pack	Price
205 141	Red	4mm	100	£4.90
205 143	Blue	5mm	100	£5.15

FEMALE SPADE TERMINALS



Female Spade Terminals

4.8mm Terminals suitable for
Speaker & Headlight Connections

Part No.	Colour	Spade	Pack	Price
205 111	Red	4.8mm	100	£4.00
205 112	Blue	4.8mm	100	£3.85
205 102	Red	6.3mm	100	£4.25
205 105	Blue	6.3mm	100	£4.00
205 108	Yellow	6.3mm	50	£2.90
205 101	Yellow	9.5mm	50	£4.74

MALE BULLET TERMINALS



Male Bullet Terminals

Part No.	Colour	Bullet	Pack	Price
205 142	Red	4mm	100	£4.00
205 144	Blue	5mm	100	£4.08

Pre Insulated Crimp Terminals

RING TERMINALS

Ring Terminals



Part No.	Colour	Ring Diam.	Pack	Price
205 136	Red	8mm (5/16")	100	£4.39
205 124	Red	3mm (6BA)	100	£3.50
205 127	Red	3.5mm (4BA)	100	£3.50
205 130	Red	5mm (2BA)	100	£3.50
205 133	Red	6mm (0BA)	100	£4.10
205 137	Blue	8mm (5/16")	100	£4.35
205 139	Blue	10mm (3/8")	100	£4.93
205 125	Blue	3mm (6BA)	100	£3.75
205 128	Blue	3.5mm (4BA)	100	£3.75
205 131	Blue	5mm (2BA)	100	£4.00
205 134	Blue	6mm (0BA)	100	£4.48
205 138	Yellow	8mm (5/16")	50	£4.53
205 140	Yellow	10mm (3/8")	50	£4.35
205 299	Yellow	12mm (1/2")	50	£6.28
205 129	Yellow	3.5mm (4BA)	50	£2.85
205 132	Yellow	5mm (2BA)	50	£3.10
205 135	Yellow	6mm (0BA)	50	£3.74

FORK TERMINALS

Fork Terminals



Part No.	Colour	Fork Diam	Pack	Price
205 116	Red	3.5mm (4BA)	100	£3.50
205 120	Red	5mm (2BA)	100	£3.60
205 118	Blue	3.5mm (4BA narrow)	100	£3.65
205 121	Blue	5mm (2BA)	100	£3.75
205 123	Blue	6mm (0BA)	100	£5.00

SLEEVE TERMINALS

Black Sleeve Terminals



Part No.	Description	Pack	Price
205 154	Single Sleeve Terminal	100	£9.65
205 155	Double Sleeve Terminal	100	£22.48
205 156	Brass Bullets to suit	200	£45.29

SCOTCHLOCK TAP CONNECTORS



Part No.	Description	Pack	Price
205 162	Red - 905 (0.8 - 2.0mm ²)	100	£5.60
205 161	Blue - 560 (1.0 - 2.0mm ²)	100	£7.10

CRIMPING PLIERS

Light Duty Crimping Pliers & Wire Stripper with Insulated Handles



Part No.	Price
295 160	£4.40

RATCHET CRIMPING PLIERS

Heavy Duty Ratchet Crimping Pliers with Insulated Handles



Part No.	Price
200 779	£17.50

HEAVY DUTY CRIMPING PLIERS

Heavy Duty Crimping Pliers & Wire Stripper with Insulated Handles



Part No.	Price
295 157	£14.33

UNISTRIPPER TOOL

Unistripper Tool, Fast Action Crimper & Wire Stripper with Insulated Handles



Part No.	Price
295 162	£15.13

Auto Fuses

GLASS AUTO FUSES



Glass Auto Fuses

Part No.	Size	Pack	Price
235 241	2 Amp	100	£6.60
235 242	5 Amp	100	£6.60
235 243	10 Amp	100	£6.60
235 244	15 Amp	100	£6.60
235 235	20 Amp	100	£6.92
235 245	25 Amp	100	£6.60
235 246	35 Amp	100	£6.60
235 247	50 Amp	100	£6.60

CONTINENTAL AUTO FUSES



Continental Ceramic Fuses

Part No.	Size	Pack	Price
235 248	5 Amp	100	£15.50
235 249	8 Amp	100	£15.52
235 250	16 Amp	100	£15.52
235 251	25 Amp	100	£15.52

MINI BLADE FUSES



Mini Blade Fuses
10mm across the top

Part No.	Size	Colour	Pack	Price
235 271	2 Amp	Grey	25	£2.35
235 272	3 Amp	Violet	25	£2.35
235 273	4 Amp	Pink	25	£2.35
235 274	5 Amp	Beige	25	£2.35
235 275	7.5 Amp	Brown	25	£2.35
235 276	10 Amp	Red	25	£2.35
235 277	15 Amp	Blue	25	£2.35
235 278	20 Amp	Yellow	25	£2.35
235 279	25 Amp	Clear	25	£2.35
235 280	30 Amp	Green	25	£2.35

STANDARD BLADE FUSES



Standard Blade Fuses
19mm across the top

Part No.	Size	Colour	Pack	Price
235 311	2 Amp	Grey	50	£5.73
235 312	3 Amp	Violet	50	£5.78
235 313	4 Amp	Pink	50	£5.78
235 314	5 Amp	Beige	50	£5.78
235 315	7.5 Amp	Brown	50	£5.78
235 416	10 Amp	Red	100	£5.55
235 417	15 Amp	Blue	100	£11.07
235 318	20 Amp	Yellow	50	£5.78
235 319	25 Amp	Clear	50	£5.78
235 320	30 Amp	Green	50	£5.78

MAXI BLADE FUSES

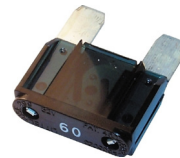

Maxi Blade Fuses
30mm across the top

Part No.	Size	Colour	Pack	Price
235 571	20 Amp	Yellow	10	£12.03
235 572	30 Amp	Green	10	£12.03
235 573	40 Amp	Amber	10	£7.15
235 574	50 Amp	Red	10	£6.70
235 575	60 Amp	Blue	10	£6.65
235 576	70 Amp	Tan	10	£7.15
235 577	80 Amp	Natural	10	£7.15

RADIO MINI FUSES



Mini Glass 'Radio' Fuses

Part No.	Size	Pack	Price
235 239	2 Amp	1	£0.15
235 236	5 Amp	1	£0.20

Fuse & Bulb Holders

BLADE FUSE TESTER



Blade Fuse Tester & Extractor
For Standard Size & MINI Blade
Fuses

Part No.	Price
235 309	£4.90

BLADE FUSE HOLDER



Blade Fuse Holder with Male
Side Tabs for Standard Blade
Fuses
Pack of 10

Part No.	Price
235 253	£6.35

INLINE FUSE HOLDER



Glass & Ceramic Fuse Holder
with Terminal Ends
Pack of 10

Part No.	Price
235 260	£8.87

BLADE FUSE HOLDER

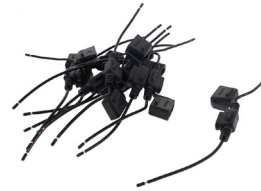

Splashproof Blade Fuse Holder
For Standard Blade Fuses
Pack of 10

Part No.	Price
235 254	£18.92

BLADE FUSE HOLDER



Blade Fuse Holders for Standard
Size Blade Fuses
Pack of 10

Part No.	Price
235 252	£6.88

FUSETAP & HOLDER



Add-A-Circuit Style Blade Fuse
Holder
Fusetap & Holder for Installing
Additional Accessories without
Splicing. Fuse Rating: 10A

Part No.	Price
235 306	£4.50

BLADE FUSE HOLDER

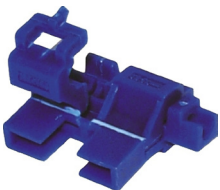

Self Stripping Blade Fuse Holder
For Standard Size Blade Fuses
Pack of 20

Part No.	Price
235 308	£14.02

BULB HOLDER FOR H1 BULB

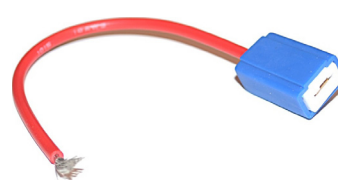

Bulb Holder for H1 Type Bulbs

Part No.	Price
070 521	£2.15

BLADE FUSE HOLDER



Blade Fuse Holder 30 Amp with
Orange Cables

Part No.	Price
235 703	£2.02

BULB HOLDER FOR H7 BULB



Bulb Holder for H7 Type Bulbs

Part No.	Price
070 523	£2.58

Auto Bulbs



Part No.	Fig.	Type	Application	Volts	Watts	Price
LLB448	1	H1 Cap P14.5s (Xenon)	Headlight, Flashing Beacon	12	55	£1.80
LLB466	1	H1 Cap P14.5s (Halogen)	Headlight, Flashing Beacon	24	70	£3.00
LLB453	2	H3 Cap P22s (Xenon)	Headlight	12	55	£1.90
LLB460	2	H3 Cap P22s (Halogen)	Headlight	24	70	£2.90
LLB472	3	H4 Cap P43t (Xenon)	Headlight	12	60/55	£2.04
LLB475	3	H4 Cap P43t (Heavy Duty)	Headlight	24	75/70	£4.20
LLB477	4	H7 Cap PX26d (Halogen)	Headlight	12	55	£3.45
LLB775	4	H7 Cap PX26d (Halogen)	Headlight	24	70	£6.60
LLB012	5	H4 Cap P45t (Halogen)	Headlight	12	60/55	£4.35
LLB410	6	UAC P45t (Standard Filament)	Headlight	12	45/40	£1.40
LLB382	7	BA15s SCC (Standard Filament)	Stop/Tail/Indicator	12	21	£0.46
LLB339	7	BA15s SCC (Standard Filament)	Stop/Tail/Indicator	24	24	£0.80
LLB290	7	BA15s SCC (Heavy Duty)	Stop/Tail/Indicator	24	21	£0.90
LLB335	8	BA15d SBC (Standard Filament)	Stop/Tail/Indicator	12	21	£0.62
LLB346	8	BA15d SBC (Standard Filament)	Stop/Tail/Indicator	24	21	NLA
LLB333	8	BA15d SBC (Standard Filament)	Stop/Tail/Indicator	24	24	£0.92
LLB381	8	BA15d SBC (Standard Filament)	Stop/Tail/Indicator	12	5	£1.20
LLB291	8	BA15d SBC (Heavy Duty)	Stop/Tail/Indicator	24	21	£1.00
LLB581	9	BAU15s SCC (Offset Pin)	Indicator	12	21	£1.36
LLB380	10	BAY15d SBC (Offset Index)	Stop/Tail/Indicator/Fog	12	21/5	£0.46
200 108	10	BAY15d SBC (Offset Index)	Stop/Tail/Indicator/Fog	24	21/5	£1.05
LLB207	11	BA15s SCC	Sidelight	12	5	£0.40
LLB149	11	BA15s SCC	Sidelight	24	5	£0.40
LLB245	11	BA15s SCC	Sidelight	12	10	£0.52
LLB246	11	BA15s SCC	Sidelight	24	10	£0.54
LLB248	11	BA15s SCC (Heavy Duty)	Sidelight	24	5	£0.72
LLB233	12	BA9s MCC (8.5mm Dia)	Sidelight/Instrument	12	4	£0.40
LLB249	12	BA9s MCC (8.5mm Dia)	Sidelight/Instrument	24	4	£0.40
LLB209	13	BA15d SBC	Sidelight	12	5	£0.50
LLB150	13	BA15d SBC	Sidelight	24	5	£0.35
LLB989	14	BA9A G15 (15mm Dia)	Sidelight/Instrument	12	5	£0.60
LLB501	15	Wedge Base w2.1 x 9.d Capless	Sidelight/Instrument	12	5	£0.39
LLB504	15	Wedge Base w2.1 x 9.d Capless	Sidelight/Instrument	12	3	£0.60
LLB505	15	Wedge Base w2.1 x 9.d Capless	Sidelight/Instrument	24	3	£0.70
LLB507	15	Wedge Base w2.1 x 9.d Capless	Sidelight/Instrument	24	5	£0.50
LLB281	16	BA7s MCC	Instrument	12	2	£0.50
LLB283	16	BA7s MCC	Instrument	24	3	£0.40

Auto Bulbs



Fig.1

Fig.2

Fig.3

Part No.	Fig.	Type	Application	Volts	Watts	Price
LLB987	1	MES E10	Instrument	12	2.2	£0.80
LLB286	2	Wedge Base W2 x 4.6d Capless	Instrument	12	1.2	£0.40
LLB508	2	Wedge Base W2 x 4.6d Capless	Instrument	24	1.2	£0.80
LLB239	3	Festoon SV8,5-8. 11mm Dia x 38mm	Instrument	12	5	£0.40
LLB242	3	Festoon SV8,5-8. 11mm Dia x 38mm	Instrument	24	5	£0.53

12V H1/H7 BULB KIT



Sturdy Plastic Case for Storing Bulbs & Fuses

Kit Includes:
LLB448, LLB499, LLB207, LLB501
LLB581, LLB566, LLB239, LLB233
Plus Assorted Blade Fuses

Part No.	Price
740 723	£6.27

24V H4 BULB KIT



Sturdy Plastic Case for Storing Bulbs & Fuses

Kit Includes:
LLB475, LLB346, LLB241, LLB249
LLB149, LLB150
Plus Assorted Blade Fuses

Part No.	Price
740 052	£10.28

24V H1/H7 BULB KIT



Sturdy Plastic Case for Storing Bulbs & Fuses

Kit Includes:
LLB449, LLB466, LLB149, LLB150
LLB507, LLB241, LLB334, LLB242
LLB249, LLB246
Plus Assorted Blade Fuses

Part No.	Price
740 724	£9.70

INDICATOR LIGHTS



Warning/Indicator Lights

6.3mm Terminals

Part No.	Colour	Price
125 3001	Green	£4.24
125 3002	Amber	£4.24
060 905	Red	£3.82

12V H4 BULB KIT



Sturdy Plastic Case for Storing Bulbs & Fuses

Kit Includes:
LLB472, LLB382, LLB207, LLB380
LLB239, LLB233
Plus Assorted Blade Fuses

Part No.	Price
740 051	£4.72

HIGH CURRENT CONNECTORS



High current connectors
Polycarbonate housing
with silver plated solid
copper terminals

Part No.	Capacity	Colour	Price
043 105	50 Amp	Grey	£4.60
043 175	175 Amp	Grey	£8.98
043 135	350 Amp	Grey	£21.30
043 205	50 Amp	Red	£7.12
043 275	175 Amp	Red	£10.72
043 235	350 Amp	Red	£21.30

Auto Electrics

TOGGLE SWITCH



2 Terminal Toggle Switch
12 Volt 20 Amp
6.3mm Terminals

Part No.	Price
295 201	£0.95

12V RELAY - 4 PIN



Rated 30A at 12V DC
With Fixing Bracket &
4 x 6.3mm Blade
Terminals

Part No.	Price
072 712	£4.33

ILLUMINATED ROCKER SWITCH



3 Terminal Illuminated Rocker
Switch
12 Volt 20 Amp
6.3mm Terminals

Part No.	Price
295 203	£1.30

12V RELAY - 5 PIN



Rated 2 x 20A at
12V DC
With Fixing Bracket &
5 x 6.3mm Blade
Terminals

Part No.	Price
072 722	£9.88

ILLUMINATED TOGGLE SWITCH



3 Terminal Illuminated Toggle
Switch
12 Volt 20 Amp
6.3mm Terminals

Part No.	Price
295 202	£1.20

12V FLASHER UNIT



Rated 2-4 x 21+5W at 12V DC
Electronic unit replacing "can
style" hot wire type
No earth, with fixing bracket
3 Terminal

Part No.	Price
060 600	£14.88

12/48V REVERSING ALARM



12-48v, 97Db(A) at 1200Hz
60 Pulses per minute
Polarity protected solid state
epoxy-potted electronics
Steam cleanable

Part No.	Price
056 400	£25.67

12V WARNING BUZZER



12v Dashboard Buzzer
2 Tone - Volume 72dB(A)
Single hole fixing
Two terminal

Part No.	Price
056 262	£17.58

3 POSITION ROTARY SWITCH



Three Position On/Off/On Rotary
Switch
Illuminated (Green) Lever
Rated at 6 Amp (12V)
27mm Panel Hole
Screw Terminals

Part No.	Price
301 006	NLA

ON/OFF TOGGLE SWITCH 12V



On/Off, Single Pole Switch with
rubber sealing gaiter over a
nickel plated brass lever
6.3mm terminals, 13mm panel
hole
10 Amps at 28 volt DC rating

Part No.	Price
060 350	£8.62

Auto Electrics

REVERSING ALARMS



12v/24v Reversing Alarms

Part No.	Voltage	Db	Price
790 501	12v	80Db	£11.20
790 502	24v	80Db	£12.57
790 505	12/24v	95Db	£36.01
089 799	12/24v White Noise	87Db	£41.17

TWIN TERMINAL HORNS



Twin Terminal 'Hi-Note' Horns

Part No.	Description	Price
200 088	12v Horn	£10.50
200 087	24v horn	£11.50

HORN BUTTON



Waterproof Horn Button

Part No.	Price
200 089	£4.73

8 WAY JUNCTION BOX



RUBBOLITE
Model '108' Junction Box
Natural Rubber Housing

Part No.	Price
705 167	£35.07

CIGARETTE LIGHTER SOCKET



Rated 20A Maximum
For Mounting in a 28mm
Panel Clearance Hole

Part No.	Price
060 101	£6.88

CIGARETTE LIGHTER PLUG



Fits most cigarette lighter sockets with red adaptor in place, or DIN socket with the red adaptor removed

Part No.	Price
060 116	£6.17

12V EXTENSION CABLE



Retractable cable, 2.45 metres working length, with standard cigarette lighter plug & socket

Rated at 5 amps, 12 volts for continuous use

Part No.	Price
060 155	£16.85

12V EXTENSION CABLE



Retractable cable, 2.45 metres working length, with standard cigarette lighter plug only

Rated at 5 amps, 12 volts for continuous use

Part No.	Price
200 092	£15.07

DIN TYPE PLUG



Din Type Plug
Max rating 16 Amps

Part No.	Price
067 600	£3.52

DIN TYPE SOCKET



Din Type Socket
Max rating 16 Amps

Part No.	Price
067 630	£4.75

Flashing Beacons

LED BEACON BARS



12/24 volt LED Beacon Bar
Clear Lens (Amber)
8 Built in Flash Modes
R10, R65, IP65 Certified
310 x 159 x 67mm

Part No.	Type	Price
042 265	Bolt Fixing	£46.30
042 202	Magnetic c/w Cig Lighter Plug	£46.30

LED MINI LIGHT BAR



12/24 volt LED Beacon Bar
Amber Lens
10 Built in Flash Modes
R10, R65, IP65 Certified

Part No.	Type	Price
308 055	Bolt Fixing	£77.08
308 057	Magnetic c/w Cig Lighter Plug	£80.42

LED FORKLIFT SPOTLIGHT



LED Safety Warning Spotlights for
Forklift Truck
2x5W
10-80V

Part No.	Type	Price
042 390	Blue	£19.95
042 397	Red	£23.00

1/2 DOME LENS



Spare 1/2 Dome Lens

Suitable for a wide range of LED
beacons

Can be used to replace a
damaged lens or change the
beacon's colour

Part No.	Type	Price
760 103	Amber	£1.87
761 611	Green	£4.91

TALL DOME LENS



Spare Tall Dome Lens

Suitable for a wide range of LED
beacons

Can be used to replace a damaged
lens or change the beacon's colour

Part No.	Type	Price
760 105	Amber	£4.58
760 104	Green	£3.00

FLASHING LED - SINGLE BOLT



LED Beacon Amber and Green
80 x Super Bright SMD

3 Flash modes:
360° revolving, flash, intermittent
flash
ECE R10 EMC Approved
DC 12-24V
IP56 protection standards

Part No.	Type	Price
308 332	Dual Green/Amber	£32.50

FLASHING LED - SINGLE BOLT



LED Beacon Amber and Green
80 x Super Bright SMD

3 Flash modes:
360° revolving, flash, intermittent
flash
ECE R10 EMC Approved
DC 12-24V
IP56 protection standards

Part No.	Type	Price
308 330	Dual Green/Amber	£32.50

FLASHING LED - SPIGOT



Flashing LED Amber and Green.
80 x Super Bright SMD

3 Flash modes:
360° revolving, flash, intermittent
flash
ECE R10 EMC Approved
DC 12-24V
IP56 protection standards

Part No.	Type	Price
308 331	Dual Green/Amber	£32.50

Flashing Beacons

LED BEACON - FLEXI SPIGOT



40 Ultra Bright LEDs
DIN Spigot Mount Fixing
Head Diam: 150mm

Dual Voltage (12/24v)
Low Power Consumption
EMC approved (R10)
3 Selectable Patterns

BEACON - MAGNETIC & 3 BOLT



360° Rotating LED Beacon with
Magnetic & 3 Bolt Fixing

3 Flash Settings
IP56 Rated

Part No.	Type	Price
308 040	Amber	£21.00
308 041	Green	£21.00

Part No.	Type	Price
308 302	Amber	£21.20
308 021	Green	£21.20

BEACON - SINGLE BOLT FIXING



360° Rotating Beacon with
Single Bolt Fixing

3 Flash Settings
IP56 Rated
LED Light
12/24v

LED BEACON 1/2 LENS



LED Flashing Beacon
(1/2 Lens)

Magnetic & 3 Bolt Mount
120 flashes per minute
Dual Voltage 12/24v
EMC approved R10 & R65
IP56 Rated

Part No.	Type	Price
308 300	Amber	£19.95
308 301	Green	£19.95

Part No.	Type	Price
308 310	Amber	£21.25
308 042	Green	£26.00

LED BEACON - SINGLE BOLT



40 Ultra Bright LEDs
Single Bolt Fixing
Head Diam: 150mm

Dual Voltage (12/24v)
Low Power Consumption
EMC approved (R10)
3 Selectable Patterns

LED BEACON - 3 BOLT



40 Ultra Bright LEDs
3 Bolt Fixing
Head Diam: 150mm

Dual Voltage (12/24v)
Low Power Consumption
EMC approved (R10)
3 Selectable Patterns

Part No.	Type	Price
308 060	Amber	£23.13
308 061	Green	£23.13

Part No.	Type	Price
308 050	Amber	£23.13
308 051	Green	£26.46

All DIN Spigots suit 12V or 24V Beacons

Bolt on DIN Spigot Beacon Mount c/w Rubber Casp	Weld on DIN Spigot Beacon Mount c/w Rubber Casp	Side Fixing DIN Spigot Mount c/w Rubber Casp	Twin Bolt on DIN Spigot Mount c/w Rubber Casp	Twin Bolt on DIN Spigot Mount with Folding Bracket	Replacement Insert for DIN Spigot Mounts
760 220	760 210	760 230	760 240	760 260	760 250
£6.80	£7.60	£6.60	£6.40	£8.15	£3.60

Flashing Beacons

BEACON - FLEXI POLE MOUNT



LED Light
Flexible Pole Mount
ECE R65 Road Legal
120 Flashes Per Minute
IP56, R10 Rated

Part No.	Type	Price
308 306	Amber	£23.80
308 307	Green	£22.80

MICRO BEACON - FLEXI SPIGOT



LED Flashing Beacon
Flexi DIN Spigot Fixing
36 High-Intensity LEDs
EMC approved R10, R65
IP66 Rated
SAE J845 Compliant

Part No.	Type	Price
308 309	Amber	£27.00
308 001	Green	£25.92

LED BEACON LOW PROFILE



Flashing Beacon
Magnetic & 3 Bolt Fixing
120 Flashes Per Minute
Dual Voltage 12/24v
EMC approved R10 & R65
IP56 Rated

Part No.	Type	Price
308 312	Amber	£21.25
308 365	Green	£21.25

LED BEACON - 3 BOLT FIXING



Purple Flashing Beacon 1/2 Lens
40x Ultra Bright LED Light
3 Bolt Fixing
Dual Voltage 12/24v
3 Selectable Patterns
EMC approved R10
IP66 Rated

Part No.	Voltage	Price
308 052	12/24v	£24.50

MICRO BEACON - MAGNETIC



Amber Flashing Micro Beacon
Magnetic & 3 Bolt Fixing
36 High-Intensity LEDs
Comes With Cigarette Lighter Plug
EMC approved R10 & R65
IP66 Rated

Part No.	Voltage	Price
308 002	12-24v	£26.61

RECHARGEABLE LED BEACON



Amber Flashing Beacon
Magnetic Fixing
36 High-Intensity LEDs
8 Hour Operational Time
Charges via DC12-24V Plug
EMC approved R10 & R65
IP56 Rated

Part No.	Type	Price
308 400	Amber	£42.06

LED BEACON - FLEXI SPIGOT



Purple Flashing Beacon 1/2 Lens
DIN Spigot Mount Fixing
Dual Voltage 12/24v
3 Selectable Patterns
EMC approved R10 & R65
IP67 Rated

Part No.	Voltage	Price
803 534	12-24v	£24.17

LED BEACON - SINGLE BOLT



Purple Flashing Beacon 1/2 Lens
40x Ultra Bright LED Light
Dual Voltage 12/24v
Operating from -30°C to +50°C
EMC Approved R10
IP66 Rated

Part No.	Voltage	Price
308 062	12/24v	£24.17

LED BEACON - MAGNETIC



Purple Flashing Beacon 1/2 Lens
40x Ultra Bright LED Light
3 Bolt Fixing
Dual Voltage 12/24v
3 Selectable Patterns
EMC approved R10
IP66 Rated

Part No.	Voltage	Price
308 043	12/24v	£21.53

Auto Gauges

CIGARETTE LIGHTER ADAPTOR



Cigar Lighter Double Adaptor
This handy adaptor plugs into a single 12V cigarette lighter socket to give 2 outputs. Ideal if you need to connect multiple devices such as sat navs, phone kits, chargers etc

Part No.	Price
060 190	£9.83

CROCODILE CLIPS









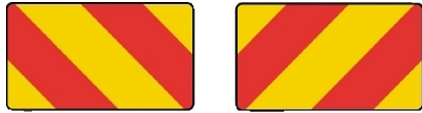

Zinc Plated Crocodile Clips

Part No.	Description	Price
255 218	5 Amp (1 red, 1 black)	£0.72
255 219	25 Amp	£0.60
255 220	50 Amp	£0.70

12V Battery Condition Voltmeter 90 Degree Sweep 52mm diameter Scale 8V to 16V	30-0-30 Amp Ammeter 90 degree sweep 52mm diameter c/w 12/24V illumination bulbs	12V Oil Pressure Gauge 90 degree sweep c/w 1/8" NPTF sender 52mm diameter	10V - 86V Engine Hour Counter 52mm diameter 75mm deep Non illuminated
052 322 £35.73	052 301 £32.37	052 316 £42.77	052 308 £50.52
12V illuminated Fuel Gauge c/w Adjustable Sender 52mm diameter	12V Water Temperature Gauge 90 degree sweep c/w 1/8" NPTF sender 52mm diameter	12V Oil Temperature Gauge 90 degree sweep c/w 1/8" NPTF sender 52mm diameter	12/24V Air Pressure Gauge c/w 1/8" NPTF Union & 12" Copper Capillary c/w 24V and 12V bulbs
052 306 £57.72	052 323 £49.38	052 315 £49.38	053 301 £42.63

Marker Boards

		
UK Marker Board (Type 1) 1400 x 140mm Trucks up to Apr 1996 Trailers up to Oct 1995	UK Marker Board (Type 2/3) 700 x 140mm Trucks up to Apr 1996 Trailers up to Oct 1995	UK/EU Marker Board (EC70) 1130 x 130mm Trucks after Apr 1996 Trailers after Oct 1995
705 130 £15.65	705 131 (pair) £13.38	705 209 £20.23
		
Short Chevron 420 x 235mm Trucks up to Apr 1996 Trailers up to Oct 1995	UK/EU Marker Board (EC70) 283 x 140mm Trucks after Apr 1996 Trailers after Oct 1995	UK/EU Marker Board (EC70) 565 x 130mm Trucks after Apr 1996 Trailers after Oct 1995
705 133 (pair) £16.23	705 213 (set of 4) £21.08	705 212 (pair) £22.27
		
UK/EU Marker Board (EC70) 565 x 200mm Trucks after Apr 1996 Trailers after Oct 1995	UK/EU Marker Board (EC70) 283 x 200mm Trucks after Apr 1996 Trailers after Oct 1995	Metal Holder for 300 x 400mm Hazard Warning Plates
705 211 (pair) £27.62	705 214 (set of 4) £25.92	200 518 £17.00

DRIVER & PPE ADR KIT



A driver & PPE ADR kit.
Kit contains the following:
Kit Bag, ABEK filters, Anti-static shovel, ATEX safety torch, Chemical suit (XL), Hi-visibility vest, Protective gloves, Safety goggles, Respirator, Safety wellington boots, Waste bags and ties x 2, Eyewash x 2 (500ml), First aid kit, Warning triangle x 2, Microlite x 2, Neoprene drain cover

FOLDING HAZARD PLATE



Folding Hazard Warning Vehicle Plate - Folds when the vehicle is empty

Part No.

ADR

Price

£314.70

Part No.

200 520

Price

£39.98

License Holders & Height Indicators

LOAD PROJECTION MARKERS



Load Projection Markers
Pre drilled for attaching to load
Facility to mount number plate
lamp.
610 x 610mm

Part No.	Description	Price
200 158	Aluminium	£23.99
200 159	PVC	£24.49

VEHICLE HEIGHT INDICATOR



In Cab Adjustable Height Indicator
Durable plastic construction
Easy to operate

Part No.	Price
780 040	£13.40

REFLECTIVE TAPE - RED



Reflective Tape
50mm Wide High Visibility Tape
12.5 Metre Length
Honeycomb Pattern

Part No.	Description	Price
820 501	Red Honeycomb Tape	£34.50

MOT HOLDER



Lightweight MOT Plate Holder
(for In Cab Use)
Rustproof Nylon (Plastic) with
Clear Plastic Window
(Suitable for VTG6A)

Part No.	Price
780 010	£6.52

REFLECTIVE TAPE - YELLOW



Reflective Tape
50mm Wide High Visibility Tape
12.5 Metre Length
Honeycomb Pattern

Part No.	Description	Price
820 550	Yellow Honeycomb Tape	£35.95

SINGLE LICENSE HOLDER



Single Licence Disc Holders
Screw/Bolt On Type
Zinc Plated Steel Back & Stem

Part No.	Price
780 001	£2.25

REFLECTIVE TAPE - WHITE



Reflective Tape
50mm Wide High Visibility Tape
12.5 Metre Length
Honeycomb Pattern

Part No.	Description	Price
820 503	White Honeycomb Tape	£35.60

TWIN LICENSE HOLDER



Twin Licence Disc Holders
Screw/Bolt On Type
Zinc Plated Steel Back & Stem

Part No.	Price
780 002	£11.78

Self Adhesive Hazard Warning Diamonds



Part No.	Size	Price	Part No.	Size	Price	Part No.	Size	Price	Part No.	Size	Price
299 001	100x100	£1.15	299 011	100x100	£1.15	299 021	100x100	£1.15	299 031	100x100	£1.15
299 002	200x200	£3.85	299 012	200x200	£3.85	299 022	200x200	£4.24	299 032	200x200	£4.22
299 003	300x300	£7.90	299 013	300x300	£8.71	299 023	300x300	£7.90	299 033	300x300	£8.71



Part No.	Size	Price	Part No.	Size	Price	Part No.	Size	Price	Part No.	Size	Price
299 051	100x100	£1.15	299 061	100x100	£1.15	299 081	100x100	£1.15	299 091	100x100	£1.15
299 052	200x200	£3.85	299 062	200x200	£3.85	299 082	200x200	£3.85	299 092	200x200	£3.85
299 053	300x300	£8.71	299 063	300x300	£7.90	299 083	300x300	£8.71	299 093	300x300	£8.71



Part No.	Size	Price	Part No.	Size	Price	Part No.	Size	Price	Part No.	Size	Price
299 111	100x100	£1.15	299 121	100x100	£1.15	299 131	100x100	£1.15	299 141	100x100	£1.15
299 112	200x200	£3.85	299 122	200x200	£3.85	299 132	200x200	£4.24	299 142	200x200	£3.85
299 113	300x300	£7.90	299 123	300x300	£7.90	299 133	300x300	£7.90	299 143	300x300	£7.90

MOTORWAY MAINTENANCE

MOTORWAY MAINTENANCE

100mm x 900mm

HIGHWAY MAINTENANCE

HIGHWAY MAINTENANCE

100mm x 900mm

Part No.	Description	Price	Part No.	Description	Price
790 517	Self Adhesive Vinyl	£6.50	790 519	Self Adhesive Vinyl	£6.50
790 518	Windowstick	£6.50	790 520	Windowstick	£6.50

Vehicle Mirrors

MIRROR HEAD - 325 X 195MM



Flat Mirror Head

Size: 325 x 195mm
Fixing Arm Dia. 16 - 28mm

Part No.	Description	Price
310 052	Mirror Head	£14.95
310 061	Replacement Glass	£4.65

MIRROR HEAD - 260 X 158MM



Convex Mirror Head

Size: 260mm x 158mm
Fixing Arm Dia. 10 - 20mm
Convex - E No.: e11 II 02*3703

Part No.	Description	Price
310 064	Mirror Head	£8.70
700 093	Replacement Glass	£3.55

MIRROR HEAD - 390 X 190MM



Convex Mirror Head

Size: 390mm x 190mm
Fixing Arm Dia. 16 - 28mm
Convex - E No.: e11 III 03*6589

Part No.	Price
310 065	£30.63

MIRROR HEAD - 320 X 275MM



Convex Oval Mirror Head with
Tunnel Mount Fitting Attachment

Size - 320mm x 275mm
Fixing Arm Dia. 19mm



Part No.	Price
310 050	£57.51

MIRROR HEAD - 293 X 210MM



Convex Mirror Head

Size: 293mm x 210mm
Arm Dia. 10 - 20mm
Convex - E No.: e11 VI 03*6447

Part No.	Price
310 075	£64.62

MIRROR HEAD - 183 X 131MM



Convex Mirror Head

Size: 183 x 131mm
Fixing Arm Dia. 10 - 20mm
Convex - E No.: e11 III 02*3704

Part No.	Price
310 070	£4.98

MIRROR HEAD - 210 X 110MM



Mirror Head

Size: 210 x 110mm
Fixing Arm Dia. 10 - 20mm

Part No.	Price
310 062	£23.50

FISH EYE MIRROR



Fish Eye Mirror
330 x 170mm
Fits 18-20mm Tube

Part No.	Price
10241	£33.13

MIRROR HEAD - DIAM 220MM



Convex, Round Mirror Head with
12mm Single Bolt Fixing

Dia. 220mm x 180mm High



Part No.	Price
310 074	£29.95

Vehicle Mirrors

			
Mirror Arm - U Shaped Length - 320mm Bolt on Bracket	Mirror Arm - U Shaped Leyland Lynx Overall Length: 280mm	Mirror Arm - L Shaped Overall Length: 1015mm 750mm to Bend	Mirror Arm - U Shaped Bar Dia. 16mm Overall Length: 375mm
310 198 £15.78	310 186 £12.25	310 051 £29.75	310 663 £15.78
			
Mirror Arm Length - 165mm Bolt Hole Centres - 55mm Fits Kubota Diggers	Mirror Arm - L Shaped Bar Dia. 12mm Overall Length: 140mm	Mirror Arm - S Shaped Bar Dia. 16mm Overall Length: 360mm	Mirror Arm - L Shaped Bar Dia. 16mm Overall Length: 400mm
310 360 £9.50	705 017 £29.89	310 049 £13.50	310 047 £13.50
			
Mirror Arm Bracket for Block Type Fitting	Mirror Arm Bracket Suitable for Mirror Arms with a 18-20mm Tube	Self Adhesive Double Sided Mirror Pads 40x25mm Pack of 50	Loctite Rear View Mirror Bonder 0.5ml Bonds Metal & Glass
310 048 £6.95	310 671 £18.50	705 098 £4.50	865 658 £5.17

REAR/FRONT CAMERA KITS 7"

Digital Colour TFT LCD Monitor, Mirror and Normal, Switch Available, Runs on 12 Volts or 24 Volts (10-32V)
Full-Function Remote Control, High Resolution Camera

Fig. 1



Fig. 2



Part No.	Fig.	Description	Price
308 600	1	Rear View Camera Kit	£128.00
308 700	2	Rear/Front Camera & Sensor Kit	£251.30

Windscreen Accessories

STANDARD WIPER BLADES



Robust Full Metal Frame and Even Blade Pressure Ensures Excellent Performance, with a Pre-Mounted Quick Clip Universal Adaptor

Part No.	Size	Price
117 012	11"	£2.40
117 013	12"	£2.62
117 014	13"	£2.62
117 015	14"	£2.80
117 001	15"	£2.80
117 002	16"	£2.80
117 003	17"	£3.00
117 004	18"	£3.00
117 005	19"	£3.60
117 006	20"	£3.60
117 007	21"	£4.00
117 008	22"	£4.00
117 009	24"	£4.40
117 010	26"	£4.60
117 011	28"	£5.00

BOSCH WIPER BLADES



Flat Plant Windscreen Wipers Suitable for Cranes, Diggers and Forklifts



Part No.	Size	Price
960 190	16"	£3.60
960 191	18"	£3.90
960 192	20"	£4.75
960 193	22"	£9.45
960 194	24"	£9.26
960 195	28"	£12.30

COMMERCIAL VEHICLE BLADES



Windscreen Wipers Suitable for Commercial Vehicles, Includes Relevant Attachments for Fittings

Additional Attachments May Not Be Required for Every Application

Part No.	Size	Attachment / Type	Price
117 027	20"	Hook Adaptor	£3.90
117 028	20"	Saddle Nut & Bolt	£5.30
117 029	22"	Saddle Nut & Bolt	£5.45
117 030	22"	Hook Adaptor	£3.90
117 031	22"	Hook & Short Hook	£5.95
117 032	22"	Hook & Nozzle(Washer Wiper)	£5.60
117 033	24"	Saddle Nut & Bolt	£6.87
117 034	24"	Hook & Short Hook	£6.17
117 035	24"	Hook & Nozzle(Washer Wiper)	£6.15
116 170	26"	Saddle Nut & Bolt	£8.58
117 037	26"	Hook & Short Hook	£6.75
117 038	26"	Hook & Nozzle(Washer Wiper)	£5.80
117 039	28"	Hook & Short Hook	£7.20
117 040	28"	Hook & Nozzle(Washer Wiper)	£6.71
117 041	28"	Saddle Nut & Bolt	£7.38
116 140	32"	Saddle Nut & Bolt	£11.21
116 140	32"	Spacers for Saddle Fitting	£11.21
117 044	36"	Spacers for Saddle Fitting	£14.40
117 045	36"	Reverse Hook	£14.35
117 046	38"	Spacers for Saddle Fitting	£16.10
117 047	38"	Reverse Hook	£18.25

HYBRID WIPER BLADES



Hybrid Windscreen Wipers for Cars and Commercial Vans Includes Hook Adapter Additional Attachments May Not Be Required for Every Application

Part No.	Size	Price
117 017	16"	£3.55
117 018	17"	£3.65
117 019	18"	£3.75
117 020	19"	£3.75
117 021	20"	£3.75
117 022	21"	£3.85
117 023	22"	£3.85
117 024	24"	£4.15
117 025	26"	£4.79
117 026	28"	£4.70

WIPER RUBBER REFILLS



Pairs of Replacement Windscreen Wiper Rubber Refills Suitable for Cars, Vans and Commercial Vehicles

Part No.	Size	Price
117 048	(6.5mm Wide) - Up to 24"	£2.59
117 049	(8.5mm Wide) - Up to 24"	£2.10
117 051	(6.5mm Wide) - Up to 28"	£2.90
117 052	(8.5mm Wide) - Up to 28"	£2.90

PLANT FLAT WIPER BLADES



Flat Plant Windscreen Wipers Suitable for Cranes, Diggers and Forklifts

Part No.	Size	Price
117 092	10"	£6.73
117 093	12"	£6.73
117 094	14"	£7.09
117 095	16"	£7.75
117 096	18"	£7.35
117 097	20"	£18.23

Windscreen Accessories

10M WASHER JET TUBING



10 Metre Roll of Replacement Black Tubing for Windscreen Washer Jets

Part No.	Price
117 170	£9.25

CLEAR PVC TUBING



Clear PVC Tubing Suitable for Windscreen Washers

30m Rolls

Part No.	Internal Dia.	Price
775 111	3mm	£11.17
775 113	4mm	£12.27
775 112	5mm	£12.27
775 108	6mm	£15.40

WINDSCREEN WASHER PUMPS



Fig1.



Fig2.

Universal Windscreen Washer Pumps for Cars, Vans and Commercial Vehicles

Part No.	Type	Fig	Price
775 181	12 Volt	1	£10.22
775 191	24 Volt	1	£10.04
117 168	12 Volt	2	£10.97
117 169	24 Volt	2	£12.66

NON RETURN FOOTVALVE



Non Return Foot Valve Fits 5mm (3/16") i.d. Tubing

Part No.	Price
775 132	£3.57

NON RETURN VALVE



Non Return In-Line Valve Fits 5mm (3/16") i.d. Tubing

Part No.	Price
775 142	£1.81

WATER BOTTLES



Universal Replacement Water Bottles for Cars, Vans and Commercial Vehicles

Part No.	Voltage	Price
117 167	1.25 Litre	£21.95
117 166	2.2 Litre	£21.75

WASHER T-PIECE



Windscreen Washer 'T' Piece Fits 5mm (3/16") i.d. Tubing

Part No.	Price
775 122	£0.81

WASHER ELBOW



Windscreen Washer Elbows Fits 5mm (3/16") i.d. Tubing

Part No.	Price
775 125	£2.51

Wiper Blades

Full range of Wiper Blades and Accessories available on our Website.

www.lsengineers.co.uk

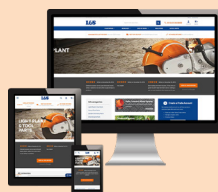

Windscreen Accessories

SINGLE JET OUTLET



Windscreen Washer Single
Outlet Jet
Fits 5mm (3/16") i.d. Tubing

Part No.	Price
775 162	£2.27

WINDSCREEN COVER



Windscreen Frost Protector with
Carry Pouch

Size 1900 x 740mm

Part No.	Price
999 380	NLA

DOUBLE JET OUTLET

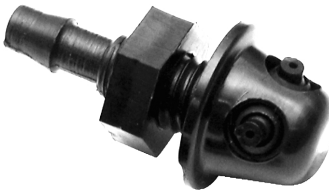

Windscreen Washer Double
Outlet Jet
Fits 5mm (3/16") i.d. Tubing

Part No.	Price
775 172	£2.25

SCRAPER & SQUEEGEE



3 Way Scraper, Rubber Squeegee
Sponge Strip & Ice Scraper

Part No.	Price
999 340	£1.95

SCREEN WASH



Protection down to -20°C
Concentrated High Power
Windscreen Washer Additive
Quickly Removes Dirt, Grime &
Insect Deposits

Part No.	Size	Price
200 782	1 Litre	£2.10
865 417	5 Litre	£5.60

ICE SCRAPER WITH GLOVE



Deluxe Ice Scraper with Insulated
Glove. Grooved Edge for Extreme
Ice Removal
Insulated Glove Keeps hands
Warm & Dry

Part No.	Price
006 965	£4.00

DE-ICER



De-Icer
Melts Ice from Windows, Mirrors
& Locks down to -15°C

Part No.	Size	Price
200 789	600ml Aerosol	£2.68
865 422	500ml Trigger Spray	£2.63

DE-ICER WINTER PACK



De-Icer Trigger Bottle Type
Screen Wash Concentrated 1 Litre
Foam Handled Ice Scraper

Part No.	Price
777 099	£6.90

Vehicle Washdown Equipment

VEHICLE WASH BRUSH



Vehicle Wash Brush
Rubber construction, soft
nylon bristles c/w hand piece
for hosing down

Suitable for 1/2" Bore Hose

Part No.	Price
895 358	£34.72

POLISHING CLOTH



Polishing Cloth on Roll

800g Stockinette Roll
7m length

Part No.	Price
110 121	£7.30

JUMBO SPONGE



Jumbo Cleaning Sponge
Suitable for Vehicle, Decorating
& General Cleaning

Part No.	Price
200 786	£1.46

3FT WASH BRUSH HANDLE



Vehicle Wash Brush Handle
Additional pieces can be
screwed together to make a
longer handle

Use with 895 358

Part No.	Price
895 359	£15.80

CHAMOIS LEATHERS

Chamois Leathers



Part No.	Size	Price
895 355	Leather - Large	£10.82
895 356	Synthetic	£3.89

EXTENDING WASH BRUSH



3ft Extendable wash brush with
rubber head and long life soft
nylon bristles

Suitable for 1/2" Bore Hose
Extends 3ft to 6ft

Part No.	Price
895 350	£19.55

WHITE COTTON RAGS



'Rags-In-A-Bag'
White Cotton/Polyester
for Wiping & Polishing

Part No.	Price
200 908	£23.50

STP COCKPIT SPRAY



STP 'Son Of A Gun!'
250ml Pump Bottle
Restores The Lustre and Shine of
Vinyl, Leather, Rubber, PVC, Wood
and Plastic. Helps Protect Against
The Effects of Weathering

Part No.	Price
865 518	£5.60

PLASTIC BUCKET



With Handle & Pouring Lip,
Heavy Duty Polythene
14 Litres Capacity

Part No.	Price
902 2242	£2.90

Tacho Equipment

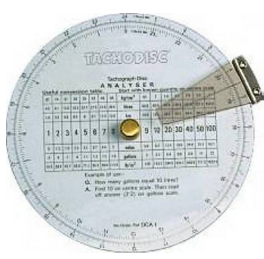
				
Digital Tachograph Card Reader Requires Windows PC	TachoDisc Digital Printer Rolls	TachoDisc Vehicle Check and Defect Book	TachoDisc Vehicle Defect Report Pad	Tachodisc Weekly Envelopes
TACHO READER £58.30	DPR (box of 3) £7.17	T20 £2.95	CVDR £6.45	TE £9.44
				
TachoDisc T1/T2 125 kph (Pear Shaped Hole)	TachoDisc T3 CS901D 125 kph Smiths Manual/Auto	TachoDisc T4 CV701 120 kph Veeder Manual	TachoDisc T8 CV712 120 kph Veeder Automatic	TachoDisc T2/180 180 kph Kensie (Transits)
T1/T2 (per 100) £9.70	T3 (per 100) £21.25	T4 (per 100) £9.50	T8 (per 100) £12.50	T2/180 (per 100) £5.51
				
TachoDisc Disc Analysis Tool	TachoDisc Driver's Wallet (Hardback)	Drivers Digital Tachograph Organiser Wallet	TachoDisc Tachograph Log Book for Drivers in Road Transport	Tachodisc Vehicle Maintenance Wallchart
DCA1 £43.49	THW £5.80	TDOW £13.75	TS15 £4.29	VMC £9.44
				
TachoDisc Suspended Files Stores Discs in 12 pockets	TachoDisc Filling Cabinet Wallets	TachoDisc Drivers Hour Guide	TachoDisc Tachograph A5 Operating Handbook	Tachodisc Vehicle Maintenance Record 24 Page Book
CSF (Pack of 5) £72.19	TFW £6.05	TDH £3.70	OH2 £7.90	VMR £7.70

Exhaust Accessories



Heavy Duty Flexible Exhaust Pipe

Heavyweight Zinc Plated Polygonal Exhaust Flex. Sold Per Metre

Part No.	Internal Dia.	Price	Part No.	Internal Dia.	Price
94025	1"	£12.25	94048	1.7/8"	£22.85
94032	1.1/4"	£14.28	94050	2"	£24.35
94035	1.3/8"	£14.12	94075	3"	£47.53
94038	1.1/2"	£18.68	94010	4"	£68.57
94044	1.3/4"	£20.68	94125	5"	£89.07
			94252	6"	£98.10

EXHAUST TAPE



Heat Resistant Exhaust Tape
50mm x 3mm x 30 metres

Glass fibre webbing tape resistant
to oils, most chemicals and solvents
Suitable for temps up to 550°C

Part No.	Price
300 390	£44.85

EXHAUST BOBBIN



Mini Exhaust Bobbin
Universal Fitting

Part No.	Price
405 101	£1.43

EXHAUST CLAMPS



Zinc Plated

Part No.	Size	Price (each)
405 102	35mm (1.3/8")	£0.50
405 103	38mm (1.1/2")	£0.66
405 104	41mm (1.5/8")	£0.62
405 106	45mm (1.3/4")	£0.64
405 107	48mm (1.7/8")	£0.60
405 108	51mm (2")	£0.60
405 109	54mm (2.1/8")	£0.60
405 110	57mm (2.1/4")	£0.78
405 111	64mm (2.1/2")	£0.91
405 112	67mm (2.5/8")	£0.90
405 113	79mm (3.1/8")	£1.39
405 119	92mm (3.5/8")	£1.30
513 919	102mm (4")	£2.70
513 920	115mm (4.1/2")	£3.10
110 118	Assorted Pack of 25	£13.10

EXHAUST MOUNTING RINGS



Exhaust Mounting Rings
Black Rubber

Part No.	Size	Price (each)
405 133	Medium	£1.56
405 134	Large	£1.91

EXHAUST PASTE



FIXT Exhaust Assembly Paste

Part No.	Description	Price (each)
FX085501	Exhaust Paste 300g	£6.40
865 246	Caulking Gun	£4.50

HYLOMAR EXHAUST PUTTY



Repairs Leaks and Small Holes in
Exhaust, Pipes, Silencers &
Expansion Boxes
Withstands 1000(deg)C

Part No.	Size	Price (each)
865 129	140g Tube	NLA
865 676	250g Tub	£2.78

ASS. MANIFOLD NUTS/STUDS



Assorted Box of Manifold Studs
& Nuts

Various Metric & Imperial Sizes

Part No.	Price
105 217	£25.08

Brake Nuts & Tubing

CUPRO-NICKEL BRAKE TUBE

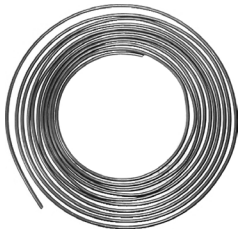

Seamless 90/10 Cupro-Nickel

COPPER PIPING



22 Gauge

Part No.	O/D	Length	Price
605 116	3/16"	25ft	£15.15
605 117	1/4"	25ft	£28.17
605 119	3/8"	25ft	£34.20

Part No.	O/D	Length	Price
305 201	6mm	25ft	£33.69
305 202	8mm	25ft	£40.51
305 203	10mm	25ft	£51.08
305 103	3/16"	25ft	£17.58
305 104	1/4"	25ft	£34.16
305 105	5/16"	25ft	£44.21
305 106	3/8"	25ft	£50.26
305 107	1/2"	25ft	£60.38

FLARING TOOL

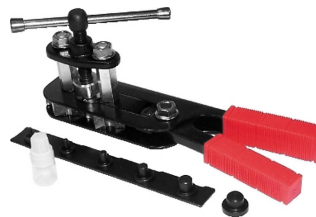

One Piece Construction Adapts to all Pipe Sizes Without the Need to Dismantle

Part No.	Price
305 140	£57.75

Male Brake Tube Nut Size: 3/8 x 24 tpi Suits 3/16" Pipe	Female Brake Nuts Size: 3/8 x 24 tpi Suits 3/16" Pipe	Male Brake Tube Nut Size: 10mm x 1mm Pitch Suits 3/16" Pipe	Female Brake Nut Size: 10mm x 1mm Pitch Suits 3/16" Pipe	Male Brake Nut Size: 7/16" X 20tpi Suits 1/4" Pipe		
305 108 £0.20	305 109 £0.30	305 110 £0.25	305 111 £0.20	305 112 £0.30		
Female Brake Nut Size: 7/16" x 20tpi Suits 1/4" Pipe	Long Male Brake Nut Size: 10mm x 1.25mm Suits 3/16" Pipe	Short Male Brake Nut Size: 10mm x 1.25mm Suits 3/16" Pipe	Long Male Brake Nuts Size: 10mm x 1mm Pitch Suits 3/16" Pipe	Male Brake Nut Size: 10mm x 1mm Pitch Suits 3/16" Pipe		
305 113 £0.74	305 120 £0.30	305 121 £0.30	305 122 £0.25	305 123 £0.20		
Short Male Brake Nut Size: 3/8" X 24 tpi Suits 3/16" Pipe	Male Brake Nut Size: 10mm X 1.25mm Suits 3/16" Pipe	Male Brake Nut Size: 12mm X 1mm Suits 3/16" Pipe	Part No.	Type	Pipe O/D	Price
305 141 £0.30	305 142 £0.30	305 143 £0.40	305 146	10mm Male 2-Way	3/16"	£0.70
			305 147	10mm Fem 2-Way	3/16"	£1.00
			305 148	10mm Fem 3-Way	3/16"	£9.13
			305 149	3/8" Fem 2-Way	3/16"	£1.00
			305 150	3/8" Fem 3-Way	3/16"	£7.60

Vehicle Miscellaneous

SINGLE NYLON SEAT COVER



Single Nylon Seat Cover
Universal, Waterproof

Part No.	Price
TR650	£11.30

ROCK SALT - 25KG



Brown Rock Salt - 25kg Bag
Ideal for Clearing Paths, Drive Ways & Car Parks

Part No.	Price
999 010	£9.10

ROCK SALT - 40 X 25KG BAGS



Brown Rock Salt - 40 x 25kg Bags
Ideal for Clearing Paths, Drive Ways & Car Parks

Part No.	Price
999 026	£311.50

VAN SEAT COVER SET



Single & Double Nylon Seat Cover Set
Universal, Waterproof

Part No.	Price
TR652	£21.00

ROCK SALT - 1 TONNE BAG



Brown Rock Salt Loose in a Tonne Bag - Weight 1000kgs
All our de-icing salt fully complies with the BS3247 British Standard for de-icing salt.

Part No.	Price
999 027	£258.00

SEAT COVER DISPENSER



Box of 100 Disposable Heavy Duty Car Seat Covers
In a Dispenser Box

Part No.	Price
895 056	£25.25

BROWN PAPER FLOOR MATS



Pack of 500 Disposable Paper Floor Mats

Part No.	Price
895 178	£29.68

WALK BEHIND SALT SPREADER



Walk Behind Salt Spreader
Capacity (Weight): 27kg
Capacity (Volume): 16ltr
Spread: 3-3.6mtr

Sprays in 360° Motion to Cover a Large Area

Part No.	Price
999 017	£124.30

WARNING TRIANGLE WT1



To European Standard ECE R27 and tested to E1 Specifications

Part No.	Price
971 425	£5.55

SNOW SHOVEL



Plastic Scoop with wooden handle. Ideal for cleaning drive ways and paths.
Scoop width: 420mm

Part No.	Price
999 329	£17.98

Vehicle Miscellaneous

RADIATOR HOSE



Reinforced, Heat Resistant Flexible Rubber Radiator Hose

Made from EPMD Rubber
150 PSI/10 Bar Working Pressure
-40° - 120°C Temp Range

Supplied in 1 Metre Lengths

Part No.	Inner Diameter/Outer Diameter	Price
010 028	I/D 28mm/ O/D 36mm	£15.49
010 032	I/D 32mm/ O/D 41mm	£17.33
010 035	I/D 35mm/ O/D 45mm	£14.83
010 038	I/D 38mm/ O/D 47mm	£13.54
010 045	I/D 45mm/ O/D 55mm	£25.38
010 051	I/D 51mm/ O/D 61mm	£30.67

BODY FILLER



Super Smooth Multi-Purpose Body Filler
Tough, Easy to Sand Finish
For Wood, Steel, GRP, Aluminium, Stone & Plastic

Sets in 20 Minutes (at 18°C)

Part No.	Size	Price
001 250	250ml	£5.74
001 600	600ml	£12.40
001 200	2 Litre	£26.77

CE-LIT RADIATOR CEMENT



CE-LIT Radiator Cement
Cures Leaky Radiators, Cylinder Blocks & Water Pumps
Even when used with Anti-Freeze

24 Sachets

Part No.	Price
865 149	£24.15

FIBRE GLASS REPAIR KIT

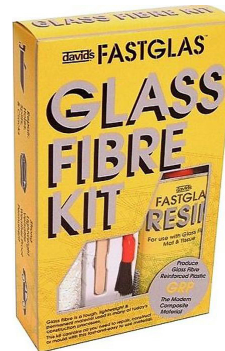

Tough, Lightweight, Permanent Repair
Contains 250ml 'Grade A' Resin Hardener 170sq metres - 450g Glass Fibre Mat, Spatula, Mixing Cup, Brush & Full instructions

Part No.	Price
200 781	£15.70

ROUND FUNNEL KIT



Set of 4 Round Funnels
50, 75, 100, 120mm Diam

Part No.	Price
895 065	£2.45

UNIVERSAL GAITER KIT



Universal Gaiter Kit

Complete with Stretch Boot, Clips & Grease

Part No.	Narrow End Ø	Wide End Ø	Price
808 909	20mm	90mm	£14.58
808 912	25mm	115mm	£16.33

Water Pump Spares

HONDA WB SERIES WATER PUMP SPARES

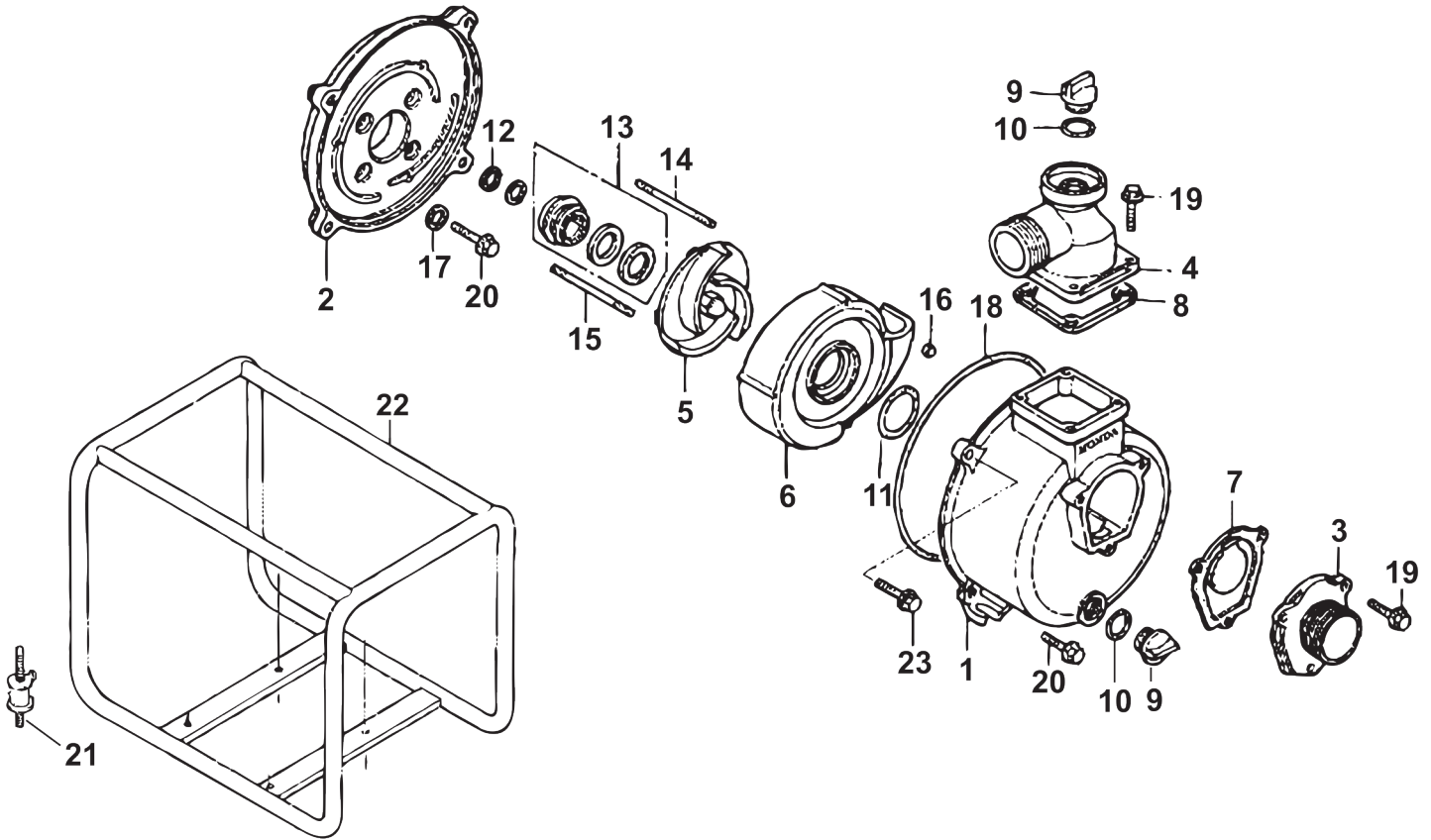

Honda WB20XT (2")			
Part No.	Fig.	Description	Price
78101 YG3 000	1	Pump Housing	£274.48
78102 YG3 000	2	Mounting Flange	£174.70
78103 YG3 000	3	Suction Flange	£82.56
78104 YG3 000	4	Delivery Flange	£36.85
78106 YB3 000	5	Impeller	£158.00
78107 YB3 K10	6	Volute Casing	£219.50
78110 YB3 000	7	Inlet Valve	£40.42
78114 YB3 000	8	Flange Gasket	£12.57
78117 YB3 K10	9	Plug	£19.76
78118 YB0 003	10	Plug Seal	£3.78
78118 YB3 004	11	O Ring	£11.15
78122 YB3 000	12	Shim	£5.47
710 210	13	Mechanical Seal Kit	£11.90
90034 402 000	14	Stud 6x50	£7.78
90043 YB4 000	15	Stud 6x50	£2.70
90281 YB4 000	16	Cap Nut	£1.65
90474 333 000	17	Washer 8mm	£4.59
91351 YB3 003	18	O Ring	£19.87
95701 08025 08	19	Bolt 8x25	£1.69
95701 08028 08	20	Bolt 8x28	£1.69
68311 YB3 K80	21	Rubber Mount	£12.65
50310 YG3 000	22	Pump Frame	£97.30
95701 08028 08	23	Bolt 8x28	£1.69

Honda WB30XT (3")			
Part No.	Fig.	Description	Price
78101 YG4 000	1	Pump Housing	£638.00
78102 YG4 000	2	Mounting Flange	£174.70
78103 YG4 000	3	Suction Flange	£82.56
78104 YG4 000	4	Delivery Flange	£36.85
78106 YB4 000	5	Impeller	£166.40
78107 YB4 020	6	Volute Casing	£232.20
78110 YB4 000	7	Inlet Valve	£40.42
78114 YB4 000	8	Flange Gasket	£15.12
78117 YB3 K10	9	Plug	£19.76
78118 YB0 003	10	Plug Seal	£3.78
78118 YB4 004	11	O Ring	£13.81
78122 YB3 000	12	Shim	£5.47
710 210	13	Mechanical Seal Kit	£11.90
90043 YB4 000	14	Stud 6x50	£2.70
90043 YB4 000	15	Stud 6x50	£2.70
90281 YB4 000	16	Cap Nut	£1.65
90474 333 000	17	Washer 8mm	£4.59
78112 954 003	18	O Ring	£20.51
95701 10032 08	19	Bolt 10x32	£2.52
95701 08028 08	20	Bolt 8x28	£1.69
68311 YB3 K80	21	Rubber Mount	£12.65
50310 YG4 010	22	Pump Frame	£101.60
95701 10032 08	23	Bolt 10x32	£2.52

Water Pump Spares

HONDA WX10K1 WATER PUMP SPARES (GX25 ENGINE)

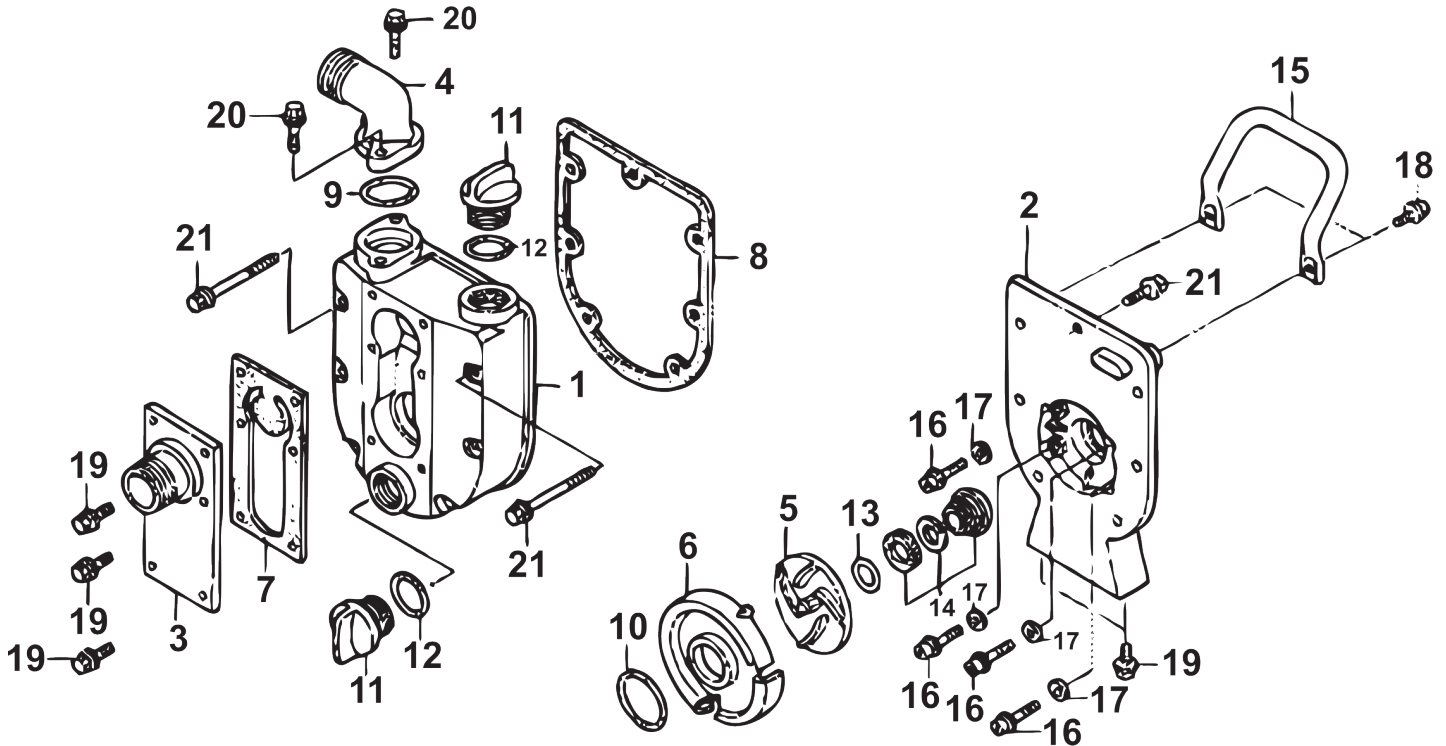

HONDA WX10K1 PUMP

1" Drainage, irrigation and general water transfer pump



Max output (litres/min)	140
Inlet/outlet diameter (mm)	25
Total head (metres)	36
Suction head (metres)	8
Pressure (bars)	3.5
Dry Weight (kg)	6.1
Engine	GX25
Fuel tank capacity (litre)	0.55
Starter	recoil
Length (mm)	325
Width (mm)	220
Height (mm)	300

Part No.	Price
WX10	£392.70

Honda WX10K1 Spares (1")

Part No.	Fig.	Description	Price
78101 YE9 013	1	Pump Housing	£101.40
78102 YE9 506	2	End Plate	£97.50
78103 YE9 003	3	Suction Plate	£37.47
78104 YE9 505	4	Delivery Flange	£27.31
78106 YE9 506	5	Impeller	£36.92
78107 YE9 B01	6	Volute Casing	£47.91
78110 YE9 003	7	Rubber Clack Valve	£13.60
78112 YE9 003	8	End Plate Gasket	£8.61
78114 YE9 505	9	O Ring	£5.23
78115 YE9 505	10	Seal	£6.25
78117 YB7 020	11	Plug	£19.76
78118 YB0 003	12	Seal	£3.78
78122 YH4 610	13	Shim	£4.31
78130 YE9 B01	14	Mechanical Seal Kit	£81.52
78206 YH4 610	15	Handle	£39.14
90110 YE9 B00	16	Socket Cap Screw	£4.02
90452 323 000	17	Washer 5mm	£1.70
95701 06012 00	18	Flange Bolt 6x12	£0.88
95701 06014 00	19	Flange Bolt 6x14	£0.88
95701 06018 00	20	Flange Bolt 6x18	£1.18
95701 06055 00	21	Flange Bolt 6x55	£1.69

Water Pump Spares

2" WATER PUMP SPARES

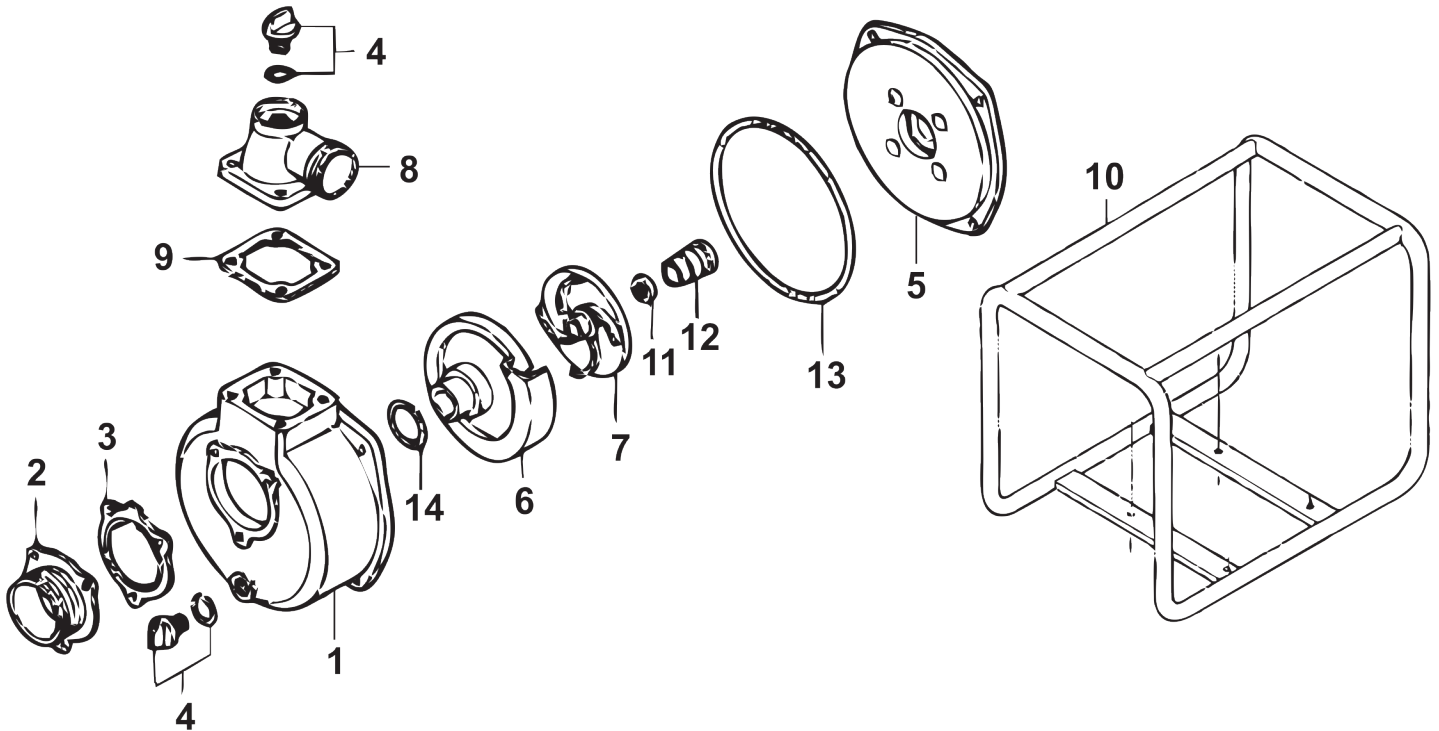

Koshin SEH50X (2")

Part No.	Fig.	Description	Price
011 578	1	Pump Housing	£129.15
011 662	2	Suction Flange	£29.38
011 665	3	Check Valve	£18.55
011 078	4	Plug	£9.39
011 579	5	Mounting Flange	£75.60
011 640	6	Volute Casing	£49.90
011 532	7	Impeller	£56.53
011 628	8	Delivery Flange	£35.78
011 541	9	Flange Gasket	£7.07
200 697	10	Pump Frame	£81.65
011 466	11	Shims	£6.73
011 688	12	Mechanical Seal Kit	£56.53
011 014	13	O Ring Large	£12.01
011 792	14	O Ring Small	£7.90

Koshin SEH50X New Type BEJ (2")

Part No.	Fig.	Description	Price
011 268	5	Mounting Flange	£47.25
011 616	7	Impeller	£39.75
011 090	12	Mechanical Seal Kit	£42.40

All other parts same as SEH50X above

Daishin/Hilta SCR50 (2")

Part No.	Fig.	Description	Price
NLA	1	Pump Housing	-
002 531	2	Suction Flange	£37.91
002 530	3	Check Valve	£21.82
002 529	4	Plug	£5.95
002 521	5	Mounting Flange	£113.70
002 539	6	Volute Casing	£75.65
002 538	7	Impeller	£66.07
002 534	8	Delivery Flange	£53.42
002 535	9	Flange Gasket	£6.90
200 697	10	Pump Frame	£81.65
002 683	11	Shims	£6.59
002 541	12	Mechanical Seal Kit	£40.15
002 522	13	O Ring Large	£11.50
NLA	14	O Ring Small	-

Honda WP20X (2") (older model)

Part No.	Fig.	Description	Price
011 578	1	Pump Housing	£129.15
011 662	2	Suction Flange	£29.38
011 665	3	Check Valve	£18.55
011 078	4	Plug	£9.39
011 579	5	Mounting Flange	£75.60
78107 YE5 003	6	Volute Casing	£79.32
78106 YE5 003	7	Impeller	£72.60
011 628	8	Delivery Flange	£35.78
011 541	9	Flange Gasket	£7.07
200 697	10	Pump Frame	£81.65
011 466	11	Shims	£6.73
710 208	12	Mechanical Seal Kit	£15.25
011 014	13	O Ring Large	£12.01
011 792	14	O Ring Small	£7.90

Water Pumps



1" Water Pump & Hose Kit

Loncin LC25 petrol driven water pump. Featuring an aluminium pump housing, cast iron volute and impeller, high quality ceramic mechanical seal.
Maximum suction: 6m
Maximum Lift: 21m
Maximum Delivery: 8m³/hour

- Kit Includes:
- Loncin 2.5HP Driven 1" Pump
 - 6m Suction Hose
 - 10m Layflat Delivery Hose
 - Suction Filter, Fittings and Clips



Part No.	Price
252 223	£216.90

2" Water Pump & Hose Kit

Loncin LC50 petrol driven water pump. Featuring an aluminium alloy pump housing, cast iron volute and impeller, high quality ceramic mechanical seal.
Maximum suction: 6m
Maximum Lift: 23m
Maximum Delivery: 30m³/hour

- Kit Includes:
- Loncin 5.5HP Driven 1" Pump
 - 6m Suction Hose
 - 10m Layflat Delivery Hose
 - Suction Filter, Fittings and Clips



Part No.	Price
252 224	£273.70





12 Volt Diaphragm Pump Kit

Pumps 17 Litres Per Minute, for Spraying & Transferring Chemicals or Water.
4 Piston Type Pump
Built in Pressure/Demand Switch
Self Priming to 1.8m
EPDM Diaphragm
Temperature Rating 5 - 50





















Part No.	Price
080 670	£96.70

 LONCIN	 LONCIN	 LONCIN
Loncin 1" Water Pump - LC152F Engine - Maximum Suction: 6m - Maximum Lift: 21m - Maximum Delivery: 8,000 ltr/hr	Loncin 2" Water Pump - G160 Engine - Maximum Suction: 6m - Maximum Lift: 23m - Maximum Delivery: 30,000 ltr/hr	Loncin 3" Water Pump - G200 Engine - Maximum Suction: 6m - Maximum Lift: 20m - Maximum Delivery: 48,000 ltr/hr
252 221 £202.30	502 331 £245.80	502 332 £273.60
 HONDA	 HONDA	 HONDA
Honda 1" Water Pump - GX25K1 Engine - Maximum Suction: 8m - Maximum Lift: 36m - Maximum Delivery: 8,400 ltr/hr	Honda 2" Water Pump - GX120 Engine - Maximum Suction: 8m - Maximum Lift: 32m - Maximum Delivery: 36,000 ltr/hr	Honda 3" Water Pump - GX160 Engine - Maximum Suction: 8m - Maximum Lift: 30m - Maximum Delivery: 66,000 ltr/hr
WX10 £392.70	WB20XT £421.90	WB30XT £507.00

Patay Pumps and Accessories

				
Patay DD70C Double Diaphragm Pump Hose Inlet/Outlet: 1" Pumps 70 Litres/min Suitable for Diesel & Oil	Patay DD120C Double Acting Pump Hose Inlet/Outlet: 1.5" Pumps 135 Litres/min Suitable for Diesel & Oil	Patay SD45C Single Acting Pump Hose Inlet/Outlet: 1" Pumps 45 Litres/min Suitable for Diesel & Oil	Patay BE45E Barrel Emptying Hand Pump Hose Inlet/Outlet: 1" Pumps 45 Litres/min For 205 Litre Drums	Patay BE45T Hand Transfer Pump Hose Inlet/Outlet: 1" Pumps 45 Litres/min For Permanent Mounting
DD70C £249.00	DD120C £228.20	SD45C £174.40	BE45E £194.00	BE45T £188.50
				
Patay DD120A Ocean Master Hand Pump Hose Inlet/Outlet: 1.5" Pumps 135 Litres/min Suitable for Diesel	Patay SD60UD Underdeck Bilge Pump Hose Inlet/Outlet: 1"/1.5" Pumps 80 Litres/min Suitable for Diesel & Oil	Patay SD60 Manual Portable Toilet Pump Hose Inlet/Outlet: 1"/1.5" Pumps 66 Litres/min For Prolonged Use	Patay DD100C Double Action Transfer Pump Hose Inlet/Outlet: 1.25" Pumps 100 Litres/min Suitable for Diesel	Patay Garden Hose Hand Pump Hose inlet/Outlet: 1" Pumps 60 Litres/Min Suitable for Hoses
300 653 £362.00	300 654 £86.40	300 655 £102.80	DD100C £258.60	300 657 £134.00
				
Patay DD120B Hand Pump with Handwheels Hose Inlet/Outlet: 1.5" Pumps 135 Litres/min Suitable for Diesel	Patay SD60FM Single Diaphragm Hand Pump Hose Inlet/Outlet: 1" Pumps 66 Litres/min Suitable for Oil & Diesel	24" Stainless Steel Handle with Grip for Patay DD120 Pump Range	12" Stainless Steel Handle with Grip for Patay SD45 Pump Range	15" Stainless Steel Handle with Grip for Patay DD170 Pump Range
300 658 £227.70	300 651 £77.94	S1508 £48.93	S1506 £9.15	S1507 £17.87
				
12" Stainless Steel Handle with Grip for Patay SD60 Pump Range	18" Stainless Steel Handle with Grip for Patay DD120A & DD70FF Pumps	18" Stainless Steel Handle with Grip for Patay DD120AM Pump Range	Strum Box 3/4" Holds Hose Securely at the Bottom of the Bilge Prevents Uptake of Debris	Strum Box 1 - 1.5" With Non-Return Valve Holds Hose Securely Prevents Uptake of Debris
S1506SS £10.57	S1670SS £46.10	S1670M £54.93	B7738 £12.96	B1738 £39.33

Patay Pump Repair/Service Kits & Rocker Arms

				
Repair Kit for Patay DD70 & DD100 Pumps Suitable for Oil & Diesel	Repair Kit for Patay DD120 Ocean Master Pump Range Suitable for Oil & Diesel	Repair Kit for Patay SD45 Pump Range Suitable for Diesel	Repair Kit for Patay SD60 Toilet Pump Not for Diesel	Repair Kit for Patay SD45 Pump Range Not for Diesel
S1975 £36.22	S1974 £65.00	S1997D £24.53	S1851 £14.65	S1997 £33.00
				
Repair Kit (Butyl) for Patay SD45 Pump Range	Repair Kit w/ Aluminium Plate for Patay SD45 Pump Range Suitable for Diesel	Repair Kit (Butyl) for Patay SD60 Pump Range	Repair Kit (Butyl) for Patay BE45E Pump Range	Repair Kit for BE45E Pump Range
S1997B £25.51	S1997D/ALI £24.47	S1851B £38.47	S1002B £25.51	S1002 £33.00
				
Service/Repair for Patay Hand Pumps	Deck Cover & Seal for Patay DD120 Pump Range	Under Deck Bracket for Patay DD120A Pump Range	Bulkhead/Through Deck Seal Kit for Patay Skipper Hand Pump	Through Deck Seal Kit for Patay DD120 & SD60 Pumps
E2261 NLA	B2024 £20.78	B7060 £17.67	B2135 £10.29	B2155 £20.53
				
11.5" Alloy Handle with Grip for Patay BE45 Pump Range	Aluminium Rocker Arm Assembly for Patay DD120 Hand Pumps	Aluminium Rocker Arm Assembly for Patay DD70 Hand Pumps	Rocker Arm Assembly for Patay SD60BM Pumps	Aluminium Rocker Arm Assembly for Patay SD45 Pumps
S1596 £21.77	S1515 £37.75	S1516 £44.15	S1896 £12.42	204 202 £35.39

Patay Pump Accessories

STEPPED HOSE ADAPTORS

Stepped Hose Adaptors are push-on making them simple to fit. They all have a multi-use barbed hose tail, and can be used with 1/2", 3/4", 1" and 1 1/4" Hoses. The Adaptors are made from Polypropylene, making them strong, rigid and durable.



Fig.1



Fig.2



Fig.3



Fig.4

Part No.	Fig	Size	Price
K0984	1	1/2"	£5.17
K0985	2	3/4"	£5.42
K0986	3	1"	£6.08
K0987	4	1 1/4"	£4.93

Conrod Assembly for Patay DD120 Pump Range	Diaphragm Plate for Patay SD45 & DD70 Pump Range	Diaphragm for Patay SD45 & BE45 Pumps Suitable for Diesel	Diaphragm for Patay DD120 Pump Range Suitable for Diesel	Diaphragm Plate (NBR) for Patay DD120 Pumps Suitable for Diesel
S1498 £19.73	S1865 £1.39	PP1906 £13.52	PP1225 £19.89	S1052 £1.79
Mounting Clip for Patay Sump Pump	1 1/4" P Clips (Each) for Patay Sump Pump	Hose and Nozzle Assy for Patay BE45E Hand Pump	Conrod Assembly for Patay DD70 Pump	Base Frame for Patay DD120, DD100 & DD70 Pump Ranges
T7085 £3.00	T7085P £3.40	B2037 £46.13	S1499 £17.13	A2004 £154.80
Suction Tube Assy (400mm) for Patay S7333 Sump Pump	PVC 2 Piece Riser Tube for Patay BE45E Barrel Emptying Hand Pump	Dinghy Bailer Hand Operated Water Pump	Replacement Hand Wheel for Patay DD120 Pump	2" Barrel Bung for Patay BE45E Barrel Emptying Hand Pump
S7333 £9.01	B1222 £18.47	A2074 £55.00	S1391 £4.20	B1196 £10.45

Hand Pumps & Diaphragms

Semi Rotary Hand Pumps



Double acting semi-rotary hand pump. Ideal for dispensing & transferring diesel fuel from small fuel storage containers like bowsers, into plant and machinery.

Part No.	Size	Inlet/Outlet	Transfer Rate	Price
812 050	K0	1/2" BSP	11.50 litres/min	£84.80
812 100	K1	3/4" BSP	17.25 litres/min	£90.00
812 200	K2	1" BSP	22.50 litres/min	£105.00
812 300	K3	1.1/4" BSP	29.00 litres/min	£135.50
812 400	K4	1.1/4" BSP	43.25 litres/min	£112.80

Part No.	Description	Price	Part No.	Description	Price
812 130	Handle & Spike - K0, K1	£8.50	812 145	Wooden Handle Only - K2	£12.87
812 135	Handle & Spike - K2	£16.00	812 147	Wooden Handle Only - K3, K4	£18.05
812 120	Wooden Handle Only - K0, K1	£4.50	124 0001	Gland Packing – 1 Metre Cut	£13.15

Rotary Barrel Pump 1" Outlet 1m Riser Tube	Small Syphon Pump Suitable for Oils & nona- ggressive Chemicals	Large Syphon Pump Suitable for Oils & nona- ggressive Chemicals	Lever Action pump 2" Drum Connection 0.45 Ltr/min	Simplite Diaphragm 220mm Diam x 8mm Hole
J1614 £23.00	200 754 £4.10	200 753 £13.45	635 252 £19.45	836 200 £12.75
Wickham 900 8" Centre Hole 4 Lugs - 16" Lug to Lug	P21 Wickham Oval Clack 165 x 147mm Centre Hole: 18mm	P25 Wickham Square Inlet Clack 114 x 121mm Middle Holes: 12mm	Hilta/Wacker No. 3 Neoprene Diaphragm 13" Diam x 5" Hole	Genie Diaphragm 220mm Diam x 12mm Hole
836 900 £81.49	836 021 £6.80	836 025 £9.80	836 100 £95.40	836 500 £12.10



Ponstar Submersible Pump

Part No.	Description	Price
550 110	110v Centrifugal Pump, 2" Outlet, 290 lts/min, Max Head 10m (no float)	£385.00
030 705	Replacement Power Cable	£27.00
013 393	Replacement Lifting Handle	£16.40
030 706	Float Switch Assy	£16.80
040 650	Chain Stopper	£5.30

Suction & Delivery Hose

Suction Hose



Top selling suction hose for general pumping & suction applications agriculture, industry & construction.

Suitable for water, sludge, slurry, chemicals and other waste matter.

Chemical Resistance: Most oxidising & reducing agents, dilute acids & alkalis.

Part No.	Hose I/D	Length	Price
822 100	1"	6m (20ft)	£14.65
822 130	1"	30m (100ft)	£53.95
822 114	1.1/4"	6m (20ft)	£17.39
822 112	1.1/2"	6m (20ft)	£29.00
822 200	2"	6m (20ft)	£35.00
822 230	2"	30m (100ft)	£126.40
822 300	3"	6m (20ft)	£57.00
822 400	4"	6m (20ft)	£71.85

LAYFLAT DELIVERY HOSE

For open ended delivery of water, chemicals and other liquids.
Not suitable for use with benzene, petrol, spirits, xylol or solvents containing aromatics. Operating Range -15 °C to +55 °C



Blue
Max Pressure 4.5 bar

Hose I/D	10m		50m		100m	
	Part No.	Price	Part No.	Price	Part No.	Price
1"	124 0085	£9.00	124 0086	£36.40	124 0087	£68.33
1.1/4"	124 0088	£14.50	124 0089	£44.00	124 0090	£83.03
1.1/2"	124 0091	£16.80	124 0092	£53.00	124 0093	£79.50
2"	124 0094	£16.54	124 0095	£46.43	124 0096	£78.00
3"	124 0097	£17.42	124 0098	£83.60	124 0099	£165.50
4"	124 0100	£28.62	124 0101	£123.80	124 0102	£224.60



Yellow
Max Pressure 6.0 bar

Hose I/D	10m		50m		100m	
	Part No.	Price	Part No.	Price	Part No.	Price
1"	124 0103	£13.50	124 0104	£54.31	124 0105	£104.30
2"	124 0106	£19.00	124 0107	£65.00	124 0108	£97.60
2.1/2"	831 2121	£24.83	831 2125	£126.70	-	-
3"	124 0109	£22.00	124 0110	£95.20	124 0111	£194.10
4"	124 0112	£35.00	124 0113	£145.00	124 0114	£225.20

HOSE STRAINERS



Mild Steel with Heavy Zinc Plating

Part No.	Hose I/D	Price (ea)
833 100	1"	£5.48
833 114	1.1/4"	£5.48
833 112	1.1/2"	£5.72
833 200	2"	£8.50
833 300	3"	£10.95
833 400	4"	£31.13
833 600	6"	£63.57

FOOT VALVE TYPE



Cast Iron Foot Valve Strainers to
Hose Tail

Part No.	Description	Price (ea)
834 200	Strainer for 2" Hose I/D	£25.52
834 300	Strainer for 3" Hose I/D	£42.09
833 222	Leather Clack for 2" Strainer	NLA
833 333	Leather Clack for 3" Strainer	£3.60

Water Pump Couplings



When Ordering BSP Fittings, Measure Across the Thread with a Rule or Vernier.

Please see the Table Below for BSP Thread Sizes - More Measuring Tools Available in Section G.

FEMALE PUMP COUPLINGS



Female Trench Pump Coupling c/w Lugs & Leather Washer. Malleable Iron.

Part No.	Cap Thread	Hose Tail	Price
870 115	1.1/2" BSP	1.1/2"	£9.62
870 200	2" BSP	2"	£9.90
870 300	3" BSP	3"	£17.70
870 400	4" BSP	4"	£48.75

MALE PUMP COUPLINGS



Male Trench Pump Coupling c/w Lugs Malleable Iron

Part No.	Male Thread	Hose Tail	Price
875 115	1.1/2" BSP	1.1/2"	£9.66
875 200	2" BSP	2"	£14.22
875 300	3" BSP	3"	£22.75
875 400	4" BSP	4"	£56.97

TUBE JOINERS



Hose Joiners
Brass, Aluminium or Zinc Plated Steel

Part No.	Hose Tail	Type	Price
814 038	3/8"	Brass	£2.05
814 012	1/2"	Steel	£2.67
814 034	3/4"	Steel	£3.93
814 100	1"	Steel	£3.80
814 114	1.1/4"	Aluminium	£3.05
814 112	1.1/2"	Aluminium	£3.84
814 200	2"	Aluminium	£4.20
814 300	3"	Aluminium	£9.90
814 400	4"	Aluminium	£16.97

British Standard Pipe Thread Sizes

BSP Thread Size	O/D mm/inch	Threads Per Inch
1/16" BSP	7.7mm / 0.304"	28 TPI
1/8" BSP	9.7mm / 0.383"	28 TPI
1/4" BSP	13.16mm / 0.518"	19 TPI
3/8" BSP	16.66mm / 0.656"	19 TPI
1/2" BSP	20.99mm / 0.825"	14 TPI
5/8" BSP	22.99mm / 0.902"	14 TPI
3/4" BSP	26.44mm / 1.041"	14 TPI
1" BSP	33.25mm / 1.309"	11 TPI
1-1/4" BSP	41.91mm / 1.650"	11 TPI
1-1/2" BSP	47.80mm / 1.882"	11 TPI
2" BSP	59.61mm / 2.347"	11 TPI
2-1/4" BSP	65.71mm / 2.587"	11 TPI
2-1/2" BSP	75.18mm / 2.96"	11 TPI
3" BSP	87.88mm / 3.46"	11 TPI
4" BSP	113.03mm / 4.45"	11 TPI
5" BSP	138.43mm / 5.45"	11 TPI
6" BSP	163.83mm / 6.45"	11 TPI

RUBBER WASHERS



Rubber Sealing Washers

Part No.	Coupling Size	Price
829 200	2"	£0.65
829 300	3"	£0.70

LEATHER WASHERS



Leather Sealing Washers

Part No.	Coupling Size	Price
444 101	3/4"	£0.28
830 100	1"	£0.40
830 112	1.1/2"	£0.38
830 200	2"	£0.22
830 300	3"	£0.45
830 400	4"	£0.87

WIDE BAND HOSE CLIP



Heavy Duty Wide Band Hose Clips

Part No.	Suits Hose I/D	Price
813 100	1" Bore Hose	£1.10
813 200	2" Suction Hose	£1.45
813 300	3" Suction Hose	£1.73
813 400	4" Bore Hose	£1.87
813 600	6" Bore Hose	£3.30

HOSECLIP FLEXIDRIVER



7mm Flexi Driver
280mm Long

Part No.	Price
505 120	£8.10

6" DIGITAL VERNIER



Digital Vernier Caliper
LCD Display
Measuring Range 0-150mm (0-6")

Part No.	Price
902 1970	£19.90

Brass Fittings

BRASS CAP & TAIL

Type 444 Brass Female BSP Cap & Hose Tail complete with Leather Washer



Part No.	Cap Thread	Hose Tail	Price
444 012	1/2" BSP	1/2"	£1.50
444 312	3/4" BSP	1/2"	£2.57
444 034	3/4" BSP	3/4"	£2.55
444 734	7/8" BSP	3/4"	£7.70
444 134	1" BSP	3/4"	£5.71
444 100	1" BSP	1"	£2.90
444 114	1.1/4" BSP	1.1/4"	£6.86
444 112	1.1/2" BSP	1.1/2"	£10.30

HEXAGON MALE TO HOSE TAIL

Type 545 Brass Hexagon Male Thread to Hose Tail Connectors



Part No.	Male Thread	Hose Tail	Price
545 014	1/4" BSP	1/4"	£1.12
545 145	1/4" BSP	5/16"	£1.14
545 148	1/4" BSP	3/8"	£1.27
545 142	1/4" BSP	1/2"	£1.32
545 038	3/8" BSP	3/8"	£1.44
545 382	3/8" BSP	1/2"	£4.37
545 128	1/2" BSP	3/8"	£2.02
545 012	1/2" BSP	1/2"	£5.00
545 124	1/2" BSP	3/4"	£3.55
545 032	3/4" BSP	1/2"	£2.99
545 034	3/4" BSP	3/4"	£3.60
545 341	3/4" BSP	1"	£4.22
545 134	1" BSP	3/4"	£4.97
545 154	1" BSP	1.1/4"	£13.43
545 100	1" BSP	1"	£5.32
545 114	1.1/4" BSP	1.1/4"	£8.96
545 141	1.1/4" BSP	1"	£25.36

BRASS BLANKING CAP

Type 343 Brass Blanking Cap c/w Knob & Chain



Part No.	Cap Thread	Price
343 100	1" BSP	£8.79
343 114	1.1/4" BSP	NLA
343 112	1.1/2" BSP	£14.26
343 200	2" BSP	£16.55
343 250	2.1/2" BSP	£23.93
343 300	3" BSP	£24.84

SWIVEL NUT & HOSE TAIL

Type 242 Brass Hexagon Nut & Tail (Flat Seat)



Part No.	Thread	Hose Tail	Price
242 014	1/4" BSP	1/4"	£1.38
242 156	1/4" BSP	5/16"	£1.27
242 314	3/8" BSP	1/4"	£1.87
242 038	3/8" BSP	3/8"	£1.38
242 128	1/2" BSP	3/8"	£2.53
242 012	1/2" BSP	1/2"	£2.05
242 312	3/4" BSP	1/2"	£3.43
242 034	3/4" BSP	3/4"	£3.73
242 134	1" BSP	3/4"	£7.03
242 100	1" BSP	1"	£6.20

MALE/MALE EQUAL ADAPTOR

Type 141 Brass Double Male Nipple. Parallel BSP Thread with Hex Centre

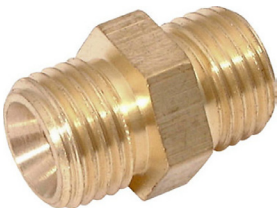

Part No.	Thread	Price
141 014	1/4" BSP	£1.50
141 038	3/8" BSP	£1.93
141 012	1/2" BSP	£1.98
141 034	3/4" BSP	£4.19
141 100	1" BSP	£3.99

Camlock Couplings

FEMALE THREADED PLUG



Aluminium Female Threaded Cam & Groove Plug - Type A

Part No.	Thread	Price
880 034	3/4"	£2.58
880 100	1"	£2.75
880 112	1.1/2"	£4.03
880 200	2"	£4.10
880 300	3"	£8.07

PLUG TO HOSE TAIL



Aluminium Cam & Groove Plug to Hose Tail - Type E

Part No.	Thread	Price
884 034	3/4"	£2.40
884 100	1"	£2.92
884 112	1.1/2"	£5.72
884 200	2"	£5.92
884 300	3"	£12.48

MALE THREADED COUPLING



Aluminium Male Threaded Cam & Groove Lever Coupling - Type B

Part No.	Thread	Price
881 034	3/4"	£5.61
881 100	1"	£6.15
881 112	1.1/2"	£8.99
881 200	2"	£8.45
881 300	3"	£15.25

MALE THREADED PLUG



Aluminium Male Threaded Cam & Groove Plug - Type F

Part No.	Thread	Price
885 034	3/4"	£3.06
885 100	1"	£3.02
885 112	1.1/2"	£3.75
885 200	2"	£4.42
885 300	3"	£10.78

HOSE TAIL POLY COUPLING



2" Poly Camlock Coupling to 2" Hose Tail - Type C

Part No.	Price
600 022	£8.23

FEMALE CAP

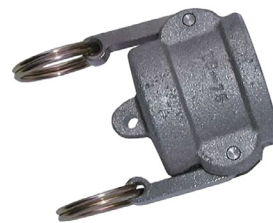

Aluminium Cam & Groove Lever Cap

Part No.	Size	Price
879 034	3/4"	£5.04
879 100	1"	£5.25
879 112	1.1/2"	£7.05
879 200	2"	£9.33
879 300	3"	£12.50

HOSE TAIL LEVER COUPLING



Aluminium Cam & Groove Lever Coupling to Hose Tail - Type C

Part No.	Tail	Price
882 034	3/4"	£5.18
882 100	1"	£5.87
882 112	1.1/2"	£8.47
882 200	2"	£9.10
882 300	3"	£17.92

MALE PLUG



Aluminium Cam & Groove Blanking Plug

Part No.	Size	Price
889 034	3/4"	£2.15
889 100	1"	£2.68
889 112	1.1/2"	£3.43
889 200	2"	£3.80
889 300	3"	£7.40

FEMALE THREADED COUPLING



Aluminium Female Threaded Cam & Groove Lever Coupling - Type D

Part No.	Thread	Price
883 034	3/4"	£6.68
883 100	1"	£6.10
883 112	1.1/2"	£9.75
883 200	2"	£8.77
883 300	3"	£16.27

RUBBER CAMLOCK SEALS



High Quality Rubber Camlock Coupling Seals

Part No.	Size	Price
886 200	2" Seal	£0.60
886 300	3" Seal	£1.17

Lever Lock Couplings

FEMALE TO HOSE TAIL



Bauer Type Coupling - Galvanised
Female to Hose Tail
O Ring Supplied Separately

Part No.	Size	Hose I/D	Price
474 200	2"	2"	£9.92
474 300	3"	3"	£16.95
474 400	4"	4"	£20.68
474 600	6"	6"	£37.59

MALE TO MALE BSP C/W LEVER



Bauer Type Coupling - Galvanised
Female to Male Threaded Pipe c/w
Locking Ring
O Ring Supplied Separately

Part No.	Size	Thread	Price
272 200	2"	2"	£34.04
272 300	3"	3"	£47.92
272 400	4"	4"	£88.90
272 600	6"	6"	£125.00

MALE TO HOSE TAIL



Bauer Type Coupling - Galvanised
Male to Hose Tail

Part No.	Size	Hose I/D	Price
575 200	2"	2"	£9.12
575 300	3"	3"	£16.95
575 400	4"	4"	£20.68
575 600	6"	6"	£37.60

COMPLETE CONNECTION SET



Bauer Type Coupling - Galvanised
Complete Connection Set
Supplied with O Ring

Part No.	Size	Hose I/D	Price
878 200	2"	2"	£32.05
878 300	3"	3"	£54.36
878 400	4"	4"	£67.20
878 600	6"	6"	£120.30

FEMALE TO MALE THREADED



Bauer Type Coupling - Galvanised
Female to Male Threaded Pipe
O Ring Supplied Separately

Part No.	Size	Thread	Price
171 200	2"	2" BSP	£22.26
171 300	3"	3" BSP	£35.93
171 400	4"	4" BSP	£44.91
171 600	6"	6" BSP	£74.07

LEVER LOCK O RINGS



Replacement O Rings

Part No.	Size	O/D	I/D	Price
777 200	2"	80mm	62mm	£1.05
777 300	3"	134mm	108mm	£2.83
777 400	4"	162mm	132mm	£3.06
777 600	6"	208mm	170mm	£6.20

LEVER CLOSURE RING



Locking Ring - Galvanised

Part No.	Size	Price
676 200	2"	£14.93
676 300	3"	£21.57
676 400	4"	£26.80
676 600	6"	£51.42

WATER PUMP PLIERS



300mm Long
Hardened Chrome Vanadium Steel
Non Slip Handles

Part No.	Price
902 1809	£14.43

Malleable Iron Fittings

WELDABLE SOCKETS



Weldable Female Sockets
Black
Type 181

Part No.	Size	Price
181 018	1/8" BSP	£0.90
181 014	1/4" BSP	£0.75
181 038	3/8" BSP	£1.00
181 012	1/2" BSP	£0.95
181 034	3/4" BSP	£1.30
181 100	1" BSP	£1.55
181 114	1.1/4" BSP	£2.85
181 112	1.1/2" BSP	£3.45
181 200	2" BSP	£5.00
181 300	3" BSP	£9.90
181 400	4" BSP	£15.90

BLANKING CAPS



Maleable Iron Blanking Caps
Black
Type 989

Part No.	Size	Price
989 014	1/4" BSP	£0.90
989 038	3/8" BSP	£0.90
989 012	1/2" BSP	£1.00
989 034	3/4" BSP	£1.15
989 100	1" BSP	£1.50
989 114	1.1/4" BSP	£2.25
989 112	1.1/2" BSP	£2.40
989 200	2" BSP	£4.45
989 300	3" BSP	£12.99

EQUAL TEES



Maleable Iron Equal Female Tees
Black, Type 787
Unequal Tees also available

Part No.	Size	Price
787 038	3/8" BSP	£1.60
787 012	1/2" BSP	£1.65
787 034	3/4" BSP	£1.80
787 100	1" BSP	£2.65
787 112	1.1/2" BSP	£5.40
787 200	2" BSP	£7.50
787 300	3" BSP	£20.50

BARREL NIPPLES



Maleable Iron Barrel Nipples
Black
Type 282

Part No.	Size	Price
282 018	1/8" BSP	£1.25
282 014	1/4" BSP	£1.25
282 038	3/8" BSP	£1.25
282 012	1/2" BSP	£1.30
282 034	3/4" BSP	£1.30
282 100	1" BSP	£1.80
282 114	1.1/4" BSP	£2.25
282 112	1.1/2" BSP	£2.85
282 200	2" BSP	£3.90
282 300	3" BSP	£8.27
282 400	4" BSP	£15.70

SQUARE HEAD PLUGS



Maleable Iron Square Headed Plugs
Black, Type 888

Part No.	Male	Price
888 018	1/8" BSP	£0.62
888 014	1/4" BSP	£0.78
888 038	3/8" BSP	£1.21
888 012	1/2" BSP	£0.85
888 034	3/4" BSP	£1.05
888 100	1" BSP	£1.25
888 112	1.1/2" BSP	£2.64
888 200	2" BSP	£3.70
888 300	3" BSP	£12.10
888 301	4" BSP	£30.40

REDUCING HEX BUSHES



Maleable Iron Male/Female Reducing
Hex Bushes
Black
Type 383

Part No.	Male	Female	Price
383 314	3/8" BSP	1/4" BSP	£0.95
383 128	1/2" BSP	3/8" BSP	£1.08
383 312	3/4" BSP	1/2" BSP	£1.14
383 134	1" BSP	3/4" BSP	£1.60
383 121	1.1/2" BSP	1" BSP	£2.65
383 212	2" BSP	1.1/2" BSP	£3.50
383 302	3" BSP	2" BSP	£10.44
383 403	4" BSP	3" BSP	£15.70

When Ordering BSP Fittings, Measure Across the Thread with a Rule or Vernier. Full BSP Size Table on Water Pump Couplings Page.



3/8" BSP will measure 16.66mm / 0.656" (19 TPI)
1/2" BSP will measure 20.99mm / 0.825" (14 TPI)
3/4" BSP will measure 26.44mm / 1.041" (14 TPI)
1" BSP will measure 33.25mm / 1.309" (11 TPI)

Malleable Iron Fittings

EQUAL HEX NIPPLE



Maleable Iron Equal Hex Nipples
Black
Type 484

Part No.	Size	Price
484 014	1/4" BSP	£1.00
484 038	3/8" BSP	£1.15
484 012	1/2" BSP	£1.15
484 034	3/4" BSP	£1.20
484 100	1" BSP	£1.70
484 114	1.1/4" BSP	£2.65
484 112	1.1/2" BSP	£3.05
484 200	2" BSP	£4.72
484 300	3" BSP	£10.04
484 400	4" BSP	£21.91

REDUCING HEX NIPPLE



Maleable Iron Reducing Hex Nipples
Black
Type 585

Part No.	Male	Female	Price
585 148	1/4"	1/8"	£1.40
585 314	3/8"	1/4"	£1.40
585 128	1/2"	3/8"	£1.85
585 312	3/4"	1/2"	£1.82
585 112	1"	1/2"	£2.90
585 134	1"	3/4"	£2.60
585 141	1.1/4"	1"	£2.85
585 121	1.1/2"	1"	£5.05
585 124	1.1/2"	1.1/4"	£3.30
585 201	2"	1"	£5.44
585 212	2"	1.1/2"	£6.85
585 302	3"	2"	£21.22

MALE/FEMALE ELBOW



Maleable Iron Male/Female Elbow
Black
Type 686

Part No.	Male	Female	Price
686 014	1/4" BSP	1/4" BSP	£1.30
686 038	3/8"	3/8"	£1.50
686 012	1/2"	1/2"	£1.30
686 034	3/4"	3/4"	£1.55
686 100	1"	1"	£2.67
686 112	1.1/2"	1.1/2"	£4.98
686 200	2"	2"	£6.80
686 300	3"	3"	£21.75
686 400	4"	4"	£44.52

LEVER BALL VALVES



Suitable for Water, Air-Conditioning
Plant, Heating & Compressed Air
Systems

Part No.	Size	Price
850 014	1/4" BSP	£3.30
850 038	3/8" BSP	£3.40
850 012	1/2" BSP	£4.64
850 034	3/4" BSP	£6.73
850 100	1" BSP	£9.32
850 114	1.1/4" BSP	£16.51
850 112	1.1/2" BSP	£21.58
850 222	2" BSP	£35.00
850 300	3" BSP	£112.80
850 400	4" BSP	£187.80

BRASS WHEEL GATE VALVES



Operating Range -20 °C to +100 °C
Working Pressure 240 psi

Part No.	Size	Price
860 014	1/4" BSP	£5.41
860 038	3/8" BSP	£5.70
860 012	1/2" BSP	£5.80
860 034	3/4" BSP	£7.72
860 100	1" BSP	£10.92
860 114	1.1/4" BSP	£14.29
860 112	1.1/2" BSP	£23.20
860 200	2" BSP	£39.28
860 300	3" BSP	£73.85

PTFE TAPE



PTFE Thread Sealing Tape
12mm x 12m Roll on a Plastic
Spool

Part No.	Price
865 130	£0.35

Geka Type Water Couplings

MALE THREADED



Brass Coupling, Male Threaded
Fully compatible with Geka, Renus and Velox quick connect water fittings

Part No.	Size	Price
062 306	3/8" BSP	£3.78
062 301	1/2" BSP	£2.95
062 302	3/4" BSP	£2.93
062 304	1" BSP	£3.02

FEMALE THREADED



Brass Coupling, Female Threaded
Fully compatible with Geka, Renus and Velox quick connect water fittings

Part No.	Size	Price
062 401	1/2" BSP	£2.64
062 402	3/4" BSP	£2.75
062 406	7/8" BSP	£9.50
062 404	1" BSP	£3.10
062 403	1.1/4" BSP	£6.00
062 405	1.1/2" BSP	£9.32

HOSE TAIL



Brass Coupling, Hose Tail
Fully compatible with Geka, Renus and Velox quick connect water fittings

Part No.	Size	Price
062 506	3/8" BSP	£3.45
062 501	1/2" BSP	£2.95
062 502	3/4" BSP	£3.10
062 503	1" BSP	£3.66

BLANKING CAP



Lockable Blanking Cap
Fully compatible with Geka, Renus and Velox quick connect water fittings

Part No.	Price
062 512	£5.21

SPRAY NOZZLE



Adjustable Spray Nozzle
Fully compatible with Geka, Renus and Velox quick connect water fittings

Part No.	Price
062 802	£15.02

RUBBER SEAL



Replacement Rubber Seal - Suits All Sizes
Fully compatible with Geka, Renus and Velox quick connect water fittings

Part No.	Price
062 511	£0.42

TRIPLE OUTLET CONNECTOR



Brass 3-Way Coupling
Fully compatible with Geka, Renus and Velox quick connect water fittings

Size: 3 x 3/4" Outlets

Part No.	Price
062 510	£31.03

BRASS NOZZLE - FIXED



Heavy Duty Brass Hose Nozzle, non adjustable with serrated hose tail fitting

Part No.	Hose Tail	Price
041 001	1/2"	£4.50
041 003	3/4"	£6.85
041 004	1"	£9.90

BRASS NOZZLE - ADJUSTABLE



Adjustable Brass Spray Nozzle
Serrated hose tail fitting
Nozzle can be twisted to completely shut off water flow

Part No.	Hose Tail	Price
040 401	1/2"	£5.50
040 402	3/4"	£13.82

Garden Hose Fittings



General Purpose 1/2" Garden Hose

General purpose 1/2" bore triple layered reinforced PVC garden hose
Max pressure 20 bar at 20°C
Exceeds BS3746 1990 standards

Part No.	Length	Price
290 063	15m	£28.35
290 064	30m	£27.72
290 065	50m	£49.20

STEEL HOSE REEL



Steel Hose Reel
Wall Mounted
Stores 75m Garden Hose

Part No.	Price
300 660	£43.88

RETRACTABLE HOSE REEL



Retractable Hose Reel
Wall Mounted
Includes 20m Hose & Spray Nozzle

Part No.	Price
010 100	£145.90

Brass Female Hozelock Type Connector with Auto Stop Fits 1/2" Garden Hose	Brass Male Hozelock Type Connector Fits 1/2" Garden Hose	Brass Hose to Hose Quick Connector Set Fits 1/2" Garden Hose	Brass Male/Male Hozelock Type Connector	Brass Hose Repair Connector for 1/2" Garden Hose
290 067 £3.95	290 098 £6.23	290 070 £13.57	290 096 NLA	290 097 NLA
Triple Hose Connector For joining Hose fitted with Female Connectors	3/4" BSP Brass Tap Connector Male Hozelock Fitting	Clamp Type Tap Connector (10-20mm) Male Hozelock Fitting	15mm Compression to 1/2" Female Brass Wallplate Elbow for 1/2" Babcock Tap	Brass Bibcock Tap - 1/2" Male to 1/2" Garden Hose
290 068 £5.70	290 072 £3.40	290 066 £13.57	290 074 £2.36	290 069 £5.48
All Rubber Wash Down Gun with Adjustable Nozzle Male Hozelock Fitting	Metal Wash Down Gun Adjustable Nozzle with Rubber Grip Male Hozelock Fitting	Heavy Duty Wash Down Gun 1/2" BSP Inlet 26 bar/360psi Max	Solid Brass Spray Nozzle Adjustable Spray/Jet Male End	Plastic Connector Kit 3/4" BSP Tap, Nozzle, Male/Male & 2 Female Hozelock Type Fittings
300 5555 £18.85	300 5666 £24.68	300 6700 £37.17	290 076 £5.07	605 040 £3.75

Hose & Tubing

Clear Braided Nylon Tubing

Reinforced PVC



Part No.	I/D	Pressure	Length	Price
605 096	3/16" (5mm)	16 bar	30m	£21.12
605 097	1/4" (6mm)	16 bar	30m	£13.94
605 098	5/16" (8mm)	16 bar	30m	£16.22
605 099	3/8" (10mm)	15 bar	30m	£19.50
124 0042	1/2" (12.5mm)	12 bar	30m	£50.57
124 0010	3/4" (19mm)	10 bar	30m	£65.42
124 0012	1" (25mm)	10 bar	30m	£62.00

CLEAR PVC TUBING



Suitable for Windscreen Washers

Part No.	I/D	Length	Price
775 111	3mm	30m	£11.17
775 113	4mm	30m	£12.27
775 112	5mm	30m	£12.27
775 108	6mm	30m	£15.40
775 115	13mm	30m	£29.48

HEATER HOSE



Coolant Resistant
From -40°C to 100°C

Part No.	O/D	Length	Price
605 090	1/2" (13mm)	20m	£52.83
605 091	5/8" (16mm)	20m	£59.00
605 093	3/4" (19mm)	20m	£82.92

NYLON TUBING - IMPERIAL



Imperial Natural Semi Rigid Nylon Tubing
Suitable for Lube, Air & Fuel Line

Part No.	I/D	O/D	Length	Price
605 221	1/8"	3/16"	30m	£21.55
605 222	5/32"	1/4"	15m	£13.52
605 223	7/32"	5/16"	15m	£17.85
605 224	5/16"	3/8"	15m	£25.75
605 225	23/64"	1/2"	15m	£44.75

RUBBER FUEL HOSE



Approved to
BSAU 108/2/L4/C4/R
Temperature Range -20°C to 100°C

Part No.	I/D	Length	Price
605 105	3/16" (5mm)	10m	£17.92
605 106	1/4" (6mm)	10m	£22.05
605 107	5/16" (8mm)	10m	£25.55
605 108	3/8" (10mm)	10m	£31.63

NYLON TUBING - METRIC



Metric Natural Semi Rigid Nylon Tubing
Suitable for Lube, Air & Fuel Line

Part No.	I/D	O/D	Length	Price
605 297	4mm	6mm	15m	£11.73
605 298	5.5mm	8mm	15m	£24.02
605 299	8mm	10mm	15m	£20.48
605 300	9mm	12mm	15m	£37.48

BRAIDED LEAK OFF PIPE



Cotton Overbraided Fuel Pipe
Suitable for Diesel, Petrol & Oil
DIN SPEC 73379 TYPE B 1983
10 Bar / 50 psi WP

Part No.	I/D	Length	Price
200 437	3.2mm	5m	£8.82
200 438	3.5mm	5m	£9.98
200 439	5mm	5m	£12.01
200 440	6mm	5m	£12.00
200 441	8mm	5m	£13.00
200 442	10mm	5m	£15.25

RUBBER FUEL PIPE



Black Rubber Fuel Hose

Part No.	I/D	O/D	Length	Price
124 0003	3.1mm	6.3mm	1m Cut	£5.99
124 0004	3.1mm	6.3mm	5m Roll	£29.96
124 0005	4.7mm	9.5mm	1m Cut	£4.40
124 0006	4.7mm	9.5mm	5m Roll	£45.19
124 0007	6.3mm	12.7mm	1m Cut	£5.34
124 0008	6.3mm	12.7mm	4m Roll	£18.68

VINYLON FUEL PIPE



High Performance Fuel Hose for Garden Machinery & Small Engines

Part No.	I/D	O/D	Length	Price
124 0013	3.1mm	4.7mm	1m Cut	£2.25
124 0014	3.1mm	4.7mm	15m Roll	£69.80
124 0015	4.7mm	8mm	1m Cut	£2.25
124 0016	4.7mm	8mm	15m Roll	£39.12
124 0017	6.3mm	9.5mm	1m Cut	£2.65
124 0018	6.3mm	9.5mm	15m Roll	£39.00

PIPE CLIPS



Fuel Pipe Spring Clips
(Sold Each)

Part No.	O/D	Price
355 182	5mm	£0.27
355 1710	6mm	£0.30
320 219	8mm	£0.45
355 183	10mm	£0.27
320 218	12mm	£0.50
355 1289	13mm	£0.27
355 2100	Assorted (120pc)	£35.00

Hose & Tubing

OVERBRAIDED FUEL HOSE



Automotive Fuel And Oil Hose
Smooth Synthetic Nitrile
Black Rubber
Din 73379 Type B
10 Bar / 145 psi WP

Part No.	I/D	Length	Price
124 0256	3.2mm	20m	£39.22
124 0257	3.5mm	20m	£38.80
124 0258	4mm	20m	£40.00
124 0259	4.5mm	20m	£48.41
124 0260	5mm	20m	£47.67
124 0261	5.5mm	20m	£48.76
124 0262	6mm	20m	£50.88
124 0263	7mm	20m	£56.65
124 0264	7.5mm	20m	£54.77
124 0265	8mm	20m	£60.33
124 0266	9mm	20m	£71.96
124 0267	10mm	20m	£81.64
124 0268	12mm	20m	£120.80

FUEL HOSE - DIESEL



1 Inch Bore Black Diesel Hose
Without any connections
or fittings
7 Bar / 105 psi WP

Part No.	I/D	Length	Price
124 0308	1"	5m Roll	£33.92
124 0309	1"	10m Roll	£95.20
124 0310	1"	25m Roll	£159.70

FUEL HOSE - PETROL



Automotive Petrol-Fuel-Oil Hose
BSAU108 / SAEJ30R6
Highly Resistant To Oil & Fuel
Temp Range: -30°C To +90°C
20 Bar / 115 psi WP

Part No.	I/D	Length	Price
605 310	3/16" (5mm)	10m	£14.94
605 315	3/16" (6mm)	10m	£17.14
605 320	5/16" (8mm)	10m	£19.08
605 325	3/8" (10mm)	10m	£22.49
605 330	1/2" (13mm)	10m	£31.07

ADBLUE HOSE



Reinforced PVC Hose For
The Transference Of Adblue
7 Bar / 102 psi WP

Part No.	I/D	Length	Price
124 0333	3/4" (19mm)	50m	POA

CAR HEATER HOSE



For The Conveyance Of Hot
Water For Vehicle Use
Heat Resistant EPDM Rubber
Synthetic Textile SAE J20 R3
10 Bar / 145 psi WP

Part No.	I/D	Length	Price
124 0269	3/8" (10mm)	100m	£226.40
124 0270	3/8" (10mm)	20m	£54.41
124 0271	5/8" (16mm)	100m	£259.80
124 0272	5/8" (16mm)	20m	£59.58
124 0273	3/4" (19mm)	50m	£178.70
124 0274	3/4" (19mm)	20m	£81.70

OIL SUCTION HOSE



Oil Delivery and Suction Hose
Oil and Petrol Resistant
Conductive Synthetic
Nitrile Black Rubber
10 Bar / 145 psi WP

Part No.	I/D	Length	Price
117 3405	3/4" (19mm)	5m	£60.95
117 0105	1" (25mm)	5m	£61.71
117 1125	1 1/2" (38mm)	5m	£77.39
117 0205	2" (51mm)	5m	£101.80

Hose & Tubing

RADIATOR HOSE



Radiator Hose for Automotive
And Industrial Engines
EPDM Based Rubber
4 Bar / 58 psi WP

Part No.	I/D	Length	Price
124 0178	13mm	1m Cut	£7.21
124 0179	16mm	1m Cut	£7.46
124 0180	19mm	1m Cut	£7.47
124 0181	22mm	1m Cut	£8.59
124 0193	22mm	10m Roll	£62.50
124 0182	25mm	1m Cut	£9.77
124 0183	28mm	1m Cut	£9.60
124 0194	28mm	10m Roll	£79.00
124 0184	30mm	1m Cut	£10.48
124 0185	32mm	1m Cut	£11.51
124 0195	32mm	10m Roll	£82.50
124 0186	35mm	1m Cut	£11.82
124 0187	38mm	1m Cut	£13.54
124 0188	40mm	1m Cut	£14.23
124 0189	42mm	1m Cut	£13.64
124 0190	45mm	1m Cut	£15.14
124 0191	48mm	1m Cut	£15.44
124 0196	51mm	1m Cut	£14.73
124 0197	55mm	1m Cut	£15.52
124 0198	57mm	1m Cut	£16.15
124 0199	60mm	1m Cut	£16.98
124 0200	63mm	1m Cut	£17.57
124 0201	70mm	1m Cut	£17.91
124 0202	73mm	1m Cut	NLA
124 0203	76mm	1m Cut	£21.95
124 0204	80mm	1m Cut	£21.57
124 0205	90mm	1m Cut	£26.90

Other Lengths and Sizes Available

COOLING SYSTEM HOSE



Silicone Automotive Cooling
System Hose
Hose Reinforced With
100% Polyester Yarn

Part No.	I/D	Length	Price
124 0206	6.5mm	1m Cut	£11.99
124 0207	8mm	1m Cut	£13.80
124 0208	9.5mm	1m Cut	£15.88
124 0209	11mm	1m Cut	£15.82
124 0210	13mm	1m Cut	£19.57
124 0211	16mm	1m Cut	£20.84
124 0212	19mm	1m Cut	£22.51
124 0213	22mm	1m Cut	£24.23
124 0214	25mm	1m Cut	£25.65
124 0215	28mm	1m Cut	£27.58
124 0216	30mm	1m Cut	£28.76
124 0217	32mm	1m Cut	£30.39
124 0218	35mm	1m Cut	£34.04
124 0219	38mm	1m Cut	£35.03
124 0220	40mm	1m Cut	£36.96
124 0221	45mm	1m Cut	£39.42
124 0222	48mm	1m Cut	£42.01
124 0223	51mm	1m Cut	£48.36
124 0224	54mm	1m Cut	£50.66
124 0225	57mm	1m Cut	£53.93
124 0226	60mm	1m Cut	£56.86
124 0227	63mm	1m Cut	£59.07
124 0228	65mm	1m Cut	£62.67
124 0229	68mm	1m Cut	£65.97
124 0230	70mm	1m Cut	£68.22
124 0231	76mm	1m Cut	£72.09

Other Lengths and Sizes Available

COOLING SYSTEM ELBOW



90 Deg Automotive Cooling
152mm Legs
System Silicone Elbow
Hose Reinforced With
100% Polyester Yarn

Part No.	I/D	Price
605 336	6.5mm	£13.99
605 341	8mm	£13.99
605 346	9.5mm	£15.35
605 351	11mm	£13.99
605 356	13mm	£15.22
605 361	16mm	£15.22
605 366	19mm	£15.53
605 371	22mm	£17.00
605 376	25mm	£18.16
605 381	28mm	£18.07
605 386	30mm	£18.71
605 391	32mm	£19.13
605 396	35mm	£20.27
605 401	38mm	£20.20
605 406	40mm	£22.59
605 411	45mm	£23.35
605 416	48mm	£26.75
605 421	51mm	£30.06
605 426	54mm	£32.02
605 431	57mm	£34.36
605 436	60mm	£35.36
605 441	63mm	£36.52
605 446	65mm	£37.70
605 451	68mm	£39.43
605 456	70mm	£41.26
605 461	76mm	£45.80
605 466	80mm	£45.85
605 471	83mm	£46.97
605 476	89mm	£49.31
605 481	90mm	£51.53
605 486	102mm	£51.30
605 491	114mm	£46.25

SYNTHETIC AIRLINE HOSE



Synthetic Compressor and Air Tools
Hose. Colour May Vary.
20bar / 300psi WP

Part No.	I/D	Length	Price
124 0232	6.3mm	20m	£26.31
124 0233	8mm	20m	£27.56
124 0234	10mm	20m	£34.63
124 0235	13mm	20m	£45.93

Hose & Tubing

MULTI PURPOSE HOSE



Multi Purpose Anti Static
Suitable for Oil, Fuel, Air and Water
25 Bar / 360 psi WP

Part No.	I/D	Length	Price
116 0605	6mm	5m	£28.05
116 0620	6mm	20m	£56.10
116 0805	8mm	5m	£19.33
116 0820	8mm	20m	£79.65
116 1005	10mm	5m	£20.14
116 1020	10mm	20m	£78.28
116 1305	13mm	5m	£23.59
116 1320	13mm	20m	£90.60
116 1905	19mm	5m	£41.20
116 1920	19mm	20m	£158.20
116 2505	25mm	5m	£50.43

SUPERFLEX PVC DUCTING



Smooth Bore PVC Spiral
Ducting Suitable for Industrial
Ventilation and Airflow Systems

Part No.	I/D	Length	Price
124 0236	19mm	1m Cut	£3.06
124 0237	25mm	1m Cut	£3.87
124 0238	32mm	1m Cut	£3.89
124 0239	38mm	1m Cut	£4.82
124 0240	40mm	1m Cut	£5.67
124 0241	51mm	1m Cut	£6.91
124 0242	55mm	1m Cut	£8.75
124 0243	63mm	1m Cut	£9.51
124 0244	70mm	1m Cut	£10.20
124 0245	76mm	1m Cut	£11.22
124 0246	90mm	1m Cut	£14.97
124 0247	102mm	1m Cut	£16.52
124 0248	127mm	1m Cut	£27.04
124 0249	152mm	1m Cut	£31.16
124 0250	203mm	1m Cut	£43.56

Other Lengths Available

INDUSTRIAL VACUUM HOSE



For Industrial Vacuum Cleaners
Also Suitable For Use For
Swimming Pool Cleaning

Part No.	I/D	Description	Price
605 1225	32mm	10m Hose Only	£94.00
605 1226	32mm	Cuff	£15.57
605 1230	38mm	10m Hose Only	£105.50
605 1231	38mm	Cuff	£18.90
605 1235	51mm	10m Hose Only	£155.30
605 1236	51mm	Cuff	£43.39

TRANSPARENT PVC DUCTING



Transparent Smooth Bore
PVC Spiral Ducting Suitable for
Industrial Ventilation and
Airflow Systems

Part No.	I/D	Length	Price
124 0251	25mm	20m	£159.70
124 0252	32mm	20m	£158.40
124 0253	38mm	20m	£222.90
124 0254	51mm	20m	£253.60
124 0255	63mm	20m	£387.50

Other Sizes Available

HOSE PROTECTOR



Polypropylene Spiral
Hose Protector

Part No.	I/D	Length	Colour	Price
124 0021	16-20mm	5m	Yellow	£13.36
124 0022	16-20mm	20m	Yellow	£42.70
124 0023	20-25mm	5m	Yellow	£16.64
124 0024	20-25mm	20m	Yellow	£50.24
124 0025	25-34mm	5m	Yellow	£17.40
124 0026	25-34mm	20m	Yellow	£70.26
124 0027	32-43mm	5m	Yellow	£24.98
124 0028	32-43mm	20m	Yellow	£96.00
124 0029	12-15mm	5m	Black	£7.90
124 0030	12-15mm	20m	Black	£37.25
124 0031	16-20mm	5m	Black	£11.47
124 0032	16-20mm	20m	Black	£38.21
124 0033	20-25mm	5m	Black	£14.40
124 0034	20-25mm	20m	Black	£46.85
124 0035	25-34mm	5m	Black	£15.95
124 0036	25-34mm	20m	Black	£63.77
124 0037	32-43mm	5m	Black	£24.99
124 0038	32-43mm	20m	Black	£96.00
124 0039	42-54mm	5m	Black	£35.47
124 0040	42-54mm	10m	Black	£70.93

REINFORCED BRAIDED HOSE



Clear Reinforced Braided Hose
Reinforced with a Galvanised
Steel Wire Helix, for Suction
and Delivery of Food Liquids.

Part No.	I/D	Pressure	Length	Price
121 1310	12mm	21 Bar	10m	£27.81
121 5810	16mm	18 Bar	10m	£41.50
121 3410	19mm	15 Bar	10m	£52.50
121 2510	25mm	15 Bar	10m	£81.90
121 3811	38mm	12 Bar	10m	£113.70
121 5110	51mm	9 Bar	10m	£150.50

TIGER TAIL SANITATION HOSE



2" Hose x 15m Length
Used To Transfer Liquids/
Effluent For Sanitation And
Cesspool Purposes.

Part No.	Price
605 1265	£369.50

Hose Clips

HOSE CLIPS



Mild Steel with Heavy Zinc Plating

Part No.	Size	Price (ea)
JC 000	9.5 - 12mm	£0.54
JC M00	11 - 16mm	£0.56
JC 00	13 - 20mm	£0.60
JC 0	16 - 22mm	£0.60
JC 0X	18 - 25mm	£0.63
JC 1A	22 - 30mm	£0.74
JC 1	25 - 35mm	£0.85
JC 1X	30 - 40mm	£0.82
JC 2A	35 - 50mm	£1.00
JC 2	40 - 55mm	£0.98
JC 2X	45 - 60mm	£0.98
JC 3	55 - 70mm	£1.06
JC 3X	60 - 80mm	£1.22
JC 4	70 - 90mm	£1.21
JC 4X	85 - 100mm	£1.31
JC 5	90 - 120mm	£1.41
JC 6	110 - 130mm	£1.73
JC 7	140 - 160mm	£1.82
JC 8	160 - 180mm	£2.50
JC 9	180 - 205mm	£2.65

ASSORTED SMALL CLIPS



Assorted Pack of 50 Small Clips
Zinc Plated
Sizes: 12 (000), 16 (M00), 20 (00),
22 (0), 25 (0X), 30 (1A), 35 (1),
40 (1X), 50 (2A), 55 (2)

Part No.	Price
110 136	£26.40

ASSORTED LARGE CLIPS



Assorted Pack of 24 Large Clips
Zinc Plated
Sizes: 60, 70, 80, 90, 100, 120,
140, 160 (2X, 3, 3X, 4, 4X, 5, 6, 7)

Part No.	Price
110 137	£24.53

HOSE CLIP DISPENSER



JUBILEE Hose Clip Dispenser
100 Clip with Flexi Driver
Mild Steel, Zinc Plated
Contains 10 of Each Sizes: 12, 16,
20, 22, 25, 30, 35, 40, 50, 55

Part No.	Price
110 163	£107.60

HOSECLIP FLEXIDRIVER



7mm Flexi Driver
280mm Long

Part No.	Price
505 120	£8.10

MINI HOSE CLIPS



Mild Steel with Heavy Zinc Plating

Part No.	Size	Price (ea)
505 161	7 - 9mm	£0.30
505 162	8 - 10mm	£0.28
505 163	9 - 11mm	£0.30
505 164	10 - 12mm	£0.30
505 165	11 - 13mm	£0.32
505 166	12 - 14mm	£0.30
505 167	13 - 15mm	£0.27
505 168	14 - 16mm	£0.30
505 169	15 - 17mm	£0.30
505 170	16 - 18mm	£0.30

WIDE BAND HOSE CLIPS



Heavy Duty Wide Band Hose Clips

Part No.	Suits Hose I/D	Price
813 100	1" Bore Hose	£1.10
813 150	To Suit 2" Layflat (52-55mm)	£1.40
813 200	2" Suction Hose	£1.45
813 250	To Suit 3" Layflat (74-79mm)	£1.75
813 300	3" Suction Hose	£1.73
813 400	4" Bore Hose	£1.87
813 600	6" Bore Hose	£3.30

Tube Fittings

BRASS TUBE COUPLINGS



Brass Tube Couplings with Stepped Olives

Part No.	Tube Ø	Price
615 226	5/32"	£1.55
615 227	3/16"	£4.10
615 228	1/4"	£3.39
615 229	5/16"	£3.39
615 130	3/8"	£4.05
615 231	1/2"	£6.61
615 289	5/8"	£7.75
615 279	4mm	£2.47
615 280	6mm	£3.10
615 181	8mm	£2.60
615 182	10mm	£4.72

SPEEDFIT ELBOWS



Equal Elbow SPEEDFIT Couplings

Part No.	Tube Ø	Price
625 223	5/32"	£1.10
625 224	3/16"	£1.15
625 225	1/4"	£1.50
625 226	5/16"	NLA
625 227	3/8"	NLA
625 228	1/2"	£2.35
625 229	4mm	£2.02
625 230	6mm	£2.56
625 231	8mm	£2.71
625 232	10mm	£3.03
625 233	12mm	£3.57

PLASTIC HOSE JOINER



Hose Repair Straight Joiner
Max Pressure 14 Bar
Max Temp 100°C

Part No.	Hose Ø	Price
775 201	6mm	£0.76
775 211	8mm	£0.76
775 221	10mm	£1.32
775 231	12mm	£1.76

SPEEDFIT COUPLINGS



Equal Straight SPEEDFIT Couplings

Part No.	Tube Ø	Price
625 206	5/32"	£1.62
625 207	3/16"	£1.46
625 208	1/4"	£1.78
625 209	5/16"	£1.75
625 210	3/8"	£2.44
625 211	1/2"	£2.70
625 201	4mm	£1.41
625 200	5mm	£1.60
625 202	6mm	£1.66
625 203	8mm	£1.87
625 204	10mm	£2.47

PLASTIC TEE PIECE

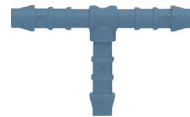

Tee Piece Connector
Max Pressure 14 Bar
Max Temp 100°C

Part No.	Hose Ø	Price
775 200	6mm	£0.80
775 210	8mm	£0.92
775 220	10mm	£0.92
775 240	12mm	£1.04

SPEEDFIT TEE PIECES



Equal Tee SPEEDFIT Couplings

Part No.	Tube Ø	Price
625 212	5/32"	£1.45
625 213	3/16"	£1.55
625 215	5/16"	£1.70
625 216	3/8"	£2.20
625 217	1/2"	£2.50
625 218	4mm	£2.56
625 219	6mm	£2.50
625 220	8mm	£2.73
625 221	10mm	£3.03
625 222	12mm	£3.75

PLASTIC Y PIECE



Y Piece Connector
Max Pressure 14 Bar
Max Temp 100°C

Part No.	Hose Ø	Price
775 202	6mm	£0.64
775 212	8mm	£0.88
775 230	10mm	£0.92
775 232	12mm	£0.96

PLASTIC ELBOW



Elbow Connector
Max Pressure 14 Bar
Max Temp 100°C

Part No.	Hose Ø	Price
775 203	6mm	£0.76
775 213	8mm	£0.76
775 223	10mm	£0.92
775 233	12mm	£0.96

Hydrant & Standpipe Fittings

MALE TO HOSE TAIL



2.1/2" Male Half Instantaneous Coupling to Hose Tail
Aluminium Unpolished

Part No.	Hose Tail	Price
070 002	1.1/2"	£23.70
070 003	2"	£25.35
070 004	2.1/2"	£26.87
070 005	3"	£81.20

MALE TO FEMALE ADAPTOR



Male Half Instantaneous Coupling to 1" BSP Female
Aluminium Unpolished

Part No.	Price
070 010	£75.87

FEMALE TO MALE ADAPTOR



2.1/2" Female Half Instantaneous Coupling to 2" BSP Male Threaded
Aluminium Unpolished

Part No.	Price
070 006	£140.60

FEMALE TO MALE HOSE TAIL

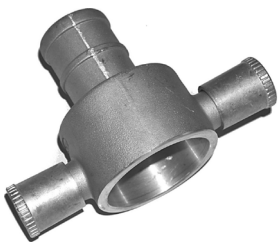

Female 2.1/2" Instantaneous Couplings Hose Tail
Aluminium Unpolished

Part No.	Price
070 102	£50.43

SINGLE HYDRANT - HRT BASE



Single Swivel Head Hydrant - Brigade Type with HRT Base

Head
2.1/2" Female Instantaneous Coupling

Base
2.1/2" Hydrant Round Thread (BS750)

Part No.	Price
070 001	£294.50

CONTRACTORS STANDPIPE



For temporary water supplies on building sites. Fitted with a brass 3/4" Hose Union Bib tap to BS1010. Also fitted with a brass Double Check Valve to BS6282. WRC (Water Research Council) approved.

Hydrant Base is 2.1/2" London Pattern which will suit all areas of the UK except Milton Keynes and Belfast.
Hydrant overall height is 1.08m

Part No.	Price
200 170	£69.88

HYDRANT KEY



1.3/4" AF Head
42" handle length

Part No.	Price
200 181	£17.90

STOP COCK KEY - 12MM BOX

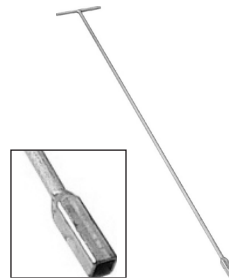

Manufactured from 10mm dia steel bar, with welded handle and key heads

Zinc, clear passivated finish
Overall Length 1065mm
12mm Box Head

Part No.	Price
200 179	£11.50

STOP TAP - CHANNEL HEAD

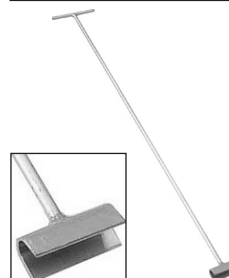

Manufactured from 10mm dia steel bar, with welded handle and key heads

Zinc, clear passivated finish
Overall Length 1065mm
12mm Channel Head

Part No.	Price
200 178	£12.67

Midi Cobra Rodding System



Midi Cobra Rodding System

The 'Midi Cobra' rodding system gives a compact and labour saving solution whether installing cables in ducts, threading draw ropes through pipes or surveying drains with CCTV cameras.

Dimensions - 655mm width x 680mm height
x 245mm depth
6mm fibreglass rod
Cable length - 50 Metre

Part No.	Net Price
782 300	£242.60

Cobra Rodding Cable 6mm x 50 Metre	Brake Handle	Flexi Spring Tip	Stainless Steel D Shackle for 4.5/6mm Rod
782 317 £125.80	782 315 £18.05	782 316 £38.65	782 313 £4.20
Sonde Adaptor for 4.5mm / 6mm Rod	6mm Rod Repair Splice	End Fitting for 6mm Rod	Brass Rod Guide Tip 4.5mm / 6mm
782 309 £9.75	782 307 £9.20	782 306 £8.92	782 305 £11.70
Guiding Eye for Cable	Guiding Eye Complete w/ Nut	Roller Guide Tip 4.5 mm / 6mm	Cobra Nylon Eye Insert for Cable Duct Rodding System
782 310 £10.80	782 312 £11.12	782 318 £36.05	782 311 £3.50

Drainage Equipment

DRAIN ROD SETS



Set comprises:
10 Rods (30ft total), 4" Plunger,
Double Worm Screw & Drop Scraper

Packed in a strong polypropylene
case c/w instructions

Part No.	Type	Price
DR47011	3/4" Universal (Screw On)	£39.87
DR47012	3/4" Lock Fast	£55.63

5" RUBBER SINK PLUNGER



Rubber Sink Plunger with Wooden Handle.
5" Suction Cup.
16" Wooden Handle.

Part No.	Price
804 950	£3.82

DRAIN RODS



Polypropylene Drain Rods
3ft x 3/4"

Part No.	Type	Price
DR10311	3/4" Universal (Screw On)	£1.75
DR11012	3/4" Lock Fast	£3.93
DR47031	Plastic Drain Rod Case	£19.18

WORM SCREWS



Double Worm Screw
Zinc Passivated Steel

Part No.	Type	Price
DR42011	Screw On	£2.83
DR42012	Lock Fast	£3.08

RUBBER PLUNGERS



Rubber Plungers 4" & 6"

Part No.	Size	Type	Price
DR41011	4"	Screw On	£2.40
DR41012	4"	Lock Fast	£2.56
DR41021	6"	Screw On	£3.18
DR41022	6"	Lock Fast	£3.57

DROP SCRAPERS



Drop Scraper 4" & 6"
Zinc Passivated Steel

Part No.	Size	Type	Price
DR44011	4"	Screw On	£2.69
DR44012	4"	Lock Fast	£2.77
DR44021	6"	Screw On	£2.92
DR44022	6"	Lock Fast	£3.33

WIFI ENDOSCOPE CAMERA



Waterproof Wi-Fi Endoscope
Length: 3.5m
Rechargeable
Flexible, semi-rigid cable
Compatible with Android and IOS
Six adjustable LED lights

Part No.	Price
902 1000	£31.65

STEEL MANHOLE LIFTING KEYS



Fabricated from 15mm diam
steel bar with welded key

Zinc plated to 90 hours salt spray
test

Part No.	Size	Price
200 175	150mm	£8.86
200 176	300mm	£9.69
200 177	600mm	£16.44

Drainage Equipment

PVC DRAIN BRUSHES



PVC Drain Brush 4" & 6"

Part No.	Size	Type	Price
DR53011	4"	Screw On	£4.58
DR53012	4"	Lock Fast	£5.45
DR53021	6"	Screw On	£4.65
DR53022	6"	Lock Fast	£5.57
DR53081	16"	Chimney Sweep Brush Screw On	£8.50

STEEL DRAIN TEST PLUGS



Thrust washers fitted as standard on all sizes. Zinc plated – corrosion resistant to 90 hours salt spray test. Combines the economy of price with the strength of steel.

Larger Sizes Available.

Part No.	Type	Outlet	Price
200 497	3" (75mm)	1/2"	£5.48
200 498	4" (100mm)	1/2"	£4.40
200 499	6" (150mm)	1/2"	£6.25
200 938	9" (230mm)	1"	£19.45
200 936	10" (255mm)	1"	£27.62
200 937	12" (300mm)	1"	£33.87

CLEARING WHEELS



Brass Clearing Wheel

Part No.	Type	Price
DR43011	Screw On	£3.95
DR43012	Lock Fast	£4.10

NYLON DRAIN TEST PLUGS



Can be used for testing up to 7 psi
Designed to fit Telecommunication Ducts for temporary sealing to prevent ingress of vermin and sand.
Easy to sterilise so can be used in Hospitals, Food Processing Plants etc.

Part No.	Type	Outlet	Price
200 500	3" (75mm)	1/2"	£4.33
200 501	4" (100mm)	1/2"	£3.93
200 502	6" (150mm)	1/2"	£5.43

DRAIN TESTING KITS



Suitable for pressure testing drains and sewers to BS.8005 and EN1610

Part No.	Type	Price
DR79109	Test Kit - Nipples Only	£30.75
DR79119	Test Kit c/w 2 x 4" Plugs	£38.23
DR79191	Drain Tracing Dye - 200g	£10.20

ALUMINIUM DRAIN TEST PLUGS



Aluminium plates combine strength with lightness

Thrust washers fitted as standard on all sizes

Part No.	Type	Outlet	Price
200 503	3" (75mm)	1/2"	£5.37
200 504	4" (100mm)	1/2"	£5.60
200 505	6" (150mm)	1/2"	£8.87

CANVAS AIR BAGS



Can be fitted with a Schrader valve or brass air tap

Ideal for use in areas where access is smaller than the test diameter

Part No.	Type	Price
200 917	4" Canvas Drain Bag	£19.30
200 918	6" Canvas Drain Bag	£21.35
200 919	Air Bag Pump	£24.22

BLANKING CAPS



Blanking caps & testing nipples for drain plugs

Part No.	Type	Size	Price
DR79025	Blanking Cap	1/2"	£1.10
DR79026	Blanking Cap	1"	£1.56
DR79031	Nipple Adaptor	1/2"	£1.14
DR79032	Nipple Adaptor	1"	£1.65

Pressure Washer Spares

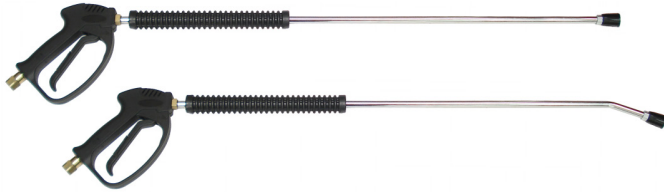

Gun & Lance Assemblies

Kits include gun, 900mm lance & size 050/15° spray nozzle
3/8" BSP Inlet
1/4" BSP Outlet

Part No.	Lance	Pressure	Temp	Flow Rate	Price
300 5030	Straight	280 bar	150°C	25 ltr/min	£28.00
300 5040	Angled	280 bar	150°C	25 ltr/min	£24.95

HIGH PRESSURE HOSES



3/8" BSP female/female ends
Length: 30ft
Hose O/D: 5/16
Temp: 150°C

Part No.	Pressure	Price
300 5060	200 bar	£39.90
300 5070	400 bar	£49.00

SIDE HANDLE



Side handle fits most pressure washer lances

Part No.	Price
300 5222	£9.38

KARCHER HOSES



Replacement hoses suitable for Karcher pressure washers

Length: 30ft
Pressure: 200 bar
Temp: 150°C

Part No.	Fittings	Price
410 517	SW2 x M22 Female	£45.41
410 516	SW4 x M22 Female	£57.22

GUN ONLY



Trigger Handle Only

280 Bar pressure rating
3/8" BSP Female Inlet
1/4" BSP Female Outlet

Part No.	Price
300 500	£22.55

LANCE ONLY



Stainless Steel Lance Only

Length: 900mm
1/4" BSP Thread

Part No.	Price
300 510	£13.15

KARCHER ADAPTORS

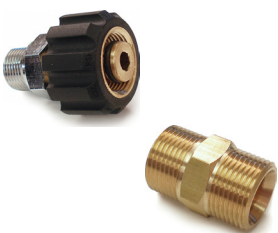

High pressure adaptors to suit Karcher pressure washers

Part No.	Size	Price
300 530	3/8" BSP Male to M22 Female	£6.60
300 531	3/8" BSP Female to M22 Female	£8.60
300 532	M22 Male/Male Hose Joiner	£6.13
300 534	M22 Male/Female Hose Joiner	£5.90

HEAVY DUTY WASH DOWN GUN



Heavy Duty Pressure Wash Down Gun
Adjustable Spray Nozzle
1/2" BSP inlet
Max Pressure: 25 bar/360psi
Not suitable for use with steam

Part No.	Price
300 6700	£37.17

Pressure Washer Spares

OPTI-KLIX COUPLING SET



Premium Quality Coupling Set
Includes 3/8" BSP coupling half
& 3/8" BSP plug half

Interchangeable with TEMA
fittings

Part No.	Price
300 509	£13.82

EQUAL M/M ADAPTORS



Male/Male BSP Adaptors

Part No.	Size	Price
965 380	3/8" x 3/8" BSP	£1.48
965 120	1/2" x 1/2" BSP	£1.65
965 340	3/4" x 3/4" BSP	£2.55
965 101	1" x 1" BSP	£7.10

M/F SWIVEL ADAPTORS



Male/Female BSP Swivel
Adaptors

Suitable for Pressure Washers &
Hydraulic Power Packs

Part No.	Male	Female	Price
300 580	1/4" BSP	1/4" BSP	£2.10
300 581	3/8" BSP	3/8" BSP	£2.17
300 582	1/2" BSP	1/2" BSP	£4.38
300 583	3/4" BSP	3/4" BSP	£3.99
300 584	1" BSP	1" BSP	£6.59

MALE/MALE REDUCERS



Male/Male BSP Adaptors

Part No.	Size	Price
965 350	1/2" x 3/8" BSP	£2.44
965 360	3/4" x 1/2" BSP	£2.55

INTERPUMP WATER SEAL KITS



Water Seal Kits for Interpump
Series 44 & 47 Water Pumps

Other kits available - please
contact us

Part No.	Interpump Models	Price
300 525	W112, W124, W140, W14200, W154, W16180, W200, W204, W954, W955 W956, W957, W958, W959, W97	£49.60
300 526	W101, W131, W151, W201, W912, W913, W914, W916, W921, W922, WS101 WS102, WS131, WS133, WS151 WS152, WS201, WS202, WS82	£45.36

INTERPUMP OIL SEAL KITS



Water Seal Kits for Interpump
Series 44 & 47 Water Pumps

Other kits available - please
contact us

Part No.	Interpump Models	Price
300 523	W112, W124, W130, W140, W145200, W150W154, W16180, W170, W200, W204, W950, W951, W952, W953, W954, W955, W95, W957, W958, W959, W97, WW116, WW136 W101, W131, W132, W151, W162, W201, W912, W913, W914, W916, W92, W921	£12.82
300 524	W922, W928, WS101, WS102, WS13 WS132, WS133, WS151, WS152, WS162	£13.15



Interpump Pressure Washers

Parts are available to order for your
Interpump pressure washer

Please contact us with your model
number for a quote

Pressure Washer Spares

CHEMICAL LANCE



Double lance for chemical applications
1/4" male inlet, 2 x 1/4" female outlets
Length 1000mm

Nozzle is switched & detergent applied automatically by changing the output pressure via the adjustable knob

Part No.	Price
300 5250	£56.20

INLINE CHEMICAL INJECTOR



Brass Fixed Chemical Injector
Size 2.1

3/8" BSP Female In
3/8" BSP Male Out
6mm Hose Tail

Part No.	Price
300 5251	£13.15

CHEMICAL NOZZLE HOLDER



Pressure Reducing Nozzle Holder
1/4" BSP

Used in conjunction with Injectors for Low Pressure Chemical Applications

Part No.	Price
300 512	£11.50

INLINE SUCTION FILTER



Screw Top Type

Replaceable Mesh Filter
1/2" BSP Female Inlet
1/2" BSP Male Outlet

Part No.	Price
300 5256	£23.65

INLINE SUCTION FILTER



Clear Bowl with Replaceable Mesh Filter - 80 Micron

1/2" BSP Female In/Out

Part No.	Price
300 5255	£20.50

CHEMICAL SUCTION FILTERS



Stainless steel body, brass hose tail

Ideal for small pumps and pressure washers

Part No.	Basket Ø	Hose Tail	Price
413 101	17mm	6mm	£6.90
413 102	35mm	1/2"	£9.84
413 103	35mm	3/4"	£7.60

STANDARD NOZZLE HOLDER



Standard Fixed Nozzle Holder
1/4" BSP

Part No.	Price
300 511	£4.40

1/4" QUICK CONNECT FEMALE



Quick Connect High Pressure Nozzle Holder
1/4" BSP Female

Part No.	Price
300 513	£7.50

1/4" QUICK CONNECT MALE



Quick Connect Male Plug
1/4" BSP Male Thread.

Part No.	Price
300 514	£6.25

QUICK CONNECT NOZZLE SET



Quick Connect Nozzle Set
Size 050

0°, 15°, 25°, 40° & Soap Nozzles

Part No.	Price
370 035	£15.00

Pressure Washer Spares

High Pressure Spray Nozzles



High Pressure Spray Nozzles
1/4" BSP

Price (ea) **£4.95**

Rotary Nozzles



Rotates at high speeds to increase both the intensity and cleaning area of the spray

Ideal for cleaning large, flat surfaces such as driveways and patios
1/4" BSP Inlet Max Temp: 100°C

Spray Angle 0°		Spray Angle 15°		Spray Angle 25°		Spray Angle 40°	
Part No.	Size	Part No.	Size	Part No.	Size	Part No.	Size
T00 020	02	T15 020	02	T25 020	02	T40 020	02
T00 025	025	T15 025	025	T25 025	025	T40 025	025
T00 030	03	T15 030	03	T25 030	03	T40 030	03
T00 035	035	T15 035	035	T25 035	035	T40 035	035
T00 040	04	T15 040	04	T25 040	04	T40 040	04
T00 045	045	T15 045	045	T25 045	045	T40 045	045
T00 050	05	T15 050	05	T25 050	05	T40 050	05
T00 055	055	T15 055	055	T25 055	055	T40 055	055
T00 060	06	T15 060	06	T25 060	06	T40 060	06
T00 065	065	T15 065	065	T25 065	065	T40 065	065
T00 070	07	T15 070	07	T25 070	07	T40 070	07
T00 080	08	T15 080	08	T25 080	08	T40 080	08
T00 090	09	T15 090	09	T25 090	09	T40 090	09

V-TUF Turbo Nozzles Max. 3700psi (255 bar)			Heavy Duty Max. 5076psi (350 bar)		
Part No.	Size	Price	Part No.	Size	Price
TNS030	03	£38.32	TNH030	03	£49.17
TNS040	04	£38.32	TNH040	04	£47.54
TNS045	045	£38.32	TNH045	045	£47.54
TNS050	05	£43.99	TNH050	05	£45.81
TNS055	055	£43.99	TNH055	055	£45.81
TNS060	06	£38.32	TNH060	06	£47.54
TNS070	07	£38.32	TNH065	065	£47.54

Choosing a suitable nozzle

Pressure in bar		Key: Nozzle Flow (ltr/min) Diameter																				
		30	40	50	60	70	80	90	100	110	120	130	140	150	160	175	200	225	250	300	400	500
02	1,00	2,5	2,8	3,2	3,5	3,7	4,0	4,2	4,5	4,7	4,8	5,0	5,3	5,4	5,6	5,9	6,3	6,7	7,0	7,7	8,9	9,9
025	1,10	3,1	3,5	4,0	4,3	4,7	5,0	5,3	5,6	5,9	6,1	6,4	6,6	6,9	7,1	7,5	8,0	8,5	9,0	9,9	11,4	12,7
03	1,18	3,7	4,3	4,8	5,3	5,7	6,1	6,3	6,8	7,1	7,4	7,7	8,0	8,3	8,6	9,0	9,6	10,2	10,7	11,8	13,5	15,1
035	1,30	4,2	4,9	5,5	6,0	6,5	7,0	7,4	7,8	8,2	8,6	8,9	9,2	9,5	9,8	10,3	11,0	11,7	12,3	13,8	15,5	17,8
04	1,35	5,2	5,9	6,6	7,3	7,8	8,4	8,9	9,4	9,8	10,3	10,7	11,1	11,5	11,9	12,4	13,3	14,1	14,8	16,3	18,7	20,9
045	1,40	5,5	6,4	7,1	7,8	8,4	9,0	9,6	10,2	10,5	10,9	11,4	11,8	12,2	12,6	13,2	14,1	15,0	15,8	17,4	19,9	22,3
05	1,55	6,2	7,1	8,0	8,7	9,4	10,0	10,7	11,3	11,8	12,4	12,9	13,4	13,8	14,3	14,9	16,0	16,9	17,9	19,7	22,6	25,3
055	1,60	6,8	7,8	8,7	9,6	10,3	11,1	11,8	12,4	13,0	13,6	14,1	14,7	15,2	15,7	16,4	17,5	18,6	19,6	21,7	25,0	28,0
06	1,72	7,4	8,6	9,6	10,4	11,3	12,1	12,8	13,6	14,3	14,9	15,5	16,0	16,7	17,2	18,0	19,2	20,4	21,5	23,7	27,1	30,3
065	1,75	8,0	9,3	10,4	11,3	12,3	13,2	14,0	14,7	15,4	16,1	16,8	17,4	18,0	18,6	19,4	20,8	22,0	23,2	25,6	29,3	32,7
07	1,80	8,6	10,0	11,2	12,2	13,2	14,1	15,0	15,8	16,6	17,3	18,0	18,7	19,3	20,0	20,9	22,3	23,7	25,0	27,1	31,3	35,0
075	1,90	9,3	10,7	12,0	13,1	14,2	15,2	16,1	16,9	17,7	18,5	19,3	20,0	20,7	21,4	22,4	23,9	25,3	26,7	29,4	33,7	37,7
08	2,05	9,8	11,3	12,7	14,0	15,1	16,1	17,1	18,0	18,9	19,7	20,5	21,3	22,0	22,8	23,8	25,5	27,0	28,5	31,4	35,9	40,2
085	2,08	10,4	12,1	13,5	14,8	16,0	17,1	18,1	19,1	20,0	20,9	21,8	22,6	23,4	24,1	25,3	27,0	28,6	30,2	34,5	39,8	44,5
09	2,10	11,1	12,8	14,3	15,7	17,0	18,0	19,2	20,2	21,2	22,1	23,0	23,9	24,7	25,5	26,7	28,6	30,3	31,9	35,1	40,2	45,0

1. Pressure and flow rate of the pressure washer must be known e.g. a flow of 15 l/min - working pressure of 150 bar.
2. In the first line (pressure in bar) go to column '150'.
3. Follow column '150' down to find ltr/min closest to '15' i.e. '15.2'
4. Trace left of '15.2' until nozzle type '055' is reached.
5. The nozzle size required is '055'.

STIHL® For STIHL Pressure Washer Spares - Please Contact Us

B - Hose, Pumps & Fittings

Workshop Air Line Hoses

RECOILED AIR LINE HOSE



Recoiled Nylon Air Line
Spring Ends with 1/4" BSP
Swivel Nuts

25ft Working Length

Part No.	Price
805 103	£26.25

RUBBER AIR LINE HOSE



Rubber Air Line Hoses
20 bar

Part No.	Bore Size	Coil Length	Price
805 197	1/4" (6mm)	20m	£27.47
805 196	5/16" (8mm)	20m	£30.21
124 0234	3/8" (10mm)	20m	£34.63
805 190	1/2" (13mm)	20m	£49.00

RUBBER AIR LINE C/W NUTS



Rubber Air Line Hoses with
BSP Swivel Nuts
300 psi

Part No.	Bore	Nut	Length	Price
805 311	1/4" (6mm)	1/4" BSP	10m	£23.52
805 312	5/16" (8mm)	1/4" BSP	10m	£28.02
805 313	3/8" (10mm)	3/8" BSP	10m	£32.17

OVERBRAIDED AIR LINE HOSE



Overbraided Air Line Hoses
with 1/4" BSP Swivel Nuts
Black PVC
300 psi

Part No.	Bore	Nut	Length	Price
805 101	5/16" (8mm)	1/4" BSP	10m	£23.40
805 102	5/16" (8mm)	1/4" BSP	20m	£37.62

O CLIPS



Zinc Plated

Part No.	I/D	Range	Price (ea)
505 150	1/4"	5 - 7mm	£0.20
505 151	5/16"	7 - 9mm	£0.21
505 138	3/8"	8 - 11mm	£0.17
505 139	7/16"	9 - 11mm	£0.17
505 140	1/2"	11 - 13mm	£0.23
505 141	9/16"	13 - 15mm	£0.20
505 142	5/8"	15 - 18mm	£0.25
505 146	3/4"	17 - 20mm	£0.24
505 147	7/8"	20 - 23mm	£0.40
505 148	1"	23 - 27mm	£0.60
105 159	Assorted Box - 125 Clips Sizes: 3/8" - 7/8"		£21.88

PIPE JOINERS



Zinc Plated

Part No.	Bore Size	Price (ea)	
625 147	1/4" (6mm)	£0.78	
625 148	5/16" (8mm)	£0.93	
625 149	3/8" (10mm)	£0.93	
625 150	1/2" (13mm)	£0.90	
625 151	5/8" (16mm)	£1.08	
105 168	Assorted Box of O Clips & Joiners - 72 Pieces		£29.73

O CLIP PLIERS



Plastic Coated Handles
Side Closing Type

Part No.	Price
505 145	£33.17

1/4" PCL Couplings

PCL COUPLING TO 1/4" FEMALE



PCL AIRFLOW Coupling to 1/4" BSP Female (Parallel) Thread

Compatible with Standard Adaptors

Part No.	Price
805 104	£5.30

PCL TWIN 'Y' COUPLING



PCL AIRFLOW Twin Couplings to STANDARD Male Adaptor

Fits PCL STANDARD Male Adaptor For Producing Two Supplies from a Single Source

Part No.	Price
805 107	£19.73

PCL COUPLING TO 1/4" MALE



PCL AIRFLOW Coupling to 1/4" BSP Male (Taper) Thread

Fits PCL STANDARD Male Adaptor

Part No.	Price
805 118	£5.48

1/4" MALE/MALE ADAPTOR



PCL Male/Male Adaptor

1/4" BSP (Parallel) Thread

Part No.	Price
805 112	£1.30

STANDARD ADAPTOR TO TAIL



PCL STANDARD Adaptor to Hose Tail

For use with AIRFLOW & VERTEX Quick Release Couplings

Part No.	Hose Tail	Price
805 110	1/4" (6mm)	£1.01
805 126	5/16" (8mm)	£1.26
805 120	3/8" (10mm)	£0.93

1/4" BSP MALE TO HOSE TAIL



PCL Screwed Tailpiece 1/4" BSP Male Thread

Part No.	Hose Tail	Price
805 111	1/4" (6mm)	£1.17
805 127	5/16" (8mm)	£0.98
805 122	3/8" (10mm)	£1.22
805 139	1/2" (13mm)	£1.28

1/2" MALE TO 1/4" MALE



PCL Male/Male Reducing Union

1/2" x 1/4" BSP (Taper) Thread

Part No.	Price
805 154	£2.13

STD ADAPTOR TO 1/4" MALE



PCL STANDARD Adaptor to 1/4" BSP Male (Taper) Thread

For use with AIRFLOW & VERTEX Couplings

Part No.	Price
805 108	£1.10

STD ADAPTOR TO 1/4" FEMALE



PCL STANDARD Adaptor to 1/4" BSP Female (Parallel) Thread

For use with AIRFLOW & VERTEX Couplings

Part No.	Price
805 109	£1.12

Prevost Quick Release Safety Couplings



Prevost Blowgun & Hose Kit

Prevost Safety Fittings are designed to prevent kickback when de-coupling tools and meet current safety regulations to BSI 06
Compatible with standard PCL systems

Hose extends to 4m
Hose Diam: 6.5mm

Pressure: 12 bar
Flow rate at 6 bar: 750 l/min



Part No.	Price
737 0010	£97.90

QUICK RELEASE - 1/4 FEMALE



Quick Release Safety Coupling
To 1/4" BSP Female

Compatible with PCL Standard
Fittings

Part No.	Price
737 0001	£24.17

QUICK RELEASE - 1/4 MALE



Quick Release Safety Coupling
To 1/4" BSP Male

Compatible with PCL Standard
Fittings

Part No.	Price
737 0002	£23.04

QUICK RELEASE - HOSE TAIL



Quick Release Safety Coupling
To 8mm Hose Tail

Compatible with PCL Standard
Fittings

Part No.	Price
737 0016	£25.12

STANDARD PLUG - MALE



Standard Male Adaptor
To 1/4" BSP Male

Compatible with PCL Standard
Fittings

Part No.	Price
737 0012	£2.75

STANDARD PLUG - FEMALE



Standard Male Adaptor
to 1/4" BSP Female

Compatible with PCL Standard
Fittings

Part No.	Price
737 0013	£2.10

EURO QUICK RELEASE FEMALE



Euro (XF) Quick Release Coupling
To 3/8" BSP Female

Part No.	Price
737 0006	£21.50

EURO QUICK RELEASE - MALE



Euro (XF) Quick Release Coupling
To 3/8" BSP Male

Part No.	Price
737 0007	£31.23

EURO PLUG - 8MM HOSE TAIL



Euro Plug
To 8mm Hose Tail

Part No.	Price
737 0017	£2.30

EURO PLUG - 3/8 MALE



Euro Plug
To 3/8" BSP Tapered Male

Part No.	Price
737 0014	£2.84

EURO PLUG - 3/8" FEMALE



Euro Plug
To 3/8" BSP Tapered Female

Part No.	Price
737 0011	£3.45

Air Tools

1" Impact Wrench



A powerful heavy duty 1" Impact Wrench with 3 forward power settings.
Maximum Torque 2440 Nm – powerful heavy duty wrench
Twin hammer mechanism
200mm extended shank
Rear exhaust through handle
Side handle for comfortable grip



Part No.	Price
985 526	NLA

1/2" IMPACT WRENCH



1/2" Impact Wrench
1/2" Drive
Max Torque 540Nm
90psi (6.2 bar)



Part No.	Price
985 521	£114.00

3/8" REV. AIR DRILL



3/8" Reversible Air Drill
Chuck Size: 3/8" (10mm).
Free Speed 2500 RPM



Part No.	Price
985 523	£68.37

PCL MK4 AIR LINE GAUGE



Dual Calibrated 0 - 138lbf/in2
& 0 - 9.6 bar
1/4" Female Connector



Part No.	Price
805 129	£78.00

DIE GRINDER 6MM COLLET



High free speed 22,000 rpm
Safety throttle lever
Rear exhaust through handle
High velocity, low vibration



Part No.	Price
985 524	£36.05

AIR ENGRAVER



Tungsten Carbide Tip for
Engraving Metals & Plastics
Complete with 4ft Air Line
1/4" BSP Female Nut

Part No.	Description	Price
902 2265	Air Engraver	£137.40
902 2266	Replacement Tip	£26.77

PISTOL GRIP BLOW GUN



PCL Pistol Grip Blow Gun
Moulded Special Acetalyc
Resin To Resist Damage.
For use with Air & Water

Max Pressure: 18 bar



Part No.	Price
902 2281	£8.10

PISTOL GRIP BLOW GUN



5 Piece Air Tool Kit
1 x Tyre inflator with pressure gauge
1 x Blow out gun
1 x Spiral air hose with quick coupling
1 x Oil spray gun with suction cup
1 x Paint spray gun with gravity cup

Part No.	Price
902 2270	£36.00

PCL BLOW GUN



PCL Blowgun with Safety
Nozzle
Die Cast Alloy
1/4" Inlet

Outlet Pressure: 28 psi



Part No.	Price
902 2280	£13.49

Air Tools

Full range of workshop air tools available to order. Please contact us with your requirements.

Workshop Air Tools

HEAVY DUTY AIR LINE GAUGE



PCL Airforce Heavy Duty MK4 Tyre Inflator
Can Inflate up to 174 psi (12 bar)

Hose Length: 3.6m / 12ft
Valve Connection: Twin Clip-on
Calibration: 0-174 psi / 0-12 bar

TYRE INFLATOR



Economy Tyre Inflator - Dial Type
Fast Inflation/Deflation Rates,
Shock Resistance & Clear Dial
Display

Max. Inflation Pressure of 12 Bar,
Resolution 0.1 Bar, Inflation Flow
910 l/min@13 Bar Supply &
Operating Temperature: -20 to 60°C

Part No.	Price	Part No.	Price
AFG5H36	£121.60	805 194	£67.85

Tyre Pressure Gauge Twin Hold-On (Open End) Dual Calibrated 0-12 bar	Economy Tyre Inflator c/w 0.5m of Air Hose Dual Calibrated 0-12 bar	PCL Digital Tyre Pressure (>100psi) & Depth Gauge Self Calibrating	PCL Tyre Valve Connector Twin Hold-On Type (Open End)
805 189 £40.22	805 192 £40.30	805 315 £22.18	805 115 £10.18
PCL Tyre Valve Connector Twin Clip-On Type (Open End)	PCL Tyre Valve Connector Single Clip-On (Open End) 6.35mm (1/4") Tail	Tyre Pressure Gauge Dual Calibrated 10 - 120lbf/in2 & 0.8 - 8.2 bar	Pocket Tyre Pressure Gauge Dual Calibrated 6 - 50lbf/in2 & 0.5 - 3.4 bar
805 128 £32.83	805 114 £11.57	805 160 £18.70	805 187 £13.42
Universal Tyre Pressure Gauge. Dual Calibrated 10 - 160lbf/in2 & 0.8 - 11.0 bar	PCL Tyre Tread Gauge Size: 1-6mm	Tyre Valve Tool Re-Threads, Removes & Extracts Damaged Cores	PCL Blowgun with Conical & Safety Nozzle, Max Supply 140psi, Airflow 240 l/min / 8.9cfm
805 188 £59.49	805 119 £4.38	805 134 £4.85	BG605 £7.13

Strops & Roundslings

POLYESTER LIFTING STROPS

Colour Coded, Duplex Webbing Slings with Reinforced Eyes
100% Polyester, Conforms to BS3481; Part 2; 1983, Safety Factor 7:1
Supplied with Test Certificate

Part No.	Colour	Width	Length	Price		
Working Load Limit (WLL) 1 Tonne						
STROP 1T 1M	VIOLET	30mm	1M	£3.60		
STROP 1T 2M			2M	£5.90		
STROP 1T 3M			3M	£5.72		
STROP 1T 4M			4M	£7.15		
STROP 1T 5M			5M	£8.96		
STROP 1T 6M			6M	£9.60		
STROP 1T 8M			8M	£11.50		
STROP 1T 10M			10M	£39.00		
STROP 1T 12M			12M	£48.90		
Working Load Limit (WLL) 2 Tonne						
STROP 2T 1M			GREEN	60mm	1M	£4.74
STROP 2T 2M					2M	£9.50
STROP 2T 3M	3M	£12.05				
STROP 2T 4M	4M	£15.90				
STROP 2T 5M	5M	£21.00				
STROP 2T 6M	6M	£21.70				
STROP 2T 8M	8M	£26.95				
STROP 2T 10M	10M	£33.10				
STROP 2T 12M	12M	£43.60				
Working Load Limit (WLL) 3 Tonne						
STROP 3T 1M	YELLOW	90mm			1M	£6.40
STROP 3T 2M					2M	£10.90
STROP 3T 3M			3M	£19.00		
STROP 3T 4M			4M	£25.00		
STROP 3T 5M			5M	£25.06		
STROP 3T 6M			6M	£30.50		
STROP 3T 8M			8M	£42.08		
STROP 3T 10M			10M	£37.70		
STROP 3T 12M			12M	£59.40		

Working Load Limit (WLL) 4 Tonne							
STROP 4T 1M	GREY	120mm	1M	£9.40			
STROP 4T 2M			2M	£14.45			
STROP 4T 3M			3M	£20.72			
STROP 4T 4M			4M	£27.30			
STROP 4T 5M			5M	£32.50			
STROP 4T 6M			6M	£44.88			
STROP 4T 8M			8M	£39.00			
STROP 4T 10M			10M	£49.00			
STROP 4T 12M			12M	£89.30			
Working Load Limit (WLL) 5 Tonne							
STROP 5T 2M			RED	150mm	2M	£22.00	
STROP 5T 3M					3M	£28.75	
STROP 5T 4M	4M	£33.58					
STROP 5T 5M	5M	£54.24					
STROP 5T 6M	6M	£53.80					
STROP 5T 8M	8M	£51.20					
STROP 5T 10M	10M	£80.68					
STROP 5T 12M	12M	£98.70					
Working Load Limit (WLL) 6 Tonne							
STROP 6T 2M	BROWN	180mm			2M	£26.40	
STROP 6T 3M					3M	£33.00	
STROP 6T 4M					4M	£34.00	
STROP 6T 5M			5M	£43.00			
STROP 6T 6M			6M	£51.20			
STROP 6T 8M			8M	£58.63			
Working Load Limit (WLL) 8 Tonne							
STROP 8T 2M			BLUE	240mm	2M	£37.64	
STROP 8T 3M					3M	£42.70	
STROP 8T 4M					4M	£56.53	
STROP 8T 5M					5M	£56.88	
STROP 8T 6M					6M	£65.63	
STROP 8T 8M	8M	£79.63					



How to measure roundslings is shown above
Sling circumference (i.e 2 x length measured flat = circumference)

POLYESTER ROUNDSLINGS

Manufactured from High Quality, Durable Polyester Fibres - Light in Weight & Extremely Durable. Ideal for lifting Cylindrical Objects.
Conforms to BS6668 Part II, Complies with Supply of Machinery (Safety) Regulations 1992, Safety Factor 7:1. Striped with WLL.
Supplied with Test Certificate.

Working Load Limit (WLL) 1 Tonne					Working Load Limit (WLL) 3 Tonne					Working Load Limit (WLL) 5 Tonne										
ROUND 1T 1M	VIOLET	30mm	1M	£3.25	ROUND 3T 1M	YELLOW	90mm	1M	£5.02	ROUND 5T 2M	RED	150mm	2M	£9.48						
ROUND 1T 2M			2M	£3.52	ROUND 3T 2M			2M	£6.63	ROUND 5T 3M			3M	£14.50						
ROUND 1T 3M			3M	£4.48	ROUND 3T 3M			3M	£11.00	ROUND 5T 4M			4M	£20.50						
ROUND 1T 4M			4M	£4.94	ROUND 3T 4M			4M	£12.50	ROUND 5T 5M			5M	£36.14						
ROUND 1T 5M			5M	£6.45	ROUND 3T 5M			5M	£15.00	ROUND 5T 6M			6M	£29.00						
ROUND 1T 6M			6M	£7.30	ROUND 3T 6M			6M	£18.00	ROUND 5T 8M			8M	£30.00						
ROUND 1T 8M			8M	£9.80	ROUND 3T 8M			8M	£20.00	ROUND 5T 10M			10M	£36.14						
ROUND 1T 10M			10M	£14.50	ROUND 3T 10M			10M	£29.00	ROUND 5T 12M			12M	£45.50						
ROUND 1T 12M			12M	£14.00	ROUND 3T 12M			12M	£27.76	Working Load Limit (WLL) 6 Tonne										
Working Load Limit (WLL) 2 Tonne					Working Load Limit (WLL) 4 Tonne					Working Load Limit (WLL) 8 Tonne										
ROUND 2T 1M			GREEN	60mm	1M			£3.86	ROUND 4T 2M	GREY			180mm	2M	£9.65	ROUND 6T 4M	BROWN	240mm	4M	£20.50
ROUND 2T 2M					2M			£4.48	ROUND 4T 3M					3M	£19.56	ROUND 6T 6M			6M	£34.00
ROUND 2T 3M	3M	£7.00			ROUND 4T 4M	4M	£16.50	ROUND 6T 8M	8M		£38.00									
ROUND 2T 4M	4M	£8.60			ROUND 4T 5M	5M	£30.18	ROUND 6T 10M	10M		£47.50									
ROUND 2T 5M	5M	£10.00			ROUND 4T 6M	6M	£25.00	ROUND 6T 12M	12M		£57.00									
ROUND 2T 6M	6M	£12.00			ROUND 4T 8M	8M	£28.00	Working Load Limit (WLL) 10 Tonne												
ROUND 2T 8M	8M	£15.50			ROUND 4T 10M	10M	£31.50	ROUND 8T 4M	BLUE		4M	£28.00								
ROUND 2T 10M	10M	£17.50			ROUND 4T 12M	12M	£37.50	ROUND 8T 5M			5M	£40.00								
ROUND 2T 12M	12M	£22.50									ROUND 8T 6M	6M		£38.50						
											ROUND 8T 8M	8M		£52.18						
											ROUND 8T 10M	10M		£62.00						

WEAR SLEEVES



Length: 500mm

Part No.	Size	Price
297 001	1 Ton	£5.60
297 002	2 Ton	£7.77
297 003	3 Ton	£10.42
297 004	4 Ton	£15.02

Safe Lifting Chart - Webbing Slings & Roundslings						
Working Load Limit (WLL) in Kg - Safety Factor 7:1						
	Straight Lift	Choke Lift	Basket Hitch	45° Hitch	90° Hitch	120° Hitch
VIOLET	1000kg	800kg	2000kg	1800kg	1400kg	1000kg
GREEN	2000kg	1600kg	4000kg	3600kg	2800kg	2000kg
YELLOW	3000kg	2400kg	6000kg	5400kg	4200kg	3000kg
GREY	4000kg	3200kg	8000kg	7200kg	5600kg	4000kg
RED	5000kg	4000kg	10000kg	9000kg	7000kg	5000kg
BROWN	6000kg	4800kg	12000kg	10800kg	8400kg	6000kg
BLUE	8000kg	6400kg	16000kg	14400kg	11200kg	8000kg
ORANGE	12000kg	9600kg	24000kg	21000kg	16800kg	12000kg

Wire Rope

WIRE ROPE

Available in 30m & 100m rolls

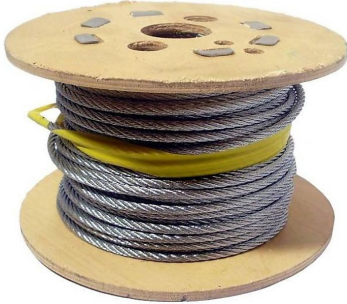

Wire Rope 6 x 7
Applications: Standing rigging
Galvanized



Wire Rope 6 x 19
6 x (1+6+12)
Applications: Running rigging
Galvanized

Part No.	Type	Rope Dia.	Breaking Strength	Roll	Price
492 260	6 x 7	2mm	2.35 KN	30m	£7.72
492 261				100m	£18.88
492 262		3mm	5.29 KN	30m	£10.00
492 263				100m	£30.00
492 264		4mm	9.40 KN	30m	£19.08
492 265				100m	£60.00
492 266		5mm	14.70 KN	30m	£31.80
492 267				100m	£96.00
492 268		6mm	21.20 KN	30m	£40.00
492 269				100m	£113.34
492 270	6 x 19	8mm	37.60 KN	30m	£22.26
492 271				100m	£73.50
492 272		10mm	52.80 KN	30m	£42.50
492 273				100m	£181.10
492 274		12mm	78.10 KN	30m	£82.00
492 275				100m	£142.50
492 276		13mm	91.70 KN	30m	£136.25
492 277				100m	£356.30
492 278	16mm	139.20 KN	30m	£150.87	
492 279			100m	£447.01	

GRADE 80 TESTED LIFTING CHAIN



Grade 80 Chain to BS-EN818
Grade 80 Tested Chain is recommended when using ratchet loadbinders or when securing heavy plant as well as lifting applications.

Supplied with Test Certificate.

Part No.	Diameter	W.L.L.	Weight per metre	Length	Price
TC/7	7mm	1500kg	1.1kg	1m	£6.10
917 002				2m	£18.39
917 003				3m	£19.02
917 004				4m	£27.82
917 005				5m	£31.70
917 006				6m	£36.60
917 007				7m	£44.38
917 008				8m	£55.36
917 009				9m	£55.98
917 010				10m	£69.20
TC/10	10mm	3150kg	2.2kg	1m	POA
910 002				2m	£19.40
910 003				3m	£29.10
910 004				4m	£46.64
910 005				5m	£55.00
910 006				6m	£66.00
910 007				7m	£70.56
910 008				8m	£77.60
910 009				9m	£90.72
910 010				10m	£91.60
TC/13	13mm	5300kg	3.8kg	1m	NLA

BARREL CHAIN SLING



Grade 80 Chain Sling suitable for Lifting 45 Gallon Barrels

Supplied with Test Certificate

Part No.	Price
492 100	£98.00

WHEELBARROW SLING



3 Leg Wheelbarrow Sling
S.W.L. 250kg

Supplied with Test Certificate

Part No.	Price
200 168	£141.70

Chain Slings

Grade 80 Chain Slings

Manufactured with Grade 80 chain and components
Never exceed the Working Load Limit

Supplied with Test Certificate

Also available fitted with C Hooks or Swivel Hooks,
with Shortening Hooks or with 13mm Chain.
Please contact us for prices.



Single Leg

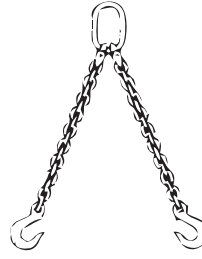

Double Leg

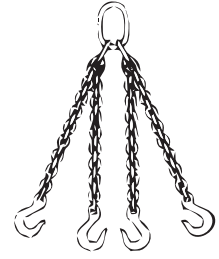

Four Leg

CHAIN SLINGS WITH SAFETY SLING HOOKS



Grade 80 Chain Slings fitted with Alloy Steel Clevis Sling Hooks with Safety Catch.

Supplied with Test Certificate

Chain Size (mm)	Sling Type	W.L.L. (Tonnes)	1 Metre		2 Metre		3 Metre		4 Metre	
			Part No.	Price	Part No.	Price	Part No.	Price	Part No.	Price
7mm	Single Leg	1.5	491 700	£45.32	492 700	£51.60	493 850	£57.90	494 850	£64.20
	Double Leg	2.12	491 710	£79.10	492 710	£90.90	493 851	£92.20	494 851	£103.70
	Four Leg	3.15	491 820	£144.20	492 820	£144.20	493 852	£167.10	494 852	£174.10
10mm	Single Leg	3.15	491 800	£79.30	492 800	£71.00	493 855	£80.44	494 855	£89.88
	Double Leg	4.25	491 810	£95.20	492 810	£112.50	493 856	£129.50	494 856	£146.70
	Four Leg	6.7	491 821	£172.70	492 821	£206.10	493 857	£239.40	494 857	£298.50

CHAIN SLINGS WITH SELF LOCKING HOOKS



Grade 80 Chain Slings fitted with Alloy Steel Self Closing Clevis Sling Hooks

Supplied with Test Certificate

Chain Size (mm)	Sling Type	W.L.L. (Tonnes)	1 Metre		2 Metre		3 Metre		4 Metre	
			Part No.	Price	Part No.	Price	Part No.	Price	Part No.	Price
7mm	Single Leg	1.50	591 700	£62.43	592 700	£65.20	593 850	£71.50	594 850	£77.80
	Double Leg	2.12	591 710	£97.80	592 710	£103.70	593 851	£115.10	594 851	£126.60
	Four Leg	3.15	591 820	£173.20	592 820	£170.80	593 852	£191.80	594 852	£212.70
10mm	Single Leg	3.15	591 800	£79.48	592 800	£88.76	593 855	£98.18	594 855	£97.80
	Double Leg	4.25	591 810	£132.40	592 810	£142.10	593 856	£159.30	594 856	£176.40
	Four Leg	6.70	591 821	£236.80	592 821	£237.00	593 857	£267.80	594 857	£298.50

Grade 80 Hooks & Connectors

SLING HOOK W/ SAFETY CATCH



Alloy Steel Clevis Sling Hook with Safety Catch

For Grade 80 Chain

Part No.	For Chain	Jaw Width	Price
BSH/7	7/8mm	25mm	£7.90
BSH/10	10mm	36mm	£12.10
BSH/13	13mm	44mm	£21.66
BSH/16	16mm	46mm	£41.70

SELF LOCKING SWIVEL HOOKS



Alloy Steel Swivel Sling Hook Self Closing Type

For Grade 80 Chain

Part No.	For Chain	Jaw Width	Price
LSW/8	7/8mm	35mm	£42.18
LSW/10	10mm	45mm	£45.10
LSW/13	13mm	53mm	£81.96
LSW/16	16mm	62mm	£132.70

SELF LOCKING CLEVIS HOOKS



Alloy Steel Clevis Sling Hook Self Closing Type

For Grade 80 Chain

Part No.	For Chain	Jaw Width	Price
LSH/8	7/8mm	34mm	£23.72
LSH/10	10mm	45mm	£20.50
LSH/13	13mm	54mm	£53.02
LSH/16	16mm	63mm	£76.40

MASTER LINKS



For making up 1 or 2 leg chain slings

For Grade 80 Chain

Part No.	1 Leg (for chain)	2 Leg (for chain)	Internal Size	Price
MSL/8	7/8mm	6mm	70x120mm	£10.02
MSL/10	10mm	7/8mm	80x140mm	£10.28
MSL/13	13mm	10mm	95x160mm	£10.96
MSL/16	16mm	13mm	105x180mm	£18.62

GRAB HOOKS



Alloy Steel Clevis Grab Hooks for Lifting & Load Securing

For Grade 80 Chain

Part No.	For Chain	Jaw Width	Price
BGH/8	7/8mm	11mm	£4.34
BGH/10	10mm	13mm	£8.84
BGH/13	13mm	17mm	£15.07
BGH/16	16mm	18mm	£14.28

CLEVIS 'C' HOOKS



Alloy Steel Clevis 'C' Hooks

For Grade 80 Chain

Part No.	For Chain	Jaw Width	Price
CCH/8	7/8mm	19mm	£7.72
CCH/10	10mm	26mm	£12.82
CCH/13	13mm	34mm	£25.20
CCH/16	16mm	38mm	£46.00

COMPONENT CONNECTORS



Alloy Steel Component Connectors

For Grade 80 Chain

Part No.	For Chain	Price
200 490	7/8mm	£5.60
200 491	10mm	£7.60
200 492	13mm	£10.84
200 493	16mm	£14.48

SAFETY CATCHES



Spare Safety Catches for Grade 80 Sling Hooks

Part No.	Hook Size	Price
200 513	7/8mm	£3.70
200 514	10mm	£4.20
942 903	13mm	£5.10
942 904	16mm	£7.10

Lifting Hooks & Shackles

WELD ON HOOKS



Grade 80 Alloy Steel Weld
On Hooks with Safety Catch

Part No.	S.W.L.	Price
492 330	2 Ton	£36.75
492 331	3 Ton	£42.90
492 332	5 Ton	£59.75
492 333	8 Ton	£85.35

ALLOY STEEL D SHACKLES



Self Colour Tested
Dee Shackles

Approved to BS 3032

Part No.	S.W.L.	Jaw Width	Pin Ø	Price
200 521	0.5	3/4"	1/2"	£2.36
200 522	0.75	1.1/8"	5/8"	£2.93
200 523	1.5	1.1/4"	3/4"	£4.50
200 524	2	1.1/2"	7/8"	£7.58
200 525	3	1.3/4"	1"	£10.80
200 526	5	2.1/8"	1.1/4"	£22.04

BOW SHACKLES - SCREW PIN



Tested Lifting Bow Shackles
Screw Pin Type
Galvanised

RR-C-271B Tested

Part No.	S.W.L.	Jaw Width	Pin Ø	Price
200 637	1.00 Tons	16mm	7/16"	£1.89
200 638	1.50 Tons	18mm	1/2"	£2.17
200 639	2.00 Tons	22mm	5/8"	£2.62
200 640	3.25 Tons	26mm	3/4"	£4.42
200 641	4.75 Tons	31mm	7/8"	£6.58

PILING SHACKLES



Self Colour Tested
Dee Shackles
Long Type for Piling

Approved to BS 3032

Part No.	S.W.L.	Jaw Width	Length	Price
492 250	1 Ton	7/8"	6"	£12.08
492 251	1.5 Ton	1.1/4"	8"	£15.74
492 252	2 Ton	7/8"	8"	£22.14
492 253	3 Ton	1"	10"	£30.24
492 255	3.75 Ton	1.1/4"	10"	£34.96
492 254	5 Ton	1.1/4"	12"	£41.42

BOW SHACKLES - SAFETY PIN



Tested Lifting Bow Shackles
Safety Pin Type
Galvanised

RR-C-271B Tested

Part No.	S.W.L.	Jaw Width	Pin Ø	Price
200 642	1.00 Tons	16mm	7/16"	£2.18
200 643	1.50 Tons	18mm	1/2"	£2.42
200 644	2.00 Tons	22mm	5/8"	£3.32
200 645	3.25 Tons	26mm	3/4"	£4.74
200 646	4.75 Tons	31mm	7/8"	£7.50

TRANSPORT RINGS



Weld-on Transport Rings
Manufactured from High
Grade Alloy Steel

Part No.	S.W.L.	Length	Width	Price
200 828	1 Tonne	31mm	36mm	£27.15
200 829	2 Tonnes	36mm	42mm	£24.39
200 830	3 Tonnes	46mm	48mm	£25.00
200 831	5 Tonnes	69mm	66mm	£42.00
200 832	8 Tonnes	71mm	70mm	£69.00
200 833	15 Tonnes	71mm	70mm	£119.00

Eyebolts & Eyenuts

COLLARED EYEBOLTS - METRIC



Drop Forged Collared Eyebolts
Metric Thread to BS4278/1
Standard Shank
High Tensile Steel
Self Colour Finish

Part No.	S.W.L.	Eye Ø	Thread	Price
200 647	0.30 Tonnes	15mm	M10	£1.53
200 648	0.40 Tonnes	15mm	M12	£1.63
200 649	0.80 Tonnes	20mm	M16	£2.69
200 650	1.60 Tonnes	27mm	M20	£4.90
200 651	2.50 Tonnes	35mm	M24	£5.52
200 652	4.00 Tonnes	44mm	M30	£18.46
200 654	6.30 Tonnes	57mm	M36	£42.19

COLLARED EYEBOLTS - IMP.



Drop Forged Collared Eyebolts
Whitworth Thread to BS529/1
Standard Shank
High Tensile Steel
Self Colour Finish

Part No.	S.W.L.	Eye Ø	Thread	Price
200 657	0.25 Tons	9/32"	3/8"	£2.71
200 658	0.50 Tons	3/4"	1/2"	£2.68
200 659	0.90 Tons	15/16"	5/8"	£3.42
200 660	1.40 Tons	1.1/8"	3/4"	£4.78
200 661	2.00 Tons	1.5/16"	7/8"	£6.88
200 662	2.75 Tons	1.1/2"	1"	£8.40
200 663	3.50 Tons	1.11/16"	1.1/8"	£39.20

EYEBOLTS - LONG SHANK



Drop Forged Collared Eyebolts
Metric Thread to BS529/1
Long Shank
High Tensile Steel
Self Colour Finish

178mm Shank Length

Part No.	S.W.L.	Eye Ø	Thread	Price
492 240	0.25 Tonnes	14mm	M10	£8.38
492 241	0.40 Tonnes	19mm	M12	£10.26
492 242	0.80 Tonnes	24mm	M16	£13.44
492 243	1.60 Tonnes	28mm	M20	£17.68
492 244	2.50 Tonnes	38mm	M24	£20.32
492 245	4.50 Tonnes	48mm	M30	£41.52

COLLARED EYEBOLTS W/ LINK



Drop Forged Collared Eyebolts
Metric Thread to BS4278/1
Standard Shank
High Tensile Steel
Self Colour Finish

Part No.	S.W.L.	Eye ID	Thread	Price
492 230	0.20 Tonnes	24x53mm	M12	£36.75
492 231	0.40 Tonnes	24x53mm	M16	£39.90
492 232	1.00 Tonnes	24x53mm	M20	£45.50
492 233	1.60 Tonnes	29x63mm	M24	£61.25
492 234	2.50 Tonnes	37x80mm	M30	£78.75

EYENUTS



Eye Nuts to DIN 582 Spec

Part No.	Eye Ø	Thread	Price
492 220	20mm	6mm	£1.39
492 221	20mm	8mm	£1.20
492 222	25mm	10mm	£1.22
492 223	30mm	12mm	£2.47
492 224	35mm	16mm	£3.36
492 225	40mm	20mm	£5.14
492 226	50mm	24mm	£10.22
492 227	60mm	30mm	£17.34

GALVANISED CHAIN

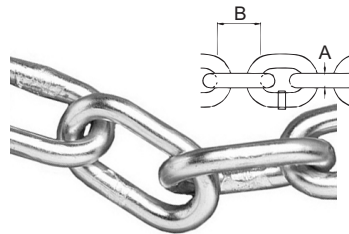

Zinc Galvanised, General Purpose Chain

Mild Steel

(not suitable for lifting)

Part No.	A	B	Length	Price
200 463	3mm	16mm	10m	£12.50
200 462	4mm	20mm	10m	£28.97
200 460	6mm	33mm	10m	£43.54
200 461	6mm	33mm	30m	£93.30
200 459	6mm	42mm	10m	£53.27
200 458	6mm	42mm	15m	£51.50
200 457	8mm	52mm	10m	£53.20
906 1000	10mm	65mm	10m	£134.97
906 1001	12mm	78mm	10m	£73.50

Snatch Blocks

Heavy Duty Snatch Blocks



Heavy Duty Snatch Block with Hook Fitting
Ideal for the recovery industry - double your winching capacity
Heavy duty roller bearing sheaves
Supplied with Test Certificates

Part No.	Head Load	Sheave Ø	Wire Rope Ø	Dimensions	Price
200 316	2 Tons	75mm	7-9mm	292x82x70mm	£56.65
200 317	4 Tons	115mm	10-12mm	358x120x70mm	£110.50
200 318	6 Tons	150mm	16mm	498x160x93mm	£132.30
200 319	8 Tons	205mm	20-22mm	549x210x93mm	£205.80

LIGHT DUTY SNATCH BLOCKS



Light/Medium Duty Snatch Blocks

CE Marked

SWIVEL EYE GIN BLOCK



Swivel Eye Gin Block with drop forged eye bolts
Wheel Diameter: 245mm
Lifting Capacity: 250kg

Supplied with Test Certificate

Part No.	Load	Wire Ø	Price
492 305	200kg	12mm Fibre Rope	£36.75
492 306	250kg	10mm Wire Rope	£44.75
492 307	500kg	8mm Wire Rope	£41.00

Part No.	Description	Price
200 605	Gin Block Only	£45.83
200 606	Gin Block with 15m Nylon Rope & Hook	£98.90
297 020	Gin Block with 30m Nylon Rope & Hook Extra Nylon Rope Available	£127.20

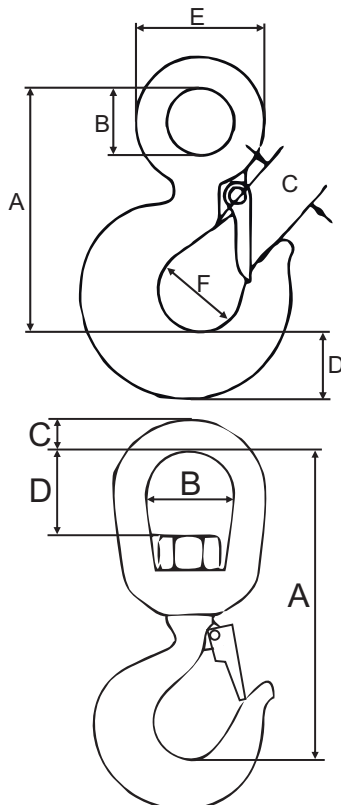

Alloy Steel Eye Hooks

Alloy Steel Eye Sling Hooks c/w Safety Catches

Part No.	S.W.L.	A	B	C	D	E	F	Price
200 607	1 Tonne	81	19	22	20	37	32	£3.16
200 608	1.5 Tonnes	93	19	24	23	44	34	£3.68
200 609	2 Tonnes	104	28	25	27	51	37	£6.08
200 610	3 Tonnes	119	31	28	30	61	40	£7.76
200 611	4.5 Tonnes	146	39	34	40	74	50	£15.40
200 612	7 Tonnes	187	51	43	40	97	60	£20.54

Alloy Steel Swivel Hooks

Alloy Steel Swivel Hooks c/w Safety Catches

Part No.	S.W.L.	A	B	C	D	Price
200 506	1 Tonne	113	31	9	23	£5.24
200 507	1.5 Tonnes	134	38	12	33	£7.48
200 508	2 Tonnes	151	44	15	40	£10.94
200 509	3 Tonnes	161	44	15	41	£11.76
200 510	4.5 Tonnes	189	51	19	44	£22.04
200 511	7 Tonnes	243	63	25	58	£45.24
200 512	11 Tonnes	282	70	28	60	£80.68

Loadbinders & Hoists

Chain Blocks



The sealed bearings in each unit ensure extra protection and allow complete repair flexibility
Twin ratchet brake system
Alloy steel load wheel
Chemically blacked load chain, zinc plated hand chain

Part No.	Height of Lift	S.W.L.	Chain Ø	Price
200 617	3m	0.5 Ton	6mm	£117.00
200 618		1 Ton	6mm	£132.00
200 619		2 Ton	8mm	£149.10
200 620		3 Ton	8mm	£134.70
200 621		5 Ton	10mm	£179.80
200 890	6m	0.5 Ton	6mm	£158.10
200 891		1 Ton	6mm	£170.40
200 892		2 Ton	8mm	£118.70
200 893		3 Ton	8mm	£227.80
200 894		5 Ton	10mm	£297.60
200 880	10m	0.5 Ton	6mm	£123.80
200 881		1 Ton	6mm	£169.30
200 882		2 Ton	8mm	£264.70
200 883		3 Ton	8mm	£217.20
200 884		5 Ton	10mm	£299.00

RATCHET LEVER HOISTS



Ratchet lever hoists
Lift height 1.5m
Simple 1 handed operation
Hardened grade 80 steel chain
Forged upper & lower hooks

MANUAL CABLE PULLER



Tough, all steel construction
Portable, safe & easy to use
High leverage ratio
Supplied with 10ft cable

Part No.	S.W.L.	Chain Ø	Price
906 1005	500kg	5mm	£115.00
200 322	750kg	6mm	£140.60
200 323	1500kg	7mm	£170.20
200 324	3000kg	10mm	£234.30
200 325	6000kg	10mm	£235.40

Part No.	Capacity	Wire Ø	Price
200 680	2000kg	5mm	£37.90
492 285	4000kg	6mm	£79.80

BEAM CLAMPS



Beam Clamps can be mounted easily to beam by threaded handles. The clamp jaw is designed to reduce stress by distributing the load away from the beam flange edge

The clamp can be adjusted to fit a range of flange widths and beams and is fitted with a suspension bar to give lower headroom

All clamps tested to 150% S.W.L. - supplied with a test certificate
Push Trolleys also available from 0.5 to 5 Ton

Part No.	Beam Flange Width	S.W.L.	Pin Ø	Price
200 601	75 - 220mm	1 Ton	20mm	£64.24
200 602	75 - 220mm	2 Ton	20mm	£63.28
200 603	80 - 320mm	3 Ton	28mm	£74.68
200 604	80 - 320mm	5 Ton	28mm	£105.40

Rope Hoists

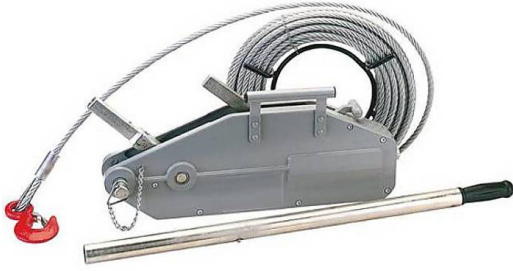

Rope Hoists

Safe, reliable and efficient range of lifting and pulling machines
800KG, 1600kg and 3200kg units available
Suitable for many applications, including construction work and road transport

One man operation

Each machine comes complete with 20 metres of wire rope and safety eye hook

Part No.	Lifting Capacity	Pulling Capacity	Wire Rope Ø	Dimensions	Machine Weight	Price
JRH 800	800kg	1250kg	8mm	235 x 64 x 426mm	6kg	£174.20
JRH 1600	1600kg	2500kg	11mm	280 x 97 x 545mm	11kg	£246.70
JRH 3200	3200kg	5000kg	16mm	325 x 116 x 660mm	22kg	£323.70

RELEASE HANDLE



Release T-Handle for 800kg,
1600kg & 3200kg Rope Hoists

LOCKING PINS



Lock Pin & Chain for JET
Rope Hoists

Part No.	Fits	Price
492 295	800kg & 1600kg Hoist	£30.00
492 296	3200kg Hoist	£27.10

Part No.	Fits	Price
492 292	800kg Hoist	£38.38
492 293	1600kg Hoist	£35.00
492 294	3200kg Hoist	£53.88

20M WIRE ROPE & HOOK



20m Wire Rope complete with
Alloy Steel Eye Hook with
Safety Catch

SHEAR PINS



Shear pins for JET Rope
Hoists

Part No.	Fits	Wire Ø	Price
492 297	800kg Hoist	8mm	£77.82
492 298	1600kg Hoist	11mm	£110.95
492 299	3200kg Hoist	16mm	£125.00

Part No.	Fits	Price
492 290	800kg Hoist	£7.20
200 948	1600kg Hoist	£2.30
200 948	3200kg Hoist	£2.30

SWING TYPE SNATCH BLOCK



Slider Snatch Block
Suits 50mm Tow Bar
Double your winching power, 16,000lbs M.B.S.
Suitable for up to 9mm Wire Rope
100mm Diameter Sheave
2:1 safety Factor
Zinc Plated Finish

Part No.	Price
200 321	£44.74

Untested Fittings

WIRE ROPE GRIPS



Galvanised Wire Rope Grips
EN 13411 part 5 Type A
(Formerly DIN 1142)

Part No.	Wire Rope Size	Price
971 003	3mm (1/8")	£0.48
971 005	5mm (3/16")	£0.48
971 006	6mm (1/4")	£0.30
971 008	8mm (5/16")	£0.40
971 010	10mm (3/8")	£0.50
971 012	12mm (1/2")	£0.90
971 016	16mm (5/8")	£3.13
971 019	19mm (3/4")	£2.94

CARBINE HOOKS



Untested Zinc Plated Carbine
Hooks (snap hooks)

Part No.	Overall Length	Hook Ø	Price
973 004	40mm	4mm	£0.45
973 005	50mm	5mm	£0.75
973 006	60mm	6mm	£0.85
973 008	88mm	8mm	£0.84
973 010	100mm	10mm	£1.30
973 012	140mm	12mm	£2.85
973 014	180mm	14mm	£5.80

SCREW TYPE D-SHACKLES



Untested Galvanised
D-Shackles

Mild steel, commercial type

Part No.	Pin Ø	Jaw Width	Price
970 005	5mm	10mm	£0.73
970 006	6mm	13mm	£0.50
970 008	8mm	15mm	£0.65
970 095	9.5mm	19mm	£0.85
970 016	16mm	32mm	£2.10
970 020	20mm	35mm	£3.00

QUICK LINKS



Untested Zinc Plated Quick
Links

Part No.	Overall Length	Link Ø	Price
974 004	43mm	4mm	£0.75
974 005	63mm	5mm	£0.82
974 006	58mm	6mm	£1.41
974 008	73mm	8mm	£1.00
974 010	90mm	10mm	£2.33
974 012	108mm	12mm	£3.06

WIRE ROPE THIMBLES



Galvanised Heart Shaped
Thimbles

Mild steel, commercial type

Part No.	Wire Rope Ø	Price
972 005	5mm	£0.35
972 006	6mm	£0.35
972 008	8mm	£0.55
972 010	10mm	£0.50
972 012	12mm	£1.02

STRAINING SCREWS



Galvanised Forged Straining
Screws - Hook/Eye

Please contact us if you
require Hook/Hook or
Eye/Eye

Part No.	Overall Length	Thread	Price
975 006	43mm (x2)	6mm	£2.54
975 008	63mm (x2)	8mm	£1.95
975 010	58mm (x2)	10mm	£4.68
975 012	73mm (x2)	12mm	£3.34
975 016	90mm (x2)	16mm	£11.12

Stainless Steel fittings also available
Please contact us for details.

Untested Fittings

SWIVEL HOOKS



Zinc Plated Swivel Spring Hooks

Part No.	Overall Length	Price
200 667	2"	£1.19
200 668	2.1/2"	£1.58
200 669	3"	£1.55
200 670	3.1/2"	£1.76
200 671	4"	£2.40

SPRING HOOKS TO CRUE



Zinc Plated Spring Hooks to Crue

Part No.	Overall Length	Price
200 673	2"	£1.23
200 674	2.1/2"	£1.20
200 675	3"	£1.10
200 676	3.1/2"	£1.50
200 677	4"	£2.05

NYLON COATED WIRE ROPE



Ideal for Securing Small Parts such as Pins and Tools to Equipment and Numerous other Applications.

100m Rolls

Part No.	Wire O/D	Price
200 665	2mm	£21.75
492 315	3mm	£40.32
492 316	4mm	£40.10
492 317	5mm	£61.83

LASHING RING



Zinc Plated Lashing Ring

Ring I/D: 50mm
4 Fixing Holes at 32mm Centres

Part No.	Price
492 310	£1.73

S.W.L. TAGS



Safe Working Load Tags
Clip on Type

Part No.	Price
200 595	£1.95

ALUMINIUM FERRULES



Aluminium Ferrules to suit Nylon Coated Wire Rope
Easy to Crimp

Bag of 100

Part No.	Wire O/D	Price
200 666	2mm	£5.50
492 320	3mm	£8.75
492 321	4mm	£13.20
492 322	5mm	£14.30

WIRE ROPE CUTTERS



Cuts Mild & Bowden Cable, Spring Steel Wire, Braided Wire, Fencing Wire, Wire Rope, Round Steel, Steel Rods etc. up to 6mm Diam.

Part No.	Price
902 1890	£28.50

LOCKING WIRE



Galvanised Locking Wire
1/2 Kilo Reels
O.D. 1.6mm

Part No.	Price
705 150	£18.62

CRIMP PLIERS



Ratchet Crimp Pliers

Part No.	Price
200 779	£17.50

Loadbinders & Lorry Nets



Skip/Debris Nets

Available in standard duty fine mesh fitted with 8mm diameter polypropylene rope ties at 4ft and 5ft intervals

Part No.	Dimensions	Price
492 341	15 x 9ft (4.25 x 2.75m)	£59.00
492 343	18 x 12ft (5.5m x 3.5m)	£74.00
492 345	22 x 14ft (6.7 x 4.25m)	£134.80

TARPAULINS



Blue Polythene Tarpaulins with Eyelets for Load Covering, Groundsheets etc.

Part No.	Dimensions	Price
895 298	3.5 x 5.5m	£21.59
492 362	4.5 x 6m	£25.50
492 363	5.4 x 7m	£29.00
492 364	7 x 9m	£39.00
492 365	7 x 11m	£46.90
492 366	9 x 14m	£88.20
492 368	12 x 20m	£140.00

LORRY/BRICK NETS



For Covering loads on Skips, Vans & Trucks

3mm Heavy Duty Nylon Twine
Double Knotted
2" Square Mesh
5mm Rope Border

Part No.	Dimensions	Price
492 350	12' x 8' (3.25m x 2.4m)	£76.80
492 351	15' x 9'6" (4.25 x 3m)	£127.20
492 352	16' x 10' (5 x 3m)	£95.00
492 353	18' x 12' (5.5 x 3.5m)	£135.00
492 354	20' x 12' (6 x 3.5m)	£150.00
492 355	24' x 12' (7.25m x 3.5m)	£174.30

STANDARD LOADBINDERS



Heavy Duty Drop Forged Standard Loadbinder

Double hooks and 380mm long handle for increased leverage

Part No.	Chain Size	Load Limit	Price
492 215	6-8mm	3,538kg	£23.79
200 629	8-10mm	8,630kg	£28.54
200 630	10-13mm	15,000kg	£45.50

RATCHET LOADBINDERS



Heavy Duty Drop Forged Ratchet Loadbinders. Turnbuckle screws to pull load chain up to 250mm

Double hooks and 380mm long handle for increased leverage

Part No.	Chain Size	Load Limit	Price
492 213	6-8mm	3,538kg	£26.80
200 631	8-10mm	8,575kg	£36.02
200 632	10-13mm	14,700kg	£39.10
492 214	13-16mm	20,650kg	£49.36

GRADE 80 TESTED LIFTING CHAIN



Grade 80 Chain to BS-EN818

Grade 80 Tested Chain is

recommended when using ratchet loadbinders or when securing heavy plant as well as lifting applications.

Supplied with Test Certificate.

Please refer to page C-2 for the full range of all Grade 80 Tested Lifting Chain Lengths available.

Ratchet Straps

50MM RATCHET LOADSTRAPS



Heavy Duty Ratchet Loadstrap
Assembly
50mm Wide c/w Ratchet

5000kg Securing Capacity

Part No.	Length	Price
LS6	6 metre	£12.50
LS8	8 metre	£17.50
LS10	10 metre	£15.98

35MM RATCHET LOADSTRAP



Medium Duty 35mm Wide
Loadstrap Assembly
6 metre Length c/w Ratchet

2000 kg Securing Capacity

Part No.	Price
200 585	£9.92

50MM RATCHET ONLY

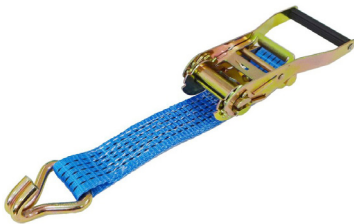

Ratchet Mechanism Only
Complete with 12" Tail

50mm Wide Strap & Hook

Part No.	Price
200 587	£3.62

25MM RATCHET LOADSTRAP



Lightweight 25mm Wide
Loadstrap Assembly
5 metre Length c/w Ratchet

800kg Securing Capacity

Part No.	Price
200 586	£6.35

PALLET CORNER PROTECTOR



Corner Protectors used to Protect
Pallets from Damage

Available in 50mm, 60mm, 100mm,
800mm and 1150mm Wide

Part No.	Size	Price
203 612	50mm	£1.00
203 613	60mm	£4.90
203 614	100mm	£2.25
203 615	800mm	£14.93
203 616	1150mm	£18.17

WEAR SLEEVE



12" Wear Sleeve to suit
50mm Wide Straps

Part No.	Price
200 594	£0.95

25MM BUDGET RATCHET STRAP



Budget 25mm Wide Loadstrap
4.5m Length c/w Ratchet

135kg Securing Capacity

Part No.	Price
300LS	£4.32

WHEEL STRAP



15" Wheel Strap for 50mm
Wide Load Straps

Part No.	Price
200 591	£19.76

Diesel & Fuel Equipment



Fuel Trigger Nozzle - Auto Shut Off

Will not operate with gravity feed systems. Nozzle shuts off automatically when liquid covers the vent hole at the end of the spout. For use with diesel/gas oil. 1" BSP swivel inlet. Pumps should deliver a minimum of 13Ltr/min to activate 'shut-off' mechanism. Built in check valve, low-flow 'shut down', simple lever catch.

Maximum pressure 3 bar
60Ltr/min
25mm O/D nozzle

Part No.	Price
J3070	£58.00

TRIGGER NOZZLE - MANUAL



Fuel Trigger Nozzle with 1" BSP Female Fitting
Gravity Fed

Part No.	Price
J3063	£16.95

HOSE & GUN ASSEMBLY



Fuel Hose, Trigger Nozzle & Tap
Hose with 1" BSP Fittings,
Nozzle & 90° Lockable Tap

Part No.	Size	Price
A1000SE	3m Hose	£58.63
A9006SE	6m Hose	£72.43

FUEL HOSE ASSEMBLY



1" Fuel Hose complete with 1" BSP Male Fittings

Part No.	Size	Price
866 113	3m Hose	£27.20
866 116	6m Hose	£41.00

TANK FLOAT GAUGES



Suitable for Diesel Fuels, Heating Oil, Lube Oils or Water, Provides a Simple, Rough Indication of Tank Content - EMPTY 1/4, 1/2, 3/4 or FULL, Accuracy +/- 5% (approx) Mounts Directly into the Top of Tank (1.1/2" BSP Thread)

Part No.	Type	Price
812 451	4ft Deep Tanks	£17.75
812 452	5ft Deep Tanks	£22.11
812 450	6ft Deep Tanks	£20.50

FUEL HOSE - DIESEL



1 Inch Bore Black Diesel Hose
Without any connections
or fittings

Part No.	I/D	Length	Price
124 0308	1"	5m Roll	£33.92
124 0309	1"	10m Roll	£95.20
124 0310	1"	25m Roll	£159.70

MECHANICAL FLOWMETER



4 Figure Display In Litres (Resettable)
Max Work Pressure 3.5 Bar
8 Digit Totalizer (Non-Resettable)
Minimum Flow Rate 20 Ltr/Min
1" BSP Inlet/Outlet

Part No.	Price
800 800	£79.30

ANGLE GATE VALVE



Lockable Brass Angle Gate Valve/Tap

1" BSP (Male/Female) 90° PN20 fitting

Part No.	Price
866 110	£18.83

INLINE DIGITAL FLOWMETER



Flow Range 10-100 Ltr/min
Display: Batch 999.9,
Cumulative 9999
Powered by 2 x AAA Batteries
Max Operating Pressure 20.7 bar
1" BSP Inlet/Outlet

Part No.	Price
M0087	£207.20

Diesel & Fuel Equipment

DIESEL PUMP, HOSE & GUN KIT



Pump, Hose & Trigger Nozzle
550 Watt, 2.8 Amp Diesel Pump
60 Ltrs Per Min
Max Head 20m
1" BSP Ports, Built In Filter
3m Delivery Hose.
2m Suction Hose.

Part No.	Description	Price
317 62K	240v Kit	£247.50
317 61K	110v Kit	£264.50

DIESEL PUMP, HOSE & GUN KIT



Pump, Hose & Trigger Nozzle
12/24v Electric Diesel Pump
40 Ltrs Per Min
1" BSP Ports
2m Battery Lead
3m Delivery Hose.
2m Suction Hose.
Max Runtime 30 mins

Part No.	Description	Price
307 512	12v Kit	£189.00
307 524	24v Kit	£185.60

DIESEL PUMP



550 Watt, 2.8 Amp Diesel Pump
60 Ltrs Per Min
Max Head 20m
Weight 7Kg
1" BSP Ports, Built In Filter

Part No.	Description	Price
307 624	240v Diesel Pump	£184.60
307 611	110v Diesel Pump	£235.00

SUBMERSIBLE PUMP KITS



Suitable for Diesel, Various
Chemicals, Fresh & Dirty Water
Ideally Suited to On-Site Diesel
Refuelling, Flowrate 18 Ltrs Per
Min Supplied with 3m Clear Hose
Pump must not be allowed to
run dry

Part No.	Description	Price
A1100SE	12v Kit	£42.00
A1101SE	24v Kit	£45.00

FUEL SYPHON KIT



For Transferring Fuel, Pumping
Fuel into Heater, Extracting
Fluid from Tanks, Priming Fuel
Lines etc.

Part No.	Price
J2655	£15.70

240V PUMP HOSE & GUN KIT



240V Pump Hose & Gun Kit /w
Flowmeter

Self-Priming Pump
4 Stage Flow Setting with Auto
Shut-off Nozzle
Brass Suction Strainer with One-
Way Valve

Part No.	Price
307 102	£290.72

MANUAL DIESEL PRIMER PUMP



Manual Inline Diesel
Hand Primer Bulb

Size: 8mm (5/16") Tails

Part No.	Price
080 005	£10.50

FILTER & NON RETURN VALVE



1" BSP Pickup Filter/Strainer
with Non Return Valve
Suitable for 1" Diesel Fuel Kits

Part No.	Price
P4606SE	£15.23

BRAIDED LEAK OFF PIPE



Cotton Overbraided Fuel Pipe
Suitable for Diesel, Petrol & Oil
DIN SPEC 73379 TYPE B 1983
Working Pressure 150PSI
(10 BAR)

Part No.	I/D	Length	Price
200 437	3.2mm	5m	£8.82
200 438	3.5mm	5m	£9.98
200 439	5mm	5m	£12.01
200 440	6mm	5m	£12.00
200 441	8mm	5m	£13.00
200 442	10mm	5m	£15.25

INLINE FUEL FILTER



Inline Fuel Filter Assembly
1" BSP In/Out
Max Pressure 10.7 Bar
Complete with filter element

Part No.	Description	Price
A1003/G	Particulate Filter	£50.95
A1003/WG	Water Separator	£55.15
J3049/G	Particulate Filter Element	£10.93
J3049/WG	Water Block Filter Element	£14.38

Greasing



Side Lever Mechanical Grease Gun

Economical Grease Gun with Crank Tube & 4 Jaw Coupler
Ram-rod system for cartridge loading
500cc bulk fill or 400g cartridge
Knurled barrel for non-slip grip
Plastic handle grip
Removable end cap for ease of cleaning

Part No.	Price
J0156R	£9.25

'SPRINGLESS' GREASE GUN

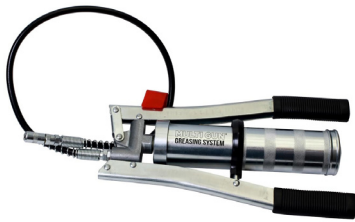

Heavy duty springless grease gun - uses vacuum principal
Suitable for all 400/500g standard & threaded grease cartridges

Part No.	Price
A1036MG	£36.75

'SPRINGLESS' GREASE GUN



Heavy Duty Side Lever Springless Greasing Gun Kit
Uses Vacuum Principal Complete with 200mm Flexible Hose, 4-Jaw Coupler & 5 Follower Seals
Suitable for 400g Standard Cartridges

Part No.	Price
A1038	£8.95

'PISTOL GRIP' GREASE GUN



Certalube Pistol Grip Grease Gun c/w Solid & Flexible Hose
Adjustable Pistol Lever
400g Cartridge or 500cc Bulk

Part No.	Price
A1025	£39.90

GREASE GUN CONNECTOR



Lock n Lube Type Grease Gun Connector
1/8 inch BSP thread
Rated to max 10 000 psi.

Part No.	Price
812 115	£22.92

'AIR DRIVEN' GREASE GUN



Cranked Extension Tube
400g Cartridge or 500cc Bulk
Can be used with Vehicle or Workshop Compressors up to 3cfm c/w PCL Male Coupling

Part No.	Price
200 045	£28.50

GREASE GUN DELIVERY PIPE



Flexible Greasing Hoses with 1/8" BSP Male Ends
400 bar Working/900 bar Burst Pressure

Part No.	Length	Type	Price
J0112	12"	Nylon	£2.40
J0112R	12"	Rubber	£3.60
J0118	18"	Nylon	£4.55
J0118R	18"	Rubber	£5.45

AIR DRIVEN GREASE GUN



Air Driven Grease Gun Rigid Stem.
Four Jaw Connector.
Bulk Fill or Cartridge.
120psi, Max 6 Bar

Part No.	Price
635 200	£70.47

'PUSH TYPE' GREASE GUN



Push Type (Pom Pom) Grease Gun c/w Push on Connector
Length: 250mm
Capacity: 130cc (4.1/2oz)

Part No.	Price
200 250	£14.13

J0515	£2.55	
635 157	£0.78	
635 175	£6.77	
635 174	15mm	£4.54
J00508	22mm	£15.77

Greasing



Multipurpose Grease - 400g

This Lithium grease is highly recommended for wheel bearings and chassis lubrication. Particularly suited for the lubrication of construction and mining equipment such as bulldozers, scrapers, loading shovels and all off highway trucks where greased components are subjected to continuous heavy loads and shock loads.

Part No.	Price
G2/400	£2.76

M/PURPOSE GREASE - 36 PACK



Multipurpose Lithium Grease
36 x 400g

Part No.	Price
G2/36400	£95.00

M/PURPOSE GREASE 12.5KG



Multipurpose Lithium Grease
12.5kg Drum

Suitable for use with our High Pressure Drum Greaser

Part No.	Price
G2/125	£82.70

BUCKET GREASER



High Pressure Grease Pump
For Mounting Directly onto
12.5kg Grease Kegs

1.5m Hose
Max Pressure: 350 bar
2cc Delivery per Stroke

GENERAL PURPOSE GREASE

General Purpose Lithium
Grease 400ml



Suitable for Grease Gun
A1036MG

Part No.	Price
G2/LS400	£4.47

Part No.	Description	Price
J4512SE	Bucket Greaser	£106.80
A1014SE	Spare Hose & Delivery Pipe	£19.18

FIXT GREASE - 500G TUBS

FIXT Grease - 500g Tubs



Part No.	Description	Price
FX081157	CV Joint Grease	£10.26
FX081160	Lithium EP2 Grease	£5.71
FX081156	Copper Grease	£8.15

GREASE NIPPLE - STRAIGHT



Straight Grease Nipples
Imperial

Part No.	Thread	Price
635 152	1/4" UNF	£0.16
635 155	5/16" UNF	£0.40
635 158	1/8" BSP	£0.22
635 161	1/4" BSP	£0.38
635 195	1/4" BSF	£0.14
635 197	5/16" BSF	£0.20
635 201	3/8" BSF	£0.27

GREASE NIPPLE - 45° METRIC



45° Angled Grease Nipples
Metric

Part No.	Thread	Price
635 165	M6 x 1	£0.33
635 167	M8 x 1	£0.32
635 169	M10 x 1	£0.45
635 182	M8 x 1.25	£0.45
635 205	M10 x 1.5	£0.57

Oils

Stihl 2-Stroke Engine Oil

Top selling mineral oil 2-stroke engine oil. Specially developed for STIHL engines. Excellent lubrication and combustion properties.

Part No.	Size	Price
0781 319 8401	1 x 100ml single shot	£1.45
350 400	10 x 100ml single shots	£13.00
350 410	1 litre with measure	£10.25
350 420	5 litre	£27.68



STIHL HP SUPER 2-STROKE OIL



Specially for mix-lubricated two-stroke and four-stroke engines in handheld power tools. It combines excellent lubrication with very clean burning. (5L of unleaded petrol per shot)

Part No.	Description	Price
0781 319 8052	Single Shot (100ml)	£2.16
358 401	10 x 100ml Shots	£23.00

STIHL HP ULTRA 2-STROKE OIL



Fully synthetic oil with exceptional lubrication properties. Burns with extremely low residue due to ash-free additive. Performance class: JASO-FD, ISO-L-EGD. Fuel/oil ratio 1:50

Part No.	Description	Price
0781 319 8060	Single Shot (100ml)	£2.88
358 400	10 x 100ml Shots	£33.42

HUSQVARNA OIL GUARD



Husqvarna Oil Guard 2-Stroke Oil One Shot 100ml Bottles Premium 2-stroke oil suitable for all 2-stroke machines and required for 'Oil Guard'

Part No.	Description	Price
790 90 00 01	Single Shot (100ml)	£2.45
760 111	10 x 100ml Shots	£21.38

ATLAS COPCO COBRA MIX



Cobra Mix 2-Stroke Oil 100ml (Single Shot) (5L of unleaded petrol per shot)

Part No.	Description	Price
940 100	Single Shot (100ml)	£5.42
9238 2743 40	12 x 100ml Shots	£65.08

2-STROKE 1L MIXING BOTTLE



1 Litre 2-Stroke Oil and Fuel Mixing Bottle, for Accurately Measuring then Mixing a 2 Stroke Oil and Petrol Mix.

Part No.	Price
804 200	£2.90

HONDA 4-STROKE OIL



Genuine Honda 10W30 API / SJ Engine Oil for Honda 4 Stroke Engines

Part No.	Price
08221 888 101HE	£15.20

ENGINE OIL



Specially formulated fully & semi-synthetic engine oils meeting stringent European performance specifications for turbo charged and naturally aspirated petrol and diesel engines working under tough conditions

Part No.	Description	Type	Size	Price
867 700	5W/30	Semi Synthetic	1 Litre	£5.50
867 300	5W/30	Semi Synthetic	5 Litre	£21.18
867 800	5W/30	Fully Synthetic	1 Litre	£6.50
867 500	5W/40	Fully Synthetic	1 Litre	£6.50
867 600	10W/40	Semi Synthetic	1 Litre	£5.50
867 200	10W/40	Semi Synthetic	5 Litre	£18.80

EP90 GEAR OIL



EP90 Gear Oil suitable for Belle Minimix 150 Gearbox, 1 Litre Bottle

Part No.	Price
EP90	£5.95

Greasing

GREASE NIPPLE - 45° IMPERIAL



45° Angled Grease Nipples
Imperial

Part No.	Thread	Price
635 153	1/4" UNF	£0.36
635 156	5/16" UNF	£0.41
635 159	1/8" BSP	£0.38
635 162	1/4" BSP	£0.72
635 196	1/4" BSF	£0.46
635 198	5/16" BSF	£0.42
635 202	3/8" BSF	£0.50

GREASE NIPPLE - 90° METRIC



90° Angled Grease Nipples
Metric

Part No.	Thread	Price
635 181	M6 x 1	£0.36
635 189	M8 x 1	£0.35
635 191	M10 x 1	£0.36
635 183	M8 x 1.25	£0.36
635 185	M10 x 1.5	£0.47

GREASE NIPPLE - 90° IMPERIAL



90° Angled Grease Nipples
Imperial

Part No.	Thread	Price
635 186	1/8" BSP	£0.38
635 187	1/4" UNF	£0.34

GREASE NIPPLE - STRAIGHT METRIC



Straight Grease Nipples
Metric

Part No.	Thread	Price
635 164	M6 x 1	£0.16
635 166	M8 x 1	£0.20
635 168	M10 x 1	£0.19
635 184	M8 x 1.25	£0.20
635 204	M10 x 1.5	£0.19

GREASE NIPPLE - HEX HEAD



Imperial Hexagon Head
Tap Grease Nipples

Part No.	Thread	Price
635 160	1/8" BSP	£0.44
635 163	3/8" BSF	£0.42
635 193	1/4" BSP	£0.46

GREASE NIPPLE - LONG

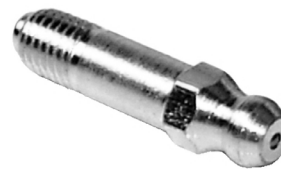

1/4" UNF
Long Straight Grease Nipple

Part No.	Price
635 154	£0.36

121 IMPERIAL GREASE NIPPLES



121 Imperial Grease Nipples
Angled & Straight. Zinc Plated
BSP Sizes: 1/8" (Hex, Straight,
45°, 90°). 1/4" (Straight).
UNF Sizes: 1/4" (Straight, 45°,
90°)
1/4" Long (Straight)

Part No.	Price
105 255	£33.15

135 METRIC GREASE NIPPLES



135 Metric Grease Nipples
Angled & Straight. Zinc Plated
M8 x 1 (Straight)
M8 x 1.25 (Straight, 45°, 90°).
M10 x 1mm (Straight, 90°)

Part No.	Price
105 256	£31.52

Oil Handling

Vacutank Vacuum Pump

For Vehicles

Handy tool makes vehicle maintenance easy - use it to change oil or drain radiators & transmission.

For Boat & Caravan

Vacutank is the perfect way to empty bilges and water systems.

Trapped Liquids

It removes all kinds of liquids, even those with grit, shavings & sand. Clears all types of drains and acts as temporary sump in emergencies.

This valuable tool has a 4 litre capacity, no overflowing or spillage and 2 pieces of clear suction hose.

Please Note: New Style Vacutank		
Part No.	Description	Price
806 250	Vacutank	£27.61



HD GEAR OIL BUCKET



Steel Gear Oil Bucket complete with fully reversible hand rotary pump, clear PVC hose & nozzle

Hard powder coat finish as standard 10.5 Litres (2.3 Gallons) capacity

Delivers and retrieves

Part No.	Price
A6000SE	£207.70

VACUUM OIL EXTRACTOR



Vacuum Oil & Fluid Extractor 6 Litre Capacity vacuum extraction pump constructed from composite materials and suitable for the extraction of all types of engine, transmission and lubricating oils

Complete with suction probes and a 1 metre extension tube

Part No.	Price
806 200	£49.00

HANDHELD SUCTION GUN



500cc Extraction Gun supplied with 270mm flexitube

Part No.	Price
866 899	£11.33

WASTE CONTAINER 23 LITRE



Waste Water/Oil Container - 23 Litre

Ideal for workshops & caravans Large opening for double waste pipe

Size 410mm x 340mm x 220mm

Part No.	Price
200 706	£16.30

OIL CANS - 500ML



500ml Oil Cans Supplied with Flexible Spout

Part No.	Description	Price
895 177	Steel Body	£5.78
895 071	Polythene Body	£7.50

OIL DRAIN PANS



Multipurpose Drain Pans High Density Polyethylene Includes Oil Filter Drainer Shelf Resistant To Petrol, Oil, Diesel & Solvents

Part No.	Capacity	Size	Price
895 050	5 Litre	13 x 4"	£5.20
895 075	8 Litre	16 x 4"	£10.38

Environment Control

ENVIROPADS



Innovative spill pad locks in hydrocarbons permanently.
Smart polymer turns oil and fuel into solid rubber.
Can be safely left out in the rain and jet washed.
Suitable for indoor and outdoor use.
Does not require sidewalls or a liner.

Part No.	Description	Capacity	Price
520 201	S - 61cm x 46cm	4.5 Litres	£77.04
520 202	M - 90cm x 69cm	10.5 Litres	£139.50
520 203	L - 137cm x 91cm	20 Litres	£240.30
520 204	XL - 137cm x 137cm	30 Litres	£295.50
520 205	XXL - 218cm x 137cm	520 206	£356.10

DRAIN FILTERS



Envirohorn Drain Filters - 100 Micron.

Size: 25cm diameter, 40cm depth.
Water discharged to EA-accepted levels.
Reusable.

Ideal for house building sites, wheel wash areas, entrances and exits to construction sites, motorway projects.

Fit EnviroHorn to drain; refit drain cover; cut to size; tape down edges.

Part No.	Flow Rate	Capacity	Price
520 225	130L/min	1L Oil, 19kg Sediment	£97.50
520 226	140L/min	21kg Sediment	£90.00

DEWATERING FILTERS



Sediment Dewatering Filter.

Can be Reused up to 20 Times.
Water discharged to EA-accepted levels.

Part No.	Flow Rate	Capacity	Price
520 206	450L/min	20kg Sediment	£41.47
520 207	450L/min	20kg Sediment	£75.98
520 208	800L/min	40kg Sediment	£131.10
520 209	300L/min	2.5L Oil, 20kg Sediment	£163.20

DETECTION STRIPS



Oil Detection Strips - 100 Strips.
Size: 8 x 5 cm.

Immediate detection of hydrocarbons in water.
Test standing water before dewatering or disposal.
Test water after spill response to check purity.
Avoid pollution incidents and fines.
Detect 1ppm oil.

Part No.	Price
520 246	£80.30

*Please See Our Workshop Absorbents Section for Absorbent Pads and Cleaning Products.

Drip Trays

HEAVY DUTY STEEL DRIP TRAYS



Untreated, fabricated steel drip tray with handles - made to last.
Protect floors and driveways from engine and gearbox drips.
Ideal for protecting floors from drips when used under generators, water pumps and other small plant.

Part No.	Description	Size L x W x H	Price
200 625	Small Metal Drip Tray	610 x 610 x 50mm	£40.00
200 626	Medium Metal Drip Tray	914 x 610 x 50mm	£45.00
200 627	Large Metal Drip Tray	1220 x 1118 x 50mm	£101.70

FLEXI TRAYS & GRIDS

Flexi Trays Available with and without Grids.
*Line with Absorbent Pads for Easy Cleaning.

Part No.	Description	Size L x W x H	Capacity	Price
934 006	Small Flexi-Tray	520 x 520 x 50mm	12 Litres	£31.82
934 1081	Medium Flexi-Tray	1020 x 520 x 50mm	24 Litres	£41.64
934 007	Large Flexi-Tray	1020 x 1020 x 50mm	48 Litres	£58.05
934 1083	Small Flexi-Tray w/ 1 Grid	520 x 520 x 50mm	11 Litres	£34.41
934 1084	Medium Flexi-Tray w/ 2 Grids	1020 x 520 x 50mm	22 Litres	£44.37
934 009	Large Flexi-Tray w/ 4 Grids	1020 x 1020 x 50mm	44 Litres	£74.62



FLEXI TRAY W/ OIL-SORBENT MAT



Part No.	Description	Size L x W x H	Absorbency	Price
934 1104	Small Flex Tray w/ Mat	550 x 700 x 100mm	4 Litres	£61.15
934 1106	Medium Flex Tray w/ Mat	700 x 1050 x 100mm	9 Litres	£84.40
934 1108	Large Flex Tray w/ Mat	1000 x 1050 x 100mm	18 Litres	£170.20
934 1110	XL Flex Tray w/ Mat	1370 x 2000 x 100mm	32 Litres	£358.00

*Please See Our Workshop Absorbents Section for Absorbent Pads and Cleaning Products.

Drip Trays

SPILL TRAPPER MATS (PACK OF 2)

Replacement SpillTector Oil & Fuel Absorbent Matting pack of 2.

Part No.	Description	Size L x W x H	Capacity	Price
934 1112	Small SpillTector	510 x 660 x 100mm	4 Litres	£43.13
934 1113	Medium SpillTector	660 x 1010 x 100mm	9 Litres	£71.07
934 1114	Large SpillTector	960 x 1460 x 100mm	18 Litres	£149.90
934 1115	X Large SpillTector	1330 x 1960 x 100mm	32 Litres	£228.00



PLASTIC DRIP TRAY



Plastic Drip Tray
External: 640 x 490 x 120mm
Internal: 560mm x 410mm
2.4mm Thick

PLASTIC SPILL TRAY



Plastic Spill Tray
630mm x 590mm x 170mm
45ltr Capacity

Part No.	Price
200 624	£13.45

Part No.	Price
934 001	£51.23

DRUM TRAYS



Made from 100% Recycled Polypropylene Can be Stacked when not in use for Optimum Storage Integrated Drainage Grid in Base of Tray Meets 2001 Oil Storage Regulations

Part No.	Description	Size L x W x H	Max. Load	Sump	Price
934 1086	2 x 25 Litre	640 x 490 x 120mm	50kg	28L	£24.18
934 1087	5 x 25 Litre	800 x 800 x 120mm	200kg	60L	£51.56
934 1088	6 x 25 Litre	1000 x 550 x 150mm	200kg	60L	£42.30
934 1089	9 x 25 Litre	1010 x 1000 x 120mm	200kg	100L	£79.50
934 1090	16 x 25 Litre	1200 x 1200 x 120mm	250kg	120L	£94.02

DEEP DRIP TRAYS

*Line with Absorbent Pads for Easy Cleaning.

Part No.	Description	Size L x W x H	Capacity	Price
200 624	Medium Deep Tray	640 x 490 x 120mm	28 Litres	£13.45
934 1076	Large Deep Tray	1000 x 550 x 150mm	40 Litres	£25.10
934 1077	Extra Med Deep Tray	800 x 800 x 120mm	60 Litres	£26.20
934 1078	Giant Deep Tray	1010 x 1000 x 120mm	100 Litres	£52.32



*Please See Our Workshop Absorbents Section for Absorbent Pads and Cleaning Products.

Drip Trays

4 Drum In-Line Spill Pallet

Capacity 235 Litres
Dimensions 2450mm W x 660mm D x 270mm H
Max Load 1250kg.
(Drums not Included)



Part No.	Price
934 1168	£358.00

2 DRUM SPILL PALLET

3 DRUM IN-LINE SPILL PALLET



Capacity 250 Litres
Dimensions 1300mm W x 750mm D x 400mm H
Static Load 900kg.

Capacity 228 Litres
Dimensions 1790mm W x 780mm D x 240mm H
Static Load 900kg (Drums not Included).

Part No.	Price
934 1158	£271.70

Part No.	Price
934 1162	£528.00

4 DRUM SPILL PALLET 245L

4 DRUM SPILL PALLET 250L



Capacity 245 Litres
Dimensions 1380mm W x 1290mm D x 280mm H
Static Load 2700kg.

Capacity 250 Litres
Dimensions 1620mm W x 1220mm D x 160mm H
Removable Drum Grid
Can Store 4x 200L drums Indoors (Drums not Included).

Part No.	Price
934 1164	£304.80

Part No.	Price
934 1163	£181.80

Spill Kits

20 LITRE DRIP TRAY SPILL KITS

General Purpose



Oil & Fuel



Chemical



20 Litre Drip Tray Spill Kits

Oil & Fuel, General Purpose and Chemical Spill Kits

Each Spill Kit Contains:

1 x Clip-Close Carry bag

1 x Absorbent Socks 80mm x 1200mm

15 x Absorbent pads 400mm x 500mm

1 x Disposal bag & tie

1 x Instruction / Front Label

1 x Drip Tray 580mm x 450mm x 70mm

Part No.	Type	Price
934 1009	20L General Kit & Drip Tray	£27.27
934 1010	20L Oil & Fuel Kit & Drip Tray	£25.53
934 1011	20L Chemical Kit & Drip Tray	£29.44

HOLDALL SPILL KITS



Oil & Fuel, General Purpose and Chemical Spill Kits in a Tough Weather Proof Holdall with Carry Strap. Ideal for Workshops, Sites & Vehicles.

Part No.	Type	Price
934 1024	30L General Kit	£59.42
934 1025	30L Oil & Fuel Kit	£60.62
934 1026	30L Chemical Kit	£64.46
934 1027	50L General Kit	£77.73
934 1028	50L Oil & Fuel Kit	£72.17
934 1029	50L Chemical Kit	£86.60

OIL & FUEL SPILL KIT MOBILE & WHEELIE-BIN



90L Clip-Top Bin Spill Kit



120L Wheelie-Bin Spill Kit



240L Wheelie-Bin Spill Kit

Part No.	Type	Price
934 1030	Yellow Bin	£105.20
934 1031	Blue Bin	£106.20
934 1032	Refill Kit	£84.10

Part No.	Type	Price
934 1033	Yellow Bin	£155.70
934 1034	Blue Bin	£138.50
934 1035	Refill Kit	£98.70

Part No.	Type	Price
934 1036	Yellow Bin	£235.10
934 1037	Blue Bin	£224.20
934 1038	Refill Kit	£155.90

Spill Kits & Plant Nappies



25ltr Spill Kit

Fast action kit in a tough waterproof holdall with carry strap
Contains 20 pads, 2 x 1.2m socks, 1 pair gloves, 2 bags and tie

Absorbs up to 25 litres

Part No.	Size	Price
534 210	Spill Kit - 25ltr	£49.00
534 200	Refill	£35.49



50ltr Spill Kit

Fast action kit in a tough waterproof holdall with carry strap
Contents: 1 x Hi-viz Shoulder bag, 30 x pads, 3 x cushions, 3 x 1.2m socks, 1 x Goggles, 1 x Pair Gauntlet gloves, 5 x Disposal Bags

Absorbs up to 50 litres

Part No.	Size	Price
534 065	Spill Kit - 50ltr	£85.80
534 213	Refill	£51.59

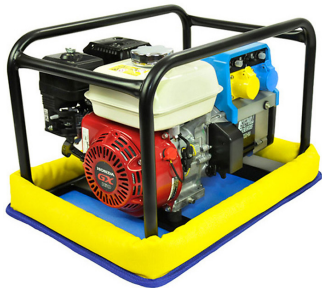

Plant Nappies

Plant Nappies are a light and user friendly method of spill containment; designed to replace existing, traditional drip trays. Designed to withstand all weather conditions, it is rugged enough to stand plant on it all year round to contain the odd mishap that could occur on site.

Part No.	Size	Price
392 050	500mm x 690mm	£96.50
392 100	1000mm x 690mm	£161.60
392 201	2000mm x 1370mm	£367.00



Plant Nappy Liners

Part No.	Description	Size	Price
391 050	Liner for 392 050	500mm x 685mm	£19.66
391 100	Liner for 392 100	1000mm x 685mm	£33.20
391 201	Liner for 392 201	2000mm x 1375mm	£134.10

ABSORBENT SOCK STANDARD



Surrounds & Contains Spills & Leaky Equipment

Size: 1200mm x 80mm

ABSORBENT SOCK SELECTIVE



Repels Water & Water Based Liquids, Only Absorbs Oils & Fuels

Length: 1200mm x 80mm

Part No.	Price
865 177	£2.65

Part No.	Price
934 005	£3.03

ABSORBENT DRUM TOP PADS

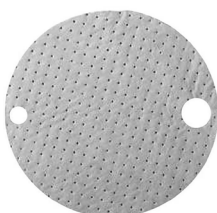

Absorbent Drum Topper Pads
560mm Diameter fits 205ltr Drums
Absorbs Oils & Fuel
Catches Drips & Spills

DRUM TOP PADS PACK OF 5



Pack of 5
Absorbent Drum Topper Pads
560mm Diameter fits 205ltr Drums, Absorbs Oils & Fuel
Catches Drips & Spills

Part No.	Price
804 100	£2.56

Part No.	Type	Price
934 1049	General Purpose	£11.65
934 1057	Oil & Fuel	£11.74

Absorbents

SUPERWHITE GRANULES



MULTI-ZORB Super Absorbant Granules
Inert Non-Flammable Clay Granules, for all Work Place Spillages
20ltr, 15kg Bag

Part No.	Price
934 1101	£11.00

DRUM DRIP TRAY



Polyethylene Drum Trays

870 x 190mm High

Part No.	Capacity	Price
870 190	50 Litres	£82.00
934 1185	54 Litres	£83.90

ABSO NET GRANULES



MULTI-ZORB Absorbant Granules
Inert Non-Flammable Clay Granules, for all Work Place Spillages
20ltr, 15kg Bag

Part No.	Price
895 293	£11.70

SAFETY TREAD GRANULES



New Safety Tread Absorbent Granules, Non Dusting
Remains Granular even when Saturated. Suitable for use on strong chemicals, 30ltr

Part No.	Price
865 180	£22.20

ABSORBENT PADS DOUBLE



Double Weight Absorbent Pads
Polly Wrapped Pack of 100
Pad size 38 x 49cm

Central Perforation for easy Tearing and Maximum Economy
Dimple-Bonded for Maximum Strength.

Part No.	Description	Price
934 1051	Oil & Fuel 100 Pack	£52.97
934 1043	General Purpose 100 Pack	£52.97

ABSORBENT PADS SINGLE



Single Weight Absorbent Pads
Polly Wrapped Pack of 200
Pad size 40 x 50cm

Central Perforation for easy Tearing and Maximum Economy
Dimple-Bonded for Maximum Strength.

Part No.	Description	Price
934 1056	Oil & Fuel 200 Pack	£81.70
934 1048	General Purpose 200 Pack	£85.20

ABSORBENT ROLL SINGLE



Single Weight Absorbent Pads
Polly Wrapped Pack of 200
Pad size 40 x 50cm
Central Perforation for easy Tearing and Maximum Economy
Dimple-Bonded for Maximum Strength.

Part No.	Type	Width	Price
934 1044	G/Purpose	38cm	£41.89
934 1052	Oil & Fuel	38cm	£36.09
934 1060	Chemical	38cm	£45.56
934 1046	G/Purpose	48cm	£50.32
934 1054	Oil & Fuel	48cm	£45.52
934 1062	Chemical	48cm	£57.55

ABSORBENT ROLL TWIN PACK

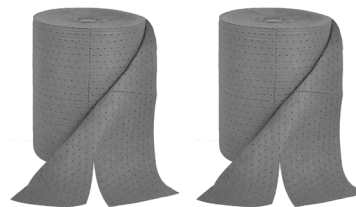

Absorbent Roll - Twin Pack
Ideal for Easy Clean-up of Everyday Spills and Leaks
Perforated for Easy Tearing
Dimple-Bonded for Maximum Strength.

Part No.	Type	Width	Price
934 1045	G/Purpose	38cm	£80.50
934 1053	Oil & Fuel	38cm	£70.74
934 1061	Chemical	38cm	£85.00
934 1047	G/Purpose	48cm	£94.30
934 1055	Oil & Fuel	48cm	£85.70
934 1063	Chemical	48cm	£108.30

Barrel Pumps & Accessories

BARREL PUMP 45 GALLON



Barrel Pump for 45 Gallon
(205 ltr) Drums

Hand Rotary Pump with
1" Outlet & 1m Riser Tube
2" Drum Connection

Part No.	Price
J1614	£23.00

BARREL PUMP 45 GALLON



Lever Action Drum Pump for 50
to 205 ltr Drums
Steel Pump Body, Delivery
Spout & Telescopic Suction Tube

0.45 ltr Delivery Per Stroke
(16 ltr Per Minute)
2" Drum Connection

Part No.	Price
635 252	£19.45

SMALL SYPHON PUMP



Small Barrel Syphon Pump
Fits 5 - 25 ltr Containers
21" Delivery hose
15" Suction hose

Part No.	Price
200 754	£4.10

LARGE SYPHON PUMP



Syphon Pump
Fits 205 ltr Containers
Threaded 2" BSPM
51" Delivery Hose
33 1/2" Suction Hose

Part No.	Price
200 753	£13.45

			
2" Drum/Barrel Tap High Density Polyethylene	3/4" BSP Lockable Brass Drum/Barrel Tap	3/4" BSP Lockable Plastic Drum/Barrel Tap	Aluminium Diecast Lockable Barrel Tap 3/4" BSP
812 440 £12.50	812 410 £9.95	812 430 £2.85	812 420 £9.50
			
2" Metal Barrel/Drum Plug	3/4" Metal Barrel/Drum Plug	Universal Plastic Drum Wrench	Self Closing Barrel Tap 3/4" BSP
200 233 £0.95	200 234 £0.90	200 247 £7.57	895 225 £11.78

Dispensing Equipment

BRASS FLANGED BACK NUTS



Brass Flanged Back Nut
BSP Thread

Part No.	Thread	Price
804 710	3/8" BSP	£1.15
804 720	1/2" BSP	£1.40
804 730	3/4" BSP	£1.70
804 740	1" BSP	£3.10

DRUM DOLLIES



Drum Dolly with 3" Castor
Wheels, 1 Braked

Part No.	Size	Price
A1044SE	Dolly for 180kg & 205ltr Drums	£77.50

TANK GAUGES



Tank Float Gauges
Suitable for Diesel Fuels,
Heating Oil, Lube Oils or Water
Provides a Simple Rough
Indication of Tank Content -
EMPTY ¼, ½, ¾ or FULL
Accuracy +/- 5% (approx)
Mounts Directly into the Top of
Tank (1.1/2" BSP Thread)

Part No.	Description	Price
812 451	4ft Deep Tanks	£17.75
812 452	5ft Deep Tanks	£22.11
812 450	6ft Deep Tanks	£20.50

FUNNEL WITH FLEXI SPOUT



Plastic 6" Funnel with Metal
Flexi Spout

Part No.	Price
J8055/10	£9.60

ROUND FUNNEL



Round Funnel
Diameter 90mm

Part No.	Price
J8055/3	£3.95

RECTANGULAR FUNNEL



Large Heavy-Duty Funnel
Made from High Density
Polyethylene
Size: 10" x 6.5"
Supplied with Water Separating
Metal Gauze Filter
Tapered Spout with Venting Ribs

Part No.	Price
J8055/12	£6.20

ROUND ANGLED FUNNEL



7" Round Funnel with
45 degree Angled Nozzle

Part No.	Price
866 200	£6.54

2-STROKE MIXING BOTTLE



For Accurate Measuring &
Mixing Of 2 Stroke Petrol/Oil
Mixture

Part No.	Price
804 200	£2.90

ROUND FUNNEL KIT



Set of 4 Round Funnels
50, 75, 100, 120mm Diam

Part No.	Price
895 065	£2.45

Dispensing Equipment

Steel Jerricans

Manufactured from 0.9mm sheet steel.
Patented cap locking system keeps the contents secure and the bayonet cap closure device ensures can is leakproof in any position.
Wide channel breather for smooth and steady pouring



Part No.	Description	Price
934 020	10 Litre - Green	£34.45
934 021	20 Litre - Green	£28.00
934 022	10 Litre - Red	£21.65
934 023	20 Litre - Red	£29.98
934 024	10 Litre - Black	£20.37
934 025	20 Litre - Black	£29.98

JERRICAN SPOUT



Jerrican Spout 6" to suit 10ltr & 20ltr Jerry Cans

Part No.	Price
200 759	£6.50

JERRICAN SEAL



Replacement Rubber Seal for Jerrican Spouts

Part No.	Price
200 751	£0.95

FLEXISPOUT OIL JUGS



Flexispout Oil Measuring Jug with Flexible Spout & Cap

Part No.	Size	Price
J8057/1N	1 Litre	£4.95
J8057/2N	2 Litre	£5.60
J8057/3N	3 Litre	£6.40
J8057/5N	5 Litre	£8.20

PLASTIC FUEL CANS



Plastic 5ltr Fuel Cans Complete with Flexi Spout

Part No.	Colour	Price
200 761	Green	£6.42
200 760	Red	£6.42
200 977	Black	£7.07

OIL MEASURES



Polyethylene Oil Measuring Jugs

Part No.	Size	Price
895 088	1.5 Litre	£5.60
895 089	5 Litre	£11.04

BRAIDED LEAK OFF PIPE



Cotton Overbraided Fuel Pipe Suitable for Diesel, Petrol & Oil
DIN SPEC 73379 TYPE B 1983
Working Pressure 150PSI (10 BAR)

Part No.	I/D	Length	Price
200 437	3.2mm	5m	£8.82
200 438	3.5mm	5m	£9.98
200 439	5mm	5m	£12.01
200 440	6mm	5m	£12.00
200 441	8mm	5m	£13.00
200 442	10mm	5m	£15.25

Mixer Conversion Kits & Generators



Mixer Conversion Kit - 2.5HP Engine

Convert your Belle Minimix 150 fitted with a Honda GXH50 Engine to a new Loncin LC152F 2.5HP Engine (based on Honda's G100 engine).

- Kit Includes:
- Loncin 2.5HP (97cc) Engine
 - Mounting Deck
 - Gearbox Pulley
 - Engine Pulley
 - Drive Belt & Guard



Part No.	Price
101 601	POA

Mixer Conversion Kit - 4.0HP Engine

Convert your Belle Minimix 150 fitted with a Honda GXH50 Engine to a new Loncin G120 4.0HP Engine (based on Honda's GX120 engine).

- Kit Includes:
- Loncin 4.0HP (118cc) Engine
 - Mounting Deck
 - Gearbox Pulley
 - Engine Pulley
 - Drive Belt & Guard



Part No.	Price
101 602	£242.00



1.8kW Suitcase Generator/Inverter

Portable, quiet & fuel efficient suitcase generator. Powered by a single cylinder 4-stroke engine. Can be synchronised with additional units.

- Specs:
- 1.8kW Max Output
 - 1.6 kW Rated Output
 - 230v AC Voltage at 50Hz
 - 12v DC Voltage
 - 8.3 Amps DC Current
 - Noise Level: 61dBA
 - Size: 499 x 285 x 455mm
 - Weight: 21kg



Part No.	Price
101 180	£557.00

2.2kW 110/230v Frame Generator

Long running 110/230v frame type generator. Powered by a single cylinder 196cc 4-stroke engine. Automatic voltage regulator.

- Specs:
- 2.2kW Max Output
 - 2.0 kW Rated Output
 - 110v / 230v AC Voltage
 - Charging Voltage 12v DC
 - 8.3 Amps DC Current
 - Noise Level: 75dBA
 - Size: 590 x 475 x 460mm
 - Weight: 43kg
 - 15 Hrs Run Time



Part No.	Price
101 200	£343.70



Loncin Spare Parts

We stock spare parts and service items for your Loncin Engine, Pump and Generator. Please contact us for details.



AdBlue

TRANSFER PUMP



AdBlue Transfer Pump

On/Off Switch
32L/min Flow Rate
IP55 Rated Protection

Part No.	Voltage	Price
304 012	12v	£287.20
304 013	240v	£233.90

ELECTRIC PUMP



Electric Mega Pump

19 Litres per Minute

Suitable for Diesel, Water, Kerosene, Antifreeze, Washer Fluid, Mild Detergents, Agricultural Chemicals and Light Oils

Part No.	Voltage	Price
J1403MP	12v/240v	£169.00

HAND PUMP



Hand Lever Action Pump

Flow Rate of 500cc's per stroke / 20 litres per Minute

Suitable for Water, Lubricants, Anti-freeze, Windshield Washer Fluid or Mild Detergents

Part No.	Flow Rate	Price
304 045	20L/min	£43.42

HOSE KIT



AdBlue Hose Kit

4 Metre Hose (3/4" Diameter) with Plastic Trigger Nozzle

Part No.	Price
800 500	£92.20

ADBLUE HOSE



3/4" Adblue Fuel Hose

Reinforced PVC Polyester Braid
I/D - 19mm
O/D - 28mm
BAR - 17
PSI - 105
GR/M - 584

Part No.	Length	Price
124 0337	8m	£46.59

TRIGGER NOZZLE



Plastic Trigger Nozzle

3/4" BSP
19mm Spout

Part No.	Price
J3040 NOZZ	£34.85

GREENCHEM



AdBlue Greenchem 10L

Especially designed additive, developed for diesel engines with a SCR system

Part No.	Price
304 014	£23.50

SPILL KIT



Includes highly absorbent socks and pads for efficient cleanup

Convenient disposable bags provided for easy disposal

Compliance with PPG 7 9.1 Emission Reduction Solutions (ERS) standards

Part No.	Type	Price
934 1304	25L Clip-Top Bag	£15.35
934 1305	50L Shoulder Bag	£60.55

13 Amp Plugs, Sockets & Adaptors

13 AMP PLUG - NYLON



White Nylon
3 Pin Domestic Plugs
13 amp

Part No.	Price
265 278	£1.50

13 AMP DOMESTIC PLUG



3 Pin Domestic Plug
13 amp, Black

Part No.	Price
200 069	£1.95

1 GANG TRAILING SOCKET



1 Gang Trailing Socket
13 amp. Insulated

Part No.	Price
265 264	£2.95

13 AMP HEAVY DUTY PLUG



3 Pin Heavy Duty Plug
13 amp, Black, Impact Resistant
Sleeved Pins, BS 1363/A

Part No.	Price
265 262	£2.10

4 GANG TRAILING SOCKET

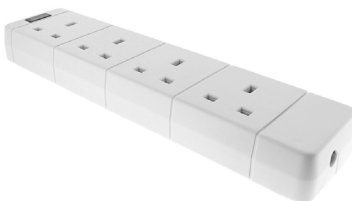

4 Gang Trailing Socket
13 amp. Insulated

Part No.	Price
265 275	£4.42

2 GANG TRAILING SOCKET



2 Gang Trailing Socket
13 amp. Insulated

Part No.	Price
265 276	£4.35

13 AMP CHECK PLUG



Classic Check Plug is a Quick & Easy Way to Ensure that 13 Amp Sockets are Wired Correctly.
High Brightness Neon Lights Indicate Faults

Part No.	Price
200 079	£14.17

3 WAY ADAPTOR



3 Pin 3-Way Fused Adaptor
13 amp

Part No.	Price
265 284	£9.60

DOMESTIC FUSES



Domestic Mains Plug Fuses
BS1362

Part No.	Description	Price
200 084	3 Amp Fuse	£0.16
200 085	5 Amp Fuse	£0.16
200 086	13 Amp Fuse	£0.16
110 266	100 Assorted Pack	£18.18

24 HOUR PLUG-IN TIMER



24 Hour 4 Segment Plug-in
Timer Switch with Manual
Override
13 amp

Part No.	Price
265 285	£14.67

RCD CIRCUIT BREAKER



Double Pole Circuit Breaker
Safeguard against Danger of
Electrocution from Severed or
Damaged Cables

Plug in Protection
Test/Reset
Approved to BS7071

Part No.	Price
200 090	£13.60

Extension Leads

1 GANG EXTENSION LEAD



1 Gang Extension Lead
13 amp 240v

Nylon Socket & 3 Pin
Mains Plug with 15 Metre Lead

Part No.	Price
200 249	£18.73

4 GANG EXTENSION LEAD



4 Gang Extension Lead
13 amp 240v

White Nylon Socket & 3 Pin
Mains Plug with 1 Metre Lead

Part No.	Price
295 277	£4.77

240V EXTENSION LEAD - 10M



10 Metre Extension Lead 240v
10 Amp

BS 5733 Approved Hand Winding
Reel with Four Sockets

Part No.	Price
FPPCR10M10A	£25.47

240V EXTENSION REEL - 25M



2 Gang Heavy Duty 25m
13 amp 240v Extension Reel

Ventilated Plastic Drum
3 Pin Mains Plug

Part No.	Price
265 289	£42.75

110V EXTENSION REEL - 25M



2 Gang Heavy Duty 25m
Extension Reel

Complete with 16 Amp, 110v
Plug & 16 Amp, 110v Double
Socket Plate

Part No.	Price
200 314	£55.83

110V EXTENSION LEADS



Includes 14m of 2.5mm² Yellow
Arctic Cable & 110v Trailing
Plug & Socket

Part No.	Description	Price
200 299	16 Amp	£26.33
200 273	32 Amp	£54.17

240V SINGLE FLY LEAD



240v 16Amp Plug to 240v
13 Amp Single UK Socket

1m Long Extension Lead

Part No.	Price
200 350	£7.90

240V DOUBLE FLY LEAD



240v 16Amp Plug to 240v
13 Amp Double UK Socket

1m Long Extension Lead

Part No.	Price
200 355	£8.95

240V MOULDED ADAPTOR



240 Volt 16Amp to 240 Volt
13 Amp Moulded Adaptor

Part No.	Price
200 081	£15.25

240V 4 WAY FLY LEAD



240v 16Amp Plug to 240v
13 Amp 4-Gang UK Socket
W
0.5m Long Extension Lead

Part No.	Price
200 357	£17.50

Electrical Cable

H07 BLACK RUBBER CABLE

Black Rubber 2 & 3 Core Cable - Tough Rubber Sheathed (TRS)

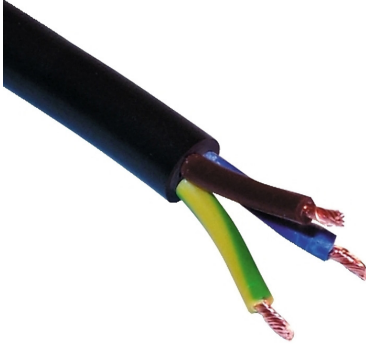

Size	Core	10m		25m		50m	
		Part No.	Price	Part No.	Price	Part No.	Price
1.0 mm ²	2 Core	124 0127	£12.48	124 0128	£30.00	124 0129	£49.33
	3 Core	124 0130	£15.18	124 0131	£32.24	124 0132	£60.42
1.5 mm ²	2 Core	124 0133	£11.77	124 0134	£29.42	124 0135	£55.50
	3 Core	124 0136	£15.62	124 0137	£39.04	124 0138	£73.67
2.5 mm ²	2 Core	124 0139	£17.35	124 0140	£43.37	124 0141	£81.83
	3 Core	124 0142	£21.69	124 0143	£57.33	124 0144	£103.80

3 CORE ARCTIC CABLE - BLUE & YELLOW

3 core arctic grade flexible cable, available for 110v (Yellow) & 240v (Blue) applications and available in 1.50mm² and 2.50mm² sizes.

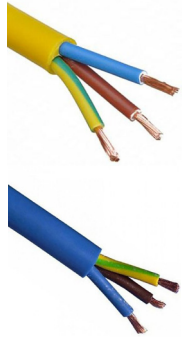

Voltage	Size	10m		50m		100m	
		Part No.	Price	Part No.	Price	Part No.	Price
110v (Yellow)	1.5mm ²	124 0145	£9.57	124 0146	£49.82	124 0147	£97.20
	2.5mm ²	124 0148	£16.39	124 0149	£81.97	124 0150	£152.00
240v (Blue)	1.5mm ²	124 0151	£10.12	124 0152	£50.62	124 0153	£91.70
	2.5mm ²	124 0154	£16.15	124 0155	£81.97	124 0156	£148.50

COPPER HT CABLE



Copper HT Cable
16/030

30m Roll

Part No.	Price
215 272	£29.58

WHITE PVC FLEX

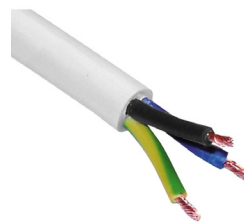

3 Core Flexible Mains Cable
PVC Covered

30m Rolls

Part No.	Size	Price
215 268	0.75mm ²	£49.09
215 269	1.00mm ²	£49.66
215 262	1.50mm ²	£58.60

ELECTRICAL SAFETY MATTING



Electrical Safety Rubber Matting

For use in front of open switchboards, high voltage equipment and many industrial plant and factories.

Sold per metre

Pallet charge applicable for lengths greater than 5 metres.

Part No.	Style	Details	Price P/M
866 102	No8	10mm x 1m	£43.50
866 103	Class 2	4.5mm x 1m	£46.28
866 104	Class 0	6mm x 1m	£40.13

CABLE CONNECTORS



Includes Male & Female Connector

Part No.	Type	Price
265 251	2 Pin	£4.95
265 252	3 Pin	£4.95

240V INLINE RCD ADAPTOR



13 Amp Domestic Plug to 240v
16 Amp Site Training Socket

Protected Inline with an RCD
Double Pole Circuit Breaker

Part No.	Price
200 040	£39.00

Auto Cable

1MM² SINGLE CORE CABLE



1mm² Single Core Auto Cable
14/030. 8.75 amp

50m Rolls

Part No.	Colour	Price
215 166	Red	£14.80
215 167	Black	£14.80
215 168	Blue	£14.80
215 169	Green	£14.80
215 170	Yellow	£14.80
215 171	Brown	£15.24
215 172	White	£14.80

1MM² TWIN CORE CABLE



1mm² Twin Core Auto Cable
2 x 14/030. 8.75 amp

30m Roll

Part No.	Price
124 0319	£21.77

2MM² TWIN CORE CABLE



2mm² Twin Core Auto Cable
2 x 28/030. 17.50 amp

30m Roll

Part No.	Price
215 183	£42.95

2MM² SINGLE CORE CABLE



2mm² Single Core Auto Cable
28/030. 17.50 amp

50m Rolls

Part No.	Colour	Price
215 173	Red	£25.48
215 174	Black	£25.48
215 175	Blue	£25.48
215 176	Green	£25.48
215 177	Yellow	£29.51
215 178	Brown	£25.48
215 179	White	£25.48

TWIN CORE SPEAKER CABLE



0.4mm² Twin Core Speaker
Cable, 2 x 44/030. 27.50 amp

100m Roll

Part No.	Price
215 184	£37.22

7 CORE TRAILER CABLE 10M ROLL



7 Core Trailer Cable For
Caravans and Trailers
Suitable for 12v Applications
10m Roll

Part No.	Price
124 0165	£16.50

3MM² SINGLE CORE CABLE



3mm² Single Core Auto Cable
44/030. 27.50 amp

30m Rolls

Part No.	Colour	Price
215 192	Black	£27.18
215 193	Brown	£26.43
215 180	Red	£27.25

7 CORE TRAILER CABLE 30M ROLL



Black PVC 7 Core Cable for
Trailers - 5.75 amp

30m Roll

Part No.	Price
215 221	£56.88

4.5MM² SINGLE CORE CABLE



4.5mm² Single Core Auto Cable
65/030. 35 amp

30m Roll - Red

Part No.	Price
215 181	£36.00

25MM² STARTER CABLE



25mm² Starter Cable - Light Duty
37/090. 12v Applications 170 Amp

10m Rolls

Part No.	Colour	Price
215 231	Red	£75.44
215 232	Black	£75.60

Site Electrical Connectors

110V CABLE PLUGS



Low Voltage Plug 110v
Yellow

Part No.	Size	Price
200 277	16 Amp	£2.95
200 278	32 Amp	£8.25

110V TRAILING SOCKETS



Low Voltage 110v Trailing Sockets
Yellow

Part No.	Size	Price
200 281	16 Amp	£4.73
200 282	32 Amp	£10.90

110V PANEL SOCKETS



Low Voltage 110v Straight Panel
Sockets c/w with Gasket
Yellow

Part No.	Size	Price
200 285	16 Amp	£4.75
200 286	32 Amp	£10.50

110V ANGLED SOCKETS



Low Voltage 110v 15° Angled
Panel Sockets c/w Gasket
Yellow

Part No.	Size	Price
510 304	16 Amp	£11.58
530 304	32 Amp	£23.29

240V CABLE PLUGS



240v Trailing Plugs
Blue

Part No.	Size	Price
200 279	16 Amp	£3.60
200 280	32 Amp	£9.55

240V TRAILING SOCKETS



240v Trailing Sockets
Blue

Part No.	Size	Price
200 283	16 Amp	£3.95
200 284	32 Amp	£11.45

240V PANEL SOCKETS



240v Straight Panel Sockets
complete with Gasket
Blue

Part No.	Size	Price
200 287	16 Amp	£4.58
200 288	32 Amp	£12.50

240V ANGLED SOCKETS



240v 15° Angled Panel Sockets
complete with Gasket
Blue

Part No.	Size	Price
510 306	16 Amp	£11.58
530 306	32 Amp	£18.68

110V 'BALS' PLUGS



110 Volt, 16 Amp 'BALS' Plugs
Yellow

Part No.	Description	Price
212 002	Plug	£2.83
212 001	Trailing Socket	£4.50

240V 'BALS' PLUGS



240 Volt, 16 Amp 'BALS' Plugs
Blue

Part No.	Description	Price
212 006	Plug	£2.85
212 005	Trailing Socket	£4.50

415V CABLE PLUG



415v/32 Amp 5 Pin Cable Plug
Red

Part No.	Price
200 390	£10.42

415V TRAILING SOCKET



415v/32 Amp 5 Pin Trailing Socket
Red

Part No.	Price
200 391	£13.25

Power Tool Transformers



Power Tool Transformers

3.3 kVA & 5 kVA Low Voltage Power Tool Transformers
Tough GRP Case (IP44 Rated), Low Temperature (Arctic) Cable
Input Voltage 230v AC, Output Voltage 110v AC
Resettable Circuit Breaker
Fitted with 13 Amp Plug

Part No.	Power	Sockets	Price
200 291	3 kVA	2 x 16 Amp	£76.50
200 315	5 kVA	2 x 16 Amp, 1 x 32 Amp	£192.00

REPLACEMENT LID



Replacement Lid for
3kVA Transformer

Part No.	Size	Price
200 075	3 kVA	£12.67

10 AMP CIRCUIT BREAKER



10 Amp Push Button Circuit
Breaker

Suitable for most Power Tool
Transformers

Part No.	Price
879 110	£4.75

SPLITTER BOX - 4 WAY



110v 4 Way Splitter Box
4 x 16 Amp 3 Pin Sockets
2.5mm Arctic Cable
Robust Painted Steel Case

BSEN 61242

Part No.	Price
200 091	£29.95

CABLE GLAND



Cable Gland suitable for most
Power Tool Transformers

Part No.	Price
994 008	£0.40

SPIDER BALL - 4 WAY



110v 4 Way Portable Distribution
Unit by Defender
4 x 16 Amp 3 Outlets
Tough, Stackable Casing

Part No.	Price
200 327	£52.49

110V CHECK PLUG



110V CT Industrial Check Plug
Invaluable for instantly checking
sockets in a factory or on site
installations
Fitted with a yellow 110V 16A
CT plug to BS4343/IEC309

Part No.	Price
200 077	£65.83

16AMP 3-WAY ADAPTORS



3-Way Socket Adaptors
Robust Moulded Plastic Body
16A 3 Pin Plug to Multi Coupler
BSEN 60309

Part No.	Type	Price
200 080	110v / Yellow	£18.40
200 082	240v / Blue	£16.50

240V CHECK PLUG



240V CT Industrial Check Plug
Fitted with a blue 240V
16A round 3-pin plug
to BS4343/IEC309

Part No.	Price
200 078	£64.31

Lighting

110V FESTOON KIT



22m 110v festoon site kit c/w
10 x BC lamp holders (ES
available on request) at 2m
spacings
6A 110v input plug (BSEN 60309)
10 x high grade yellow nylon
lamp guards (open frame)
3183YAG 2 core yellow
festoon cable

Part No.	Price
200 272	£76.89

500W SINGLE SITE LIGHT



Site Light Supplied with C class energy
saving halogen tubes, on a telescopic
stand that enables the lamp height to be
adjusted between 780mm and 1830mm
(31in and 72in).

Suitable for C class halogen tubes.

Part No.	Volt	Price
FPPSL500CT	240v	NLA
FPPSL500CTL	110v	£34.49

LI-ION LED WORK LIGHT



10W Lithium Ion Battery Powered
400 Lumen LED Work Light.

Light Spread: 120
IP Rating: IP44
Colour Temp: 6500K
Lamp: LED COB

Part No.	Price
790 352	£29.15

6500K LED TWIN SITE LIGHT



Twin DF4000 heads fitted to a robust
telescopic tripod (0.6m - 1.7m)
SMD LEDs deliver 6500k cool white light
Frosted shatterproof lens
Spotlight rotates through 360° and
locked in place.

Part No.	Volt	Price
200 341	230v	£115.80

64 LED/110V FLOOR LIGHT



Low Energy LED Floor Lamp
Polycarbonate lens & ABS body
64 Quality LED's
Rubber grip and base
IP44 rated
Supplied with 110v Plug

Part No.	Price
709 185	£39.40

50W LED FLOODLIGHT



Comes with wall bracket
SMD LED technology
6500k / 5200lm
Light across a 110° angle
Prewired power cable
IP65 Rated
Suitable for outdoor use
195 x 57 x 152mm

Part No.	Price
SEALED113	£29.95

FLUORESCENT FLOOR LIGHT



110V 38W Floor Lamp

Complete with energy saving 2D
fluorescent lamp, cable and plug

Equivalent to 150W incandescent

Part No.	Price
790 308	£12.56

50W LED FLOODLIGHT W/ PIR



Features a PIR motion detector
Comes with wall bracket
SMD LED technology
6000k / 4500lm
Light across a 110° angle
Supplied with power cable
Only suitable for outdoor mounting
IP44 Rated
210 x 30 x 260mm

Part No.	Price
SEALED113PIR	£39.95

Lighting

VISION SMD HAND & UV TORCH



Compact Hand Lamp & UV Torch
10W 1000 Lumen LED Lamp
3W UV torch offering 395 nm

USB charging lead, USB Charging Plug & Car Adaptor Included

Part No.	Price
275 521	£33.25

LED HEAD TORCH



3W COB LED spotlight
Adjustable inclination
200 lumens
high/low/flash settings
Adjustable headband & foam brow pad
Requires 3 x AAA batteries (not included)

Part No.	Description	Price
SEAHT101	Head Torch	£12.78
MN2400	4 x AAA Batteries	£3.15

LED INSPECTION LAMP



410Lm 15W Super Bright
LED COB

Rechargeable, comes with USB Cable & Plug, Dimmer Switch, Magnetic Swivel Base

Part No.	Price
069 970	£52.48

LED SWIVEL LIGHT & TORCH



LED Light & Torch
6 x 05w High Power SMD LED Lamp, Provides 3W/300 Lumen
Flexible Magnetic Base

USB Charging Plug & Car Adaptor Included

Part No.	Colour	Price
275 350	Yellow	£31.71
275 351	Orange	£29.92

RECHARGEABLE HEADLAMP



LED Headlamp
Super bright, wide-angle beam
3 output choices
Optional sensor operated mode
Adjustable head strap

Supplied with a USB Charger and USB Lead

Part No.	Price
L/HEHEAD150R	£26.00

LED ALUMINIUM TORCH



Weather resistant security torch
Precision engineered aluminum body
Complete with required batteries

Powered by 2 x AA batteries

Part No.	Description	Price
275 502	Torch	£9.94
MN1500	4 x AA Batteries	£3.30

WEATHERPROOF TORCH



General Purpose Torch
Weatherproof
Krypton Bulb
Includes a 6v Battery (996 type)

Part No.	Description	Price
275 334	Torch	£19.48
275 330	6v Battery	£3.94

VISION

Introducing The New Vision Lighting Range Compatible With The Latest Innovative Wireless Fast Charging Pads!

Find out more below...



Lighting

2D FLUORESCENT TUBE



4 Pin Square Recess (Gr10q)
Voltage: 240
Wattage: 28

(suitable for floor lamp 790 650)

Part No.	Price
295 275	£6.90

8W FLUORESCENT TUBE

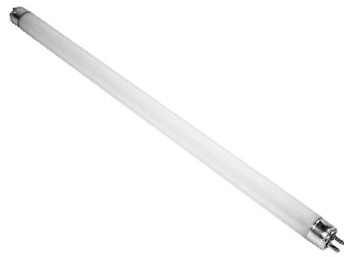

240v 8w Single Fluorescent Tube

(suitable for inspection lamp
295 321)

Part No.	Price
295 320	NLA

STARTER SWITCHES



Fluorescent Light
Starter Switches

Part No.	Wattage	Price
295 301	4 - 80W	£0.40
295 302	100 - 125W	£1.00

LANTERN BATTERY



6 Volt Lantern Battery
Size/Type 996

Part No.	Price
275 330	£3.94

LED LIGHT BULBS



Discover more on our website including LED, Halogen, Fluorescent and WIFI light bulbs. Choose from a variety of bulb shapes, including GU10, G4 & G9, ES & SES, BC and spotlight. Available in a range of wattages, colour temperatures, dimmable options and with long-lasting life spans.

Part No.	Description	Fitting	lm / W	Dimmable	Colour	Price
ENGS8826	Energizer 36°	GU10	345 lm / 5.5W	Yes	Warm White	£4.30
ENGS8827	Energizer 36°	GU10	360 lm / 5.5W	Yes	Cool White	£4.30
ENGS8823	Energizer 36°	GU10	350 lm / 5W	No	Warm White	£2.86
ENGS8825	Energizer 36°	GU10	370 lm / 5W	No	Cool White	£2.74
ENGS8832	Energizer 36°	MR16/GU5.3	345 lm / 4.8W	No	Warm White	£4.02
ENGS8833	Energizer 36°	MR16/GU5.3	360 lm / 4.8W	No	Cool White	£4.02
ENGS8099	Energizer HIGHTECH	G4	200 lm / 2.2W	No	Warm White	£5.46
FPPSLBA6010W	Faithfull A60 110-240V	ES	800 lm / 10W	No	Daylight	£3.78
ENGS12852	Energizer GLS	ES	806 lm / 7.2W	Yes	Warm White	£5.74
ENGS9423	Energizer Opal	ES	806 lm / 9.2W	Yes	Warm White	£7.90
ENGS12856	Energizer Candle	SES	450 lm / 4.5W	Yes	Warm White	£4.74
SEALED061	Sealey 10W/230V B22	BC	810 lm / 9W	No	Daylight	NLA
ENGS12851	Energizer GLS / B22	BC	806 lm / 7.2W	Yes	Warm White	£5.74
ENGS12855	Energizer Candle / B22	BC	470 lm / 5W	Yes	Warm White	£4.74
ENGS9420	Energizer Opal / B22	BC	806 lm / 9.2W	Yes	Warm White	£7.90
LTHE279W	Wi-Fi Opal GLS	ES	800 lm / 9W	Yes	White + RGB	£17.45
LTHE145W	Wi-Fi Candle	SES	400 lm / 5W	Yes	White + RGB	£17.85
LTHB229W	Wi-Fi Opal GLS	BC	800 lm / 9W	Yes	White + RGB	£17.45
LTHGU105W	Wi-Fi	GU10	345 lm / 5W	Yes	White + RGB	£16.78

Batteries & Capacitors

DURACELL BATTERIES



DURACELL Alkaline Batteries
The Original Copper Top Battery

Long Life - Outlasts Zinc Carbon Batteries 3:1

DURACELL

Part No.	Type	Size	Volts	Pack	Price
MN1500	LR6	AA	1.5v	4	£3.30
MN2400	LR03	AAA	1.5v	4	£3.15
MN1400	LR14	C	1.5v	2	£3.10
MN1300	LR20	D	1.5v	2	£3.80
MN1203	3LR	-	4.5v	1	£4.80
MN1604	6LR61	PP3	9v	1	£3.40

LITHIUM CELL BATTERIES



Lithium Cell Batteries for Remote Controls and Small Electrical Equipment

Part No.	Type	Size	Volts	Price
275 101	CR1616	1.5 x 16mm	3v	£1.93
275 102	CR2016	1.6 x 20mm	3v	£1.64
275 103	CR2025	2.5 x 20mm	3v	£1.53
275 104	CR2032	3.2 x 20mm	3v	£1.70
275 105	CR1220	2 x 12.5mm	3v	£1.67
275 106	CR1620	2 x 16mm	3v	£1.70
275 111	LR44	5 x 11.5mm	1.5v	£0.96
275 112	23A	28 x 10mm	12v	£1.30

CAMERA BATTERIES



3v Camera Batteries

DURACELL

Part No.	Type	Volts	Price
275 107	CR123	3v	£5.55
275 108	CR2	3v	£7.13

CIRCUIT BREAKERS



Push Button Circuit Breaker for DC or AC Circuits

Complete with Lock Nut

Part No.	Current	Price
879 104	4 Amp	£4.75
879 110	10 Amp	£4.75
879 125	13 Amp	£4.75
879 115	15 Amp	£4.75
879 118	18 Amp	£4.75
879 120	20 Amp	£4.75
879 130	30 Amp	£4.75
879 135	35 Amp	£4.75
879 175	Waterproof Cap	£1.40

CAPACITORS



Capacitors/Condensers

Applications Include: Pressure Washers, Tower Lights, Shredders, Cement Mixers etc.

Part No.	Capacitance	Power Range	Price
231 570	6µF	500-600W	£5.10
231 564	8µF	700-800W	£5.40
231 565	10µF	900-1000W	£6.10
231 566	12µF	1100-1200W	£6.06
231 567	16µF	1300-1600W	£5.24
231 569	20µF	1700-2000W	£8.50
231 571	25µF	2000-2500W	£8.90
231 572	30µF	2600-3000W	£9.50
231 573	50µF	4600-5000W	£15.50

CHANGEOVER SWITCH



Generator Changeover Switch 110V/240V

6 Terminal Switch

Part No.	Price
879 500	£7.90

GENERATOR MOUNTS

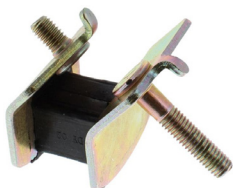

Vibration Mounts suitable for Mounting Generators and Pumps onto Frames

Part No.	Height	Stud	Price
890 170	30mm	8mm Male / 8mm Male	£2.18
890 180	40mm	8mm Male / 8mm Male	£3.20

GENERATOR FRAME



Generator Frame Up To 3.2kVA 600 x 450 x 415mm High

Use with rubber mounts:
1 x VM2
2 x 890 170

Part No.	Price
200 685	£75.58

Electrical Accessories

INSULATION TAPE



High Quality, Flame Retardant
PVC Insulation Tape to BS3924

20m Rolls

Part No.	Colour	Width	Price
225 279	Black	19mm	£0.65
225 288	Black	50mm	£2.27
225 290	Grey	19mm	£0.83
225 281	Red	19mm	£0.82
225 282	Blue	19mm	£0.83
225 283	Green	19mm	£0.83
225 284	Yellow	19mm	£0.83
225 285	White	19mm	£0.82
225 286	Brown	19mm	£0.83
225 287	Green/Yellow	19mm	£0.83
225 280	Assorted Pack of 10 Rolls/ 19mm		£8.10

CABLE TIES



High Quality, PVC Cable Ties
Various Colours & Sizes

Part No.	Size	Colour	Pack	Price
245 187	2.5 x 100mm	Black	100	£0.95
245 186	2.5 x 100mm	White	200	£1.76
245 189	3.6 x 140mm	Black	100	£1.85
245 188	3.6 x 140mm	White	100	£2.66
245 304	4.8 x 120mm	Black	100	£2.05
245 303	4.8 x 120mm	White	100	£3.10
245 191	4.8 x 200mm	Black	100	£2.67
245 190	4.8 x 200mm	White	100	£3.15
245 310	4.8 x 300mm	Black	100	£3.95
245 309	4.8 x 270mm	White	100	£5.37
245 302	4.8 x 370mm	Black	100	£4.95
245 185	4.8 x 370mm	White	100	£7.78
245 313	4.8 x 200mm	Red	100	£3.70
245 314	4.8 x 200mm	Blue	100	£3.70
245 315	4.8 x 200mm	Yellow	100	£3.70
245 316	4.8 x 200mm	Green	100	£3.70
245 193	7.6 x 300mm	Black	100	£4.75
245 192	7.6 x 300mm	White	100	£6.98
245 195	7.6 x 370mm	Black	100	£6.95
245 194	7.6 x 370mm	White	100	£12.00
245 204	9.0 x 780mm	Black	100	£19.95
245 306	13.0 x 560mm	Black	50	£14.00
245 305	13.0 x 560mm	White	50	£14.00
245 200	4.8 x 370mm	Silver	1	£0.30
245 318	4.8 x 370mm	Silver	100	£4.95
245 201	Assorted	Black	200	£9.45
245 205	4.8 x 200mm	Assorted	100	£4.25

PLASTIC CABLE CLIPS



Self Adhesive
Plastic Cable Clips

Part No.	Cable Ø	Pack	Price
255 198	6.0mm	100	£7.12
255 199	11.5mm	50	£5.65
255 200	16.0mm	25	£4.28

NYLON 'P' CLIPS



Black Nylon P-Clips

Part No.	Cable Ø	Pack	Price
255 288	5.0mm	100	£5.00
255 289	6.4mm	100	£5.52
255 290	8.0mm	100	£8.58
255 291	12.0mm	100	£8.70
110 100	Assorted Pack of 100 Clips		£7.10

CABLE TIE BASES



Cable Tie Bases

Packs of 50

Part No.	Up To Width	Price
245 196	3.5mm	£3.41
245 197	4.7mm	£5.80

Electrical Accessories

ADJUSTABLE P-CLIPS



Adjustable White
Nylon P-Clips

Part No.	Cable Ø	Pack	Price
255 295	6.4 - 9.5mm	50	£12.04
255 296	9.5 - 14.3mm	50	£12.25
255 297	14.3 - 22.2mm	50	£13.91
255 298	22.2 - 30.2mm	50	£20.38

TERMINAL BLOCKS



Terminal Blocks
12 Per Strip

Part No.	Amps	Price
205 215	3 Amp	£0.50
205 216	5 Amp	£0.50
205 217	15 Amp	£0.90
205 218	30 Amp	£1.45

HEAT SHRINK TUBING



Black Heat Shrink Tubing
Polyolefin. Shrink Ratio of 2:1

Part No.	Diameter	Roll Length	Price
205 401	3.2mm	10m	£6.60
205 404	4.8mm	10m	£7.78
205 407	6.4mm	10m	£9.60

HEAT SHRINK TUBING



Assorted Box of 30 x 200mm
Lengths. Various Colours.

Diameters:
4.8, 6.4, 9.5mm (Black, Blue,
Red, Yellow), 12.7mm (Black,
Red, Yellow)

Part No.	Price
105 181	£8.44

WIRING GROMMETS



Rubber Wiring (Cable) Grommets
Assorted Pack

Sizes:
6.4 x 4.75mm to 16.0 x 12.5mm

Part No.	Price
110 168	£10.20

HEAT SHRINK TUBING



Assorted Box of 160 x 50 & 70mm
Lengths. Various Colours.

Diameter x Length: 3.2 x 50,
4.8 x 50, 12.7 x 70mm (Black,
Blue, Red, Yellow)

Part No.	Price
105 186	£10.65

BLANKING GROMMETS



Rubber Blanking Grommets
Assorted Pack

Fits Hole Sizes:
8.0, 9.5, 12.5, 16.3, 19.0, 25.4mm

Part No.	Price
110 103	£15.23

CABLE CLIPS - FLAT



Plastic Nail Fixing
Flat Cable Clips
Complete with Nail

Part No.	Cable Ø	Pack	Price
255 114	6mm	100	£3.30
255 115	9mm	100	NLA
255 116	10mm	100	£3.12

Electrical Accessories

PVC SPIRAL CONDUIT



PVC Flexible Spiral Conduit
Temp range : -20°C to +70°C
5 metre lengths
IP65 Rating - Not Split

Part No.	I/D	O/D	Price
992 200	12mm	16mm	£6.05
992 210	16mm	20mm	£6.95
992 220	20mm	25mm	£7.60

SPIRAL WRAP

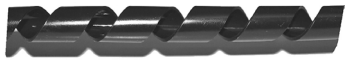

Spiral Wrap
Made from black polythene
Temp range -60°C to +90°C
5m Lengths

Part No.	Bundle Ø	Price
124 0335	5 - 50mm	£2.10
124 0336	9 - 100mm	£4.75

CONDUIT OPENER



Enables the User to Bundle
Cable Quickly & Effortlessly

Part No.	Suits Conduit	Price
990 100	10 - 18mm	£2.27
990 200	21 - 28mm	£2.50

EMERGENCY STOP BUTTON



Push Button Operated
Single Pole
Normally Closed
IP65 Rated

Part No.	Price
065 701	£57.95

3 BUTTON CONTROL BOX



Three Spring Return Buttons
Single Pole
2 Normally Open & 1 Normally
Closed Contacts
IP65 Rated

Part No.	Price
065 703	£83.00

PVC SPLIT CONDUIT



Black Nylon Tubing
Temp range : -25°C to +125°C
Flame Retardant

Part No.	I/D	O/D	Length	Price
124 0324	10mm	13mm	5m	£10.50
124 0325	11mm	16mm	5m	£4.79
124 0326	14mm	18mm	5m	£8.05
124 0327	16mm	21mm	5m	£11.67
124 0328	21mm	25mm	5m	£10.25

NYLON SWIVEL GLANDS



Nylon Swivel Gland
with Locknut
Screws onto PVC Spiral
Conduit

Part No.	Fits Conduit Ø	Price
994 222 EA	16mm	£1.00
994 226	20mm	£1.10
994 228	25mm	£1.35

NYLON CABLE GLANDS



Plastic Cable Gland with
Locknut
IP68 Rated
BS EN 50262:1999

Part No.	Cable Ø	Thread	Price
994 002	5 - 10mm	16mm	£0.50
994 006	6 - 12mm	20mm	£0.52
994 008	10 - 14mm	20mm	£0.40
994 112	13 - 18mm	25mm	£1.26

HOIST CONTROL SWITCH



Pistol Grip Control Switch
For Control Of Single-speed
Hoist Motors, 2 Single Pole,
Normally Open Contacts
IP65 Rated

Part No.	Price
065 700	£99.40

Gas Hose & Connectors

High Performance Gas Hose

High Performance Gas Hose to BS3212/2
High Pressure Hose for use at all pressures up to 17.5 bar



Part No.	Bore Ø	Length	Price
124 0043	4.8mm (3/16")	5m	£11.25
124 0044	4.8mm (3/16")	25m	£55.00
124 0045	4.8mm (3/16")	50m	£105.00
124 0046	6.0mm (1/4")	5m	£10.50
124 0047	6.0mm (1/4")	25m	£51.00
124 0048	6.0mm (1/4")	50m	£95.00
124 0049	8.0mm (5/16")	5m	£11.00
124 0050	8.0mm (5/16")	25m	£57.82
124 0051	8.0mm (5/16")	50m	£111.10

ARMOURED GAS HOSE



High Performance Galvanised
Overbraided Gas Hose to
BS3212/2

For use at all pressures
up to 17.5bar

Part No.	Bore Ø	Length	Price
124 0052	4.8mm (3/16")	2m	£18.80
124 0053	4.8mm (3/16")	10m	£85.00
124 0054	4.8mm (3/16")	25m	£205.00
124 0055	8.0mm (5/16")	2m	£16.54
124 0056	8.0mm (5/16")	10m	£82.68
124 0057	8.0mm (5/16")	25m	£200.20

5MTR GAS HOSE WITH NUTS



8mm Gas Hose c/w Female
3/8" BSP Fittings

Length: 5 metres

Part No.	Price
300 850	£16.17

MALE HOSE CONNECTORS



Gas Hose Connector 1/4"
Male BSP Taper Thread to
Hose Tail

Part No.	Hose Tail	Price
JL1121	4.8mm	£3.30
JL1114	8.0mm	£4.12

4MTR ARMOURD GAS HOSE



4.8mm Armoured Gas Hose
c/w Female 3/8" BSP Fittings
Length: 4 metres

Part No.	Price
200 013	£30.83

O-CLIPS



O Clips
Zinc Plated

Part No.	Suits Gas Hose	Price (ea)
505 140	4.8mm & 6mm	£0.23
505 141	8.0mm	£0.20

FEMALE HOSE CONNECTORS

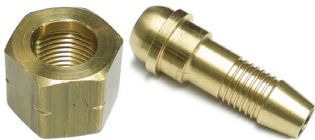

Gas Hose Connectors
3/8" BSP Female Union
(left hand thread) to Hose Tail

Part No.	Hose Tail	Price
JL1021	4.8mm	£3.80
JL1022	6.3mm	£2.75
JL1023	8.0mm	£2.75

PROPANE PIGTAIL ASSEMBLY



750mm Pigtail Assembly
Assembled & Ready for Use

Part No.	Price
JL1495	£16.90

PROPANE MANIFOLD



Can be used with Pigtail
to Connect 2 Propane
Cylinders to Improve Supply

Part No.	Price
JL1506	£20.05

Regulators

HIGH PRESSURE - PRESET

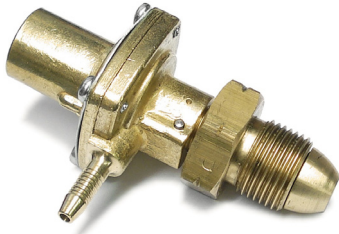

Bullfinch 'Tinyreg 2' Preset Regulators To BS3016
Fixed 4.8mm Outlet

(Propane Regulator Pictured)

Bullfinch

Part No.	Type	Output	Price
JL1041	Propane	1 bar	£33.13
JL4041	Propane	4 bar	£40.45

HIGH PRESSURE - VARIABLE



Propane Regulator
Operating Range: 0 - 4 bar

Suitable for Tar Burners & Blowtorches

Part No.	Type	Output	Price
200 012	Propane	0 - 4 bar	£15.50

HIGH PRESSURE - VARIABLE

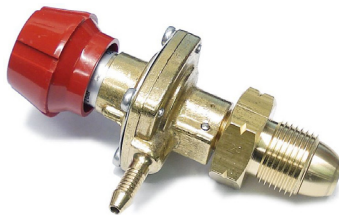

Bullfinch 'Tinyreg 2' Variable Regulators To BS3016
Fixed 4.8mm Outlet

Bullfinch

Part No.	Type	Output	Price
JL1051/01	Propane	0.35 - 1 bar	£38.56
JL1051	Propane	0.35 - 2 bar	£37.47

LOW PRESSURE - PROPANE



A Reg 14 Low Pressure Propane Regulator - Preset 37 mbar

Capacity: 1.5kg/h (21kW)

BS3016

Part No.	Type	Outlet	Output	Price
200 426	Propane	Fixed (8mm)	37 mbar	£8.93

HIGH PRESSURE - VARIABLE

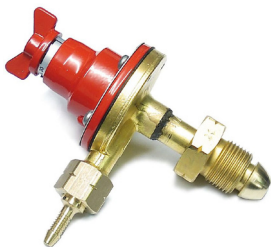

High volume compact regulator for propane. Ideal for appliances with a high throughput such as forced air heaters, bitumen boilers etc.

77kW with 4.8mm bore hose
87kW with 6.3 or 8mm hose when operated at 1 bar

Bullfinch

Part No.	Type	Output	Price
JL1465X	Propane	0.35 - 1 bar	NLA

LOW PRESSURE - PROPANE

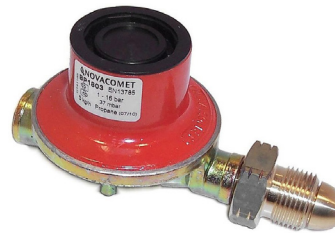

A Reg 14 Low Pressure Propane Regulator - Preset 37 mbar
Equivalent to Calor 766P

Capacity: 4kg/h (55kW)

8mm hose tail outlet sold separately

Part No.	Description	Outlet	Output	Price
200 795	Propane Reg	3/8" Female	37 mbar	NLA
200 7951	3/8" Hose Tail	8mm	-	£2.49

HIGH PRESSURE - VARIABLE



Calibrated Propane Regulator
Output: 0.35 - 1 bar
Capacity: 2 - 6kg/h

Suitable for Space Heaters up to 190,000 Btu

Part No.	Type	Output	Price
200 794	Propane	0.35 - 1 bar	£33.05

LOW PRESSURE - BUTANE



634 A Reg
Compact Low Pressure Butane Clip On Regulators

Fixed Outlet: 8mm
Outlet Pressure: 29 mbar

Part No.	Type	Inlet	Output	Price
200 424	Butane	21mm	29 mbar	£7.45

Propane Torch Kits

STANDARD TORCH KIT



Kit Contains:
1 x JL1340 Handle
1 x JL1230 Burner
1 x JL1051 Tinyreg Variable Regulator
2.75m (9ft) Gas Hose

Bullfinch

PLUMBERS TORCH KIT



Kit Contains:
Plastic Handle
Burner Nozzle
Variable 0-4 bar Propane Regulator
8mm x 5m Gas Hose

Part No.	Price
JL140P	£96.90

Part No.	Price
202 000	£54.17

BRAZING BURNER



Bullfinch 4104 Autotorch Brazing Burner No. 4104 - Medium flame (For smaller flame use a smaller burner)

Must be used at 4 bar (should not be turned down)

Bullfinch

TORCH HANDLE



Bullfinch 1185 Torch Handle

With Comfortable Nylon Handle - Strong Enough to Withstand Rough Usage

Bullfinch

Part No.	Price
JL4104	£41.35

Part No.	Price
JL1185	£36.22

BULLFINCH BURNER HEADS



For use with Bullfinch Propane Torches & Blowtorches

High Pressure (0.35 - 2 bar)

Bullfinch

TORCH HANDLE



Bullfinch 1340 Torch Handle

Extra Strong Steel Spring Handle to Withstand the Toughest Contractor Usage

Bullfinch

Part No.	Burner I/D	Output	Price
JL1230	23mm	4.5kW	£20.51
JL1240	30mm	8.4kW	£23.98
JL1250	35mm	12.6kW	£24.39
JL1260	45mm	19.6kW	£28.54
JL1270	60mm	32.5kW	£32.21
JL1125	Replacement Gasket		£0.81

Part No.	Price
JL1340	£36.29

GAS LEAK DETECT SPRAY



Gas Leak Detection Spray
Non Flammable

400ml Aerosol

Part No.	Price
200 969	£3.25

Blowtorch Kits

SINGLE BLOWTORCH KIT



Kit contains:
1 x 60mm Burner Head
5 mtrs x 4.8mm H.P Gas Hose
Extended Handle
Variable Regulator 0-4 bar

Part No.	Price
300 810	£64.95

TWIN BLOWTORCH KIT



Kit contains:
2 x 45mm Burner Head
5 mtrs x 4.8mm H.P Gas Hose
Extended Handle
Twin Adaptor
Variable Regulator 0-4 bar

Part No.	Price
300 820	£89.00

TRIPLE BLOWTORCH KIT



Kit contains:
3 x JL1270 Burner Heads
3 mtrs x 4.8mm H.P Gas Hose
Extended Handle
Trident Adaptor
Variable 1051 Regulator
0-2 bar

Part No.	Price
200 420	£238.20

Bullfinch

4-WAY BLOWTORCH KIT



Kit contains:
4 x 45mm Burner Heads
5 mtrs x 4.8mm H.P Gas Hose
Extended Handle
Quad Adaptor
Variable Regulator 0-4 bar

Part No.	Price
300 840	£99.75

PROPANE BURNER HEADS



High Pressure Burner Heads
For use with Single, Twin &
Four Way Blowtorches
(does not fit Bullfinch kit)

Part No.	Burner Ø	Price
300 845	45mm	£18.90
300 860	60mm	£19.90

BLOWTORCH ADAPTORS



Multi-Head Adaptors
For use with Single, Twin &
Four Way Blowtorches
(does not fit Bullfinch kit)

Part No.	Type	Price
300 865	2 Way Adapter	£27.85
300 875	4 Way Adapter	£29.95

EXTENSION PIPE



580mm Handle Extension
For use with Single, Twin &
Four Way Blowtorches
(does not fit Bullfinch kit)

Part No.	Price
300 870	£17.23

BLOWTORCH HANDLE



Blowtorch Handle Only
For use with Single, Twin &
Four Way Blowtorches
(does not fit Bullfinch kit)

Part No.	Price
300 815	£22.05

Gas Equipment

EXTENDED HANDLE



1060mm Extended Blowtorch Handle

For use with Bullfinch Burners & Adaptors

Bullfinch

Part No.	Price
JL1345	£78.83

BULLFINCH ADAPTORS



Blowtorch Adaptors

Fits Bullfinch Burners & Extension Tubes

Bullfinch

Part No.	Description	Price
JL1122	Twin Adaptor	£64.17
JL1123	Triple Adaptor	£64.16

PROPANE BOILING RINGS



Boiling Ring Kits for Propane
Ideal for Canteen Use (not suitable for boiling tar)
Output: 10.55kW
Kit Contains:

- Boiling Ring
- 3m x 8mm Gas Hose
- A Reg 14 Regulator
- 2 x Hose Clips

Part No.	Size	Price
200 002	Small (230 x 250mm)	£60.08
200 001	Large (570 x 400mm)	£79.95

BULLFINCH EXTENSION TUBES



Extension Tubes

Fits Between Bullfinch Handle & Burner (or Adaptor)

Bullfinch

Part No.	Length	Price
JL1112	305mm (12")	£24.01
JL1124	610mm (24")	£28.39
JL1140	1020mm (40")	£38.97

PROPANE TROLLEY HEATER



Twin Propane Trolley Heater
Outputs: 2.8kW or 5.6kW

Complete with Gas Hose & 37 mbar regulator

(gas bottle not included)

Bullfinch

Part No.	Price
200 792	£411.00

BULLFINCH SINGLE FURNACE



Bullfinch 1365 Single Furnace
Ideal for melting lead and other metals, compounds, bitumen, etc.

Heats compounds to about 600°C

Use with JL1051/01 Regulator

Bullfinch

Part No.	Price
JL1365	£200.90

XGSC1 SITE HEATER



Highly Efficient Heater for LPG
Atmosphere Sensing Pilot
Flame Failure Device
Fitted with 2m of Gas Hose & Regulator
Turn Down Valve from 4kW to 2.6kW
CE Marked

Part No.	Price
LP14-2	£79.95

Gas Equipment

BULLFINCH 1400 HEATER



Portable Space Heater for a wide variety of needs for building sites, road works, outbuildings, railways, public utilities, farms etc.

Heat Input: 25kW at 1 bar

(Hose & Regulator Kit not included)

Part No.	Price
JL1400	£385.00

Bullfinch

1400 HOSE & REGULATOR KIT



Bullfinch 4m Hose & 1051/1 Regulator Kit to suit Bullfinch 1400 Space Heater

Part No.	Price
JL1401	£49.58

Bullfinch

BULLFINCH 1400 SPARES

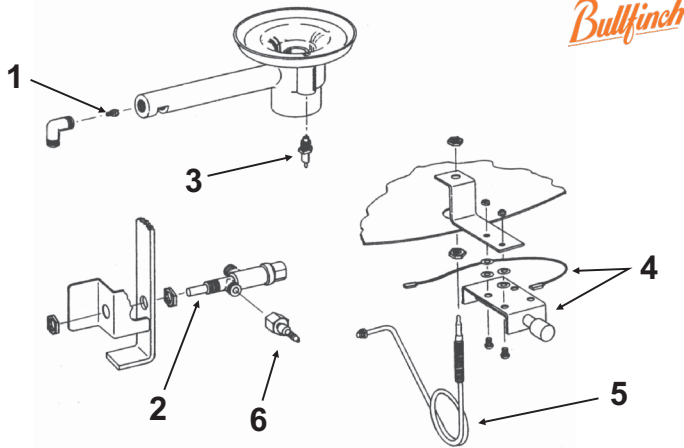

Bullfinch

1200HL HEATER SPARES

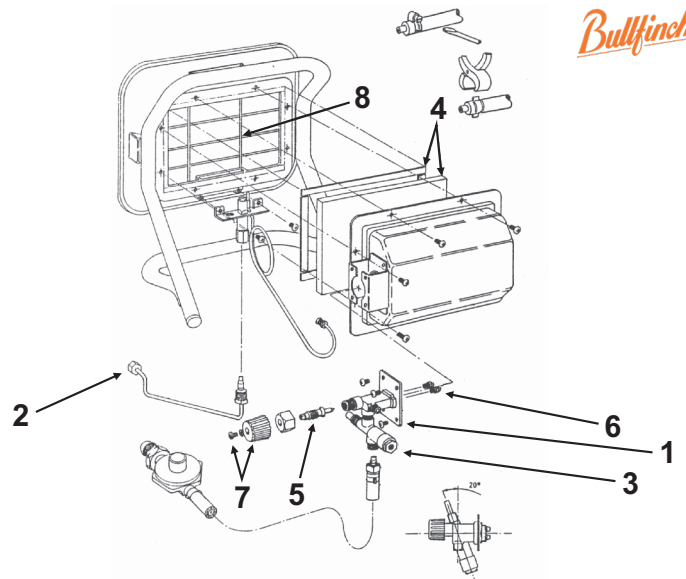

Bullfinch

Part No.	Fig.	Description	Price
SP170	1	Jet	£1.96
SP1400CN	2	Flame Supervision Device	£27.45
SP1500C	3	Spark Plug	£17.05
SP1400BD	4	Ignitor & Lead	£19.27
SP1400BA	5	Thermocouple	£5.97
SP1400BX	6	Hose Connector Assy	£4.91
SP1400BE	2 & 5	Flame Device/Thermocouple	£29.61

Part No.	Fig.	Description	Price
SP1200GK	1	Heat Control Assy	£35.10
SP1200GT	2	Pilot Tube Assy	£21.05
NLA	3	Flame Supervision Device	-
SP1200DM	4	Radiant Plaque Kit	£22.00
NLA	5	Valve Needle Kit	-
SP1203X	6	Gas Jet (pack of 2)	£1.35
SP100B	7	Valve Knob Kit	£1.10
SP5204U	8	Guard Kit	£5.55

GAS LIGHT MANTLES



Replacement Gas Mantles

Price per pack of 2

Bullfinch

GLASS BOWL - 1616 LANTERN



Glass Bowl for Bullfinch 1616 Gas Lantern

Outer Dimension: 120mm
Height: 85mm

Increasingly fragile

Bullfinch

Part No.	Suits	Price
JL1228	1225 MiniFlood	NLA
JL1617	1616 Handlight	NLA

Part No.	Description	Price
JL1618	Spare Glass Bowl	£17.33

Gas Equipment

HI-PRO GAS CYLINDER 2PK



Propylene Gas Cylinder - Pack of 2
400 grams of gas
CGA 600 connection (1in x 20
UNEF)
270mm tall x 75mm diameter

Conforms to EN12205

Part No.	Price
JL1694/02	£19.50

HI-PRO GAS CYLINDER 6PK



Propylene Gas Cylinder - Pack of 6
400 grams of gas
CGA 600 connection (1in x 20
UNEF)
270mm tall x 75mm diameter

Conforms to EN12205

Part No.	Price
JL1694/06	£56.95

PROPANE CYLINDER 2PK



Propane Gas Cylinder - Pack of 2
400 grams of gas
CGA 600 connection (1in x 20
UNEF)
270mm tall x 75mm diameter

Suitable for Sahara Mini BBQs
Conforms to EN12205

Part No.	Price
JL1644/02	£18.33

PROPANE CYLINDER 6PK



Propane Gas Cylinder - Pack of 6
400 grams of gas
CGA 600 connection (1in x 20
UNEF)
270mm tall x 75mm diameter

Suitable for Sahara Mini BBQs
Conforms to EN12205

Part No.	Price
JL1644/06	£53.95

FIREPOWER/HI-PRO GAS KIT



Propylene Gas Cylinder and Fire-
Power Torch Kit

400 grams of gas
CGA 600 connection (1in x 20
UNEF)

Conforms to EN12205

Part No.	Price
JL394	£54.76

FIREPOWER/PROPANE GAS KIT



Propane Gas Cylinder and Fire-
Power Torch Kit

400 grams of gas
CGA 600 connection (1in x 20
UNEF)

Conforms to EN12205

Part No.	Price
JL364	£53.05

FIREPOWER TORCH CGA600



Spark ignition torch for CGA600
connections

Piezo ignition
Ignition button lock for continuous
use
Long reach body

Part No.	Price
JL3640	£45.49

LEAK DETECTING KIT 120ML



Leak Detecting Kit

Specially formulated fluid with
brush applicator

120ml Bottle

Part No.	Price
JL550	£5.71

Gas & Tar - Gas and tar products available from leading professional brands on our Website.



SIEVERT[®]
Heating tools for professionals

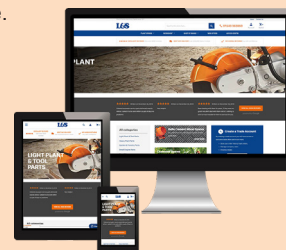

www.lsengineers.co.uk

Tar Equipment



Tar Boiler Kits

Tar Boiler Kits complete with Burner, Armoured Hose, 0-4 Bar Regulator, Pouring Bucket & Long Handle Ladle.

3 Day (Palleted) Delivery Only

Price Includes Delivery to UK Mainland Address

Part No.	Description	Price
200 009	10 Gallon	£460.00
625 023	10 Gallon with Tap	£525.00
200 124	15 Gallon	£566.00
625 024	15 Gallon with Tap	£525.00
200 125	25 Gallon	£649.00
625 025	25 Gallon with Tap	£679.50
625 040	40 Gallon	£403.00
625 045	40 Gallon with Tap	£470.00

TAR BOILER LIDS

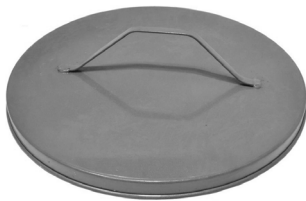

Replacement Tar Boiler Lids

Part No.	Description	Dia.	Price
200 903	10 Gallon	16.1/2"	£32.62
200 904	15 Gallon	21"	£33.57

HEAVY DUTY BURNER



Heavy Duty Tar Burner for 10, 15 & 25 Gallon Tar Boilers

Part No.	Price
200 010	£104.00

0-4 BAR REGULATOR



Propane Regulator
Operating Range: 0 - 4 bar
Suitable for Heavy Duty Tar Burner

Part No.	Type	Output	Price
200 012	Propane	0 - 4 bar	£15.50

JET & WHISTLE WASHER



Jet & Whistle Washer for Heavy Duty Tar Burner

Part No.	Price
200 886	£5.90

PROPANE WALL BRACKETS



Wall Brackets to Secure Propane Bottles

Part No.	Size	No. Cylinders	Price
200 1022	77cm x 40cm	2	£34.33
200 1023	70cm x 40cm	2	£31.76

4MTR ARMOURED GAS HOSE



4.8mm Armoured Gas Hose c/w Female 3/8" BSP Fittings Recommended for Tar Boilers Length: 4 metres

Part No.	Price
200 013	£30.83

PROPANE BOTTLE TROLLEY



Propane Gas Bottle Trolley
Takes 1 x 46kg Cylinder

Part No.	Price
200 992	£91.40

GAS SPANNERS



Part No.	Type	Price
JL250	Bullfinch Combination	£5.13
200 435	Heavy Duty Propane	£8.95

Tar Equipment

HEAVY DUTY TAR BUCKET



Thick Mild Steel Fabricated Tar Bucket
Suitable for use directly on Boiling Rings

Part No.	Price
200 021	£49.47

V LIPPED TAR BUCKET



V Lipped Galvanised Tar Bucket with Tipping Handle
Heavy gauge - 3 Gallon Capacity

Part No.	Price
200 003	£33.55

LONG REACH TAR LADLE



Long Reach Tar Ladle
Pot Size:
Width 7 1/2" x Deep 4 1/4"
Handle Length: 22"

Part No.	Price
200 011	£25.00

TARMAC TAMPER



Square Head with Tubular Steel Handle
Size: 4.5kg (10lb)

Part No.	Price
200 036	£38.72

TARMAC RAKE



Tarmac Rake - 16 Round Teeth
Wooden Handle

Part No.	Price
200 034	£37.08

SHORT HANDLE TAR BRUSH



Short Black Fibre Tarmac Brushe with Short Wooden Handle

Part No.	Price
200 005	£2.36

TARMAC JUTE SHEETS



Tarmac Jute Sheets
Environmentally Friendly Tarpaulin for Covering and Keeping Tarmac Warm. Includes Ropes and Eyelets

Part No.	Size	Price
203 1209	12' x 9'	£33.12
203 1509	15' x 9'	£40.85
203 1512	15' x 12'	£54.17
203 1809	18' x 9'	£59.87
203 1812	18' x 12'	£64.55
203 2212	22' x 12'	£81.18
203 2418	24' x 18'	£106.15

BITUMEN POURING BUCKET



Galvanised Bitumen Pouring Can. Heavy Gauge - 3 Gallon Capacity
Hooped Bottom with Wide Spout

Part No.	Price
200 004	£40.50

TAR SPREADER/SPAZZLE



Tar Spreader/Spazzle
Metal or Wooden Head
Wooden Handle
Head: 610mm x 100mm

Part No.	Description	Price
200 035	Wooden Head	£19.00
200 121	Metal Head	£43.34

GAS BURNER FOR ROAD WORK



Sievert Pro88 Titanium Hand Held Gas Burner for Melting, Drying & Welding of Asphalt

SIEVERT		
Part No.	Description	Price
200 7887	50mm - 86kW	£122.70
200 7886	60mm - 114kW	£158.30
200 7888	70mm - 155kW	£155.90

Tools

COMBINATION SPANNERS



High Torque Metric Combination Spanners
Chrome Vanadium Steel
Hardened, Tempered & Chrome Plated. 15° Offset Jaw

Part No.	Size	Price
902 0001	6mm	£2.88
902 0002	7mm	£3.02
902 0003	8mm	£3.17
902 0004	9mm	£3.25
902 0005	10mm	£3.10
902 0006	11mm	£3.92
902 0007	12mm	£3.95
902 0008	13mm	£3.47
902 0009	14mm	£4.60
902 0010	15mm	£4.53
902 0011	16mm	£5.58
902 0012	17mm	£5.78
902 0013	18mm	£5.90
902 0014	19mm	£6.77
902 0015	20mm	£7.52
902 0016	21mm	£6.63
902 0017	22mm	£11.40
902 0018	23mm	£9.53
902 0019	24mm	£10.37
902 0020	27mm	£10.18
902 0021	30mm	£14.88
902 0022	32mm	£19.40

OPEN ENDED SPANNERS



Open Ended Spanner
Black Phosphate Finish
Single Ended

Part No.	Size	Price
902 0040	10mm	£2.05
902 0041	13mm	£1.95
902 0042	17mm	£2.75
902 0054	18mm	£2.95
902 0043	19mm	£2.85
902 0045	22mm	£3.10
902 0047	24mm	£3.60
902 0048	27mm	£3.80
902 0049	30mm	£5.30
902 0050	32mm	£5.50
902 0051	36mm	£9.00
902 0052	38mm	£9.37
902 0053	50mm	£26.50

BAHCO ADJUSTABLE WRENCH



Exceeds ISO Specifications
Withstands High Torque Loads
Heat Treated Swedish V Steel Jaws



Part No.	Size	Jaw Width	Price
902 0060	4"	13mm	£32.45
902 0061	6"	20mm	£34.33
902 0062	8"	27mm	£37.38
902 0063	10"	30mm	£48.43
902 0064	12"	34mm	£70.53
902 0065	18"	53mm	£165.30

SPANNER SET (STUBBY)



10 Piece Combination Spanner Set - Metric
Sizes:
4.0, 4.5, 5.0, 5.5, 6.0, 7.0, 8.0, 9.0, 10.0 and 11.0mm

Part No.	Price
902 0030	£17.67

METRIC SPANNER SET



11 Piece Combination Spanner Set - Metric

Sizes:
6, 7, 8, 9, 10, 11, 12, 13, 14, 17 and 19mm

Part No.	Price
902 0031	£18.25

IMPERIAL SPANNER SET



11 Piece Combination Spanner Set - Imperial

Sizes:
1/4, 5/16, 3/8, 7/16, 1/2, 9/16, 5/8, 11/16, 3/4, 13/16 & 7/8" AF

Part No.	Price
902 0032	£31.68

Tools



IRWIN
Record

Record Stillson Wrenches

Record stillsons are standard equipment in a wide range of major industries. Drop forged handle and jaws with high grade cast malleable iron frame. Accurately machined screw threads and nut with sprung jaw which stays open until pressure is applied.

Conforms to BS 3594 Part 1

Part No.	Size	Jaw Width	Price
902 0070	8"	19mm	£34.62
902 0071	10"	25mm	£43.17
902 0072	12"	32mm	£48.18
902 0073	14"	38mm	£52.65
902 0074	18"	51mm	£76.48
902 0075	24"	63mm	£140.00
902 0076	36"	89mm	£269.40

STILLSON PATTERN WRENCH



Forged from High Quality, Heat Treated Steel
Hardened Adjustment Nut
Dual Coil Springs

BLADE/PLUG SPANNERS



Combination Bolt/Plug
Box Spanners

Screwdriver End

Part No.	Size	Jaw Width	Price
902 0080	8"	27mm	£13.73
902 0081	10"	34mm	£19.73
902 0082	12"	42mm	£20.45
902 0083	14"	51mm	£24.72
902 0084	18"	60mm	£31.75
902 0085	24"	75mm	£54.31

Part No.	Size	Price
902 1360	17/19mm	£1.00
902 1361	13/19mm	£1.10
902 1362	17/21mm	NLA
902 1363	13/17mm	£1.10

Please See our Website for Special Offers and Promotions - www.lsengineers.co.uk



Bahco Socket Set 1/4" Drive

25 Piece Socket Set Includes:
1/4" Drive Ratchet
4, 4.5, 5, 5.5 and 6 to 13mm Sockets
1/4" Torx, Hex & Pozi Bits
Extension Bar



Part No.	Price
BAHSL25	£43.33



Bahco Socket Set 1/4" & 3/8" Drive

34 Piece Socket Set Includes:
1/4" Spinner Handle & 3/8" Drive Ratchet
10, 11, 12, 13, 14, 15, 16, 17, 18, 19,
20 & 22mm 3/8" Sockets
1/4" Torx, Hex & Pozi Bits
2 x Extension Bars



Part No.	Price
902 0091	£80.00



Bahco Socket Set 1/2" Drive

24 Piece Socket Set Includes:
1/2" Drive Ratchet
10, 11, 12, 13, 14, 15, 16, 17, 18, 19, 20,
21, 22, 23, 24, 27, 30 & 32mm Sockets
2 x Extension Bars
Universal Joint



Part No.	Price
902 0092	£124.80

Tools

CHROME VANADIUM SOCKETS



Expert Quality 6 & 12 Point
Chrome Vanadium Steel
Hardened, Tempered.

Part No.	Size	Drive	Point	Price
902 0099	5mm	1/4"	6	£2.04
902 0100	5.5mm	1/4"	6	£2.04
902 0101	6mm	1/4"	6	£2.04
902 0102	7mm	1/4"	6	£2.04
902 0103	8mm	1/4"	6	£2.04
902 0104	10mm	1/4"	6	£1.76
902 0105	12mm	1/4"	6	£2.04
902 0106	13mm	1/4"	6	£2.04
902 0107	6mm	3/8"	12	£2.11
902 0108	7mm	3/8"	12	£2.11
902 0109	8mm	3/8"	12	£2.11
902 0110	9mm	3/8"	12	£2.11
902 0111	10mm	3/8"	12	£2.11
902 0112	11mm	3/8"	12	£2.11
902 0113	12mm	3/8"	12	£2.11
902 0114	13mm	3/8"	12	£2.11
902 0115	14mm	3/8"	12	£2.11
902 0116	15mm	3/8"	12	£2.11
902 0117	16mm	3/8"	12	£2.65
902 0118	17mm	3/8"	12	£2.67
902 0119	18mm	3/8"	12	£2.67
902 0120	19mm	3/8"	12	£2.67
902 0121	22mm	3/8"	12	£3.02
902 0122	8mm	1/2"	12	£2.93
902 0123	9mm	1/2"	12	£2.93
902 0124	10mm	1/2"	12	£2.93
902 0125	11mm	1/2"	12	£2.93
902 0126	12mm	1/2"	12	£2.93
902 0127	13mm	1/2"	12	£2.93
902 0128	14mm	1/2"	12	£2.93
902 0129	15mm	1/2"	12	£2.93
902 0130	16mm	1/2"	12	£2.93
902 0131	17mm	1/2"	12	£3.45
902 0132	18mm	1/2"	12	£3.45
902 0133	19mm	1/2"	12	£3.45
902 0134	20mm	1/2"	12	£4.12
902 0135	21mm	1/2"	12	£4.12
902 0136	22mm	1/2"	12	£4.12
902 0137	23mm	1/2"	12	£4.12
902 0138	24mm	1/2"	12	£4.12
902 0139	25mm	1/2"	12	£5.50
902 0140	26mm	1/2"	12	£5.50
902 0141	27mm	1/2"	12	£5.50
902 0142	28mm	1/2"	12	£5.50
902 0143	30mm	1/2"	12	£5.78
902 0144	32mm	1/2"	12	£6.45
902 0145	36mm	1/2"	12	£12.03

DEEP SOCKETS



Expert Quality
Chrome Vanadium Steel
Hardened, Tempered

Part No.	Size	Drive	Point	Price
902 0150	7mm	1/4"	6	£2.93
902 0151	8mm	1/4"	6	£2.93
902 0152	13mm	1/4"	6	£2.93
902 0153	8mm	3/8"	12	£4.12
902 0154	10mm	3/8"	12	£4.12
902 0155	13mm	3/8"	12	£4.12
902 0156	17mm	3/8"	12	£4.60
902 0157	19mm	3/8"	12	£4.92
902 0158	10mm	1/2"	12	£5.50
902 0159	13mm	1/2"	12	£5.50
902 0160	17mm	1/2"	12	£4.82
902 0161	19mm	1/2"	12	£5.22
902 0162	24mm	1/2"	12	£6.30

SPARK PLUG SOCKETS



Spark Plug Sockets
Expert Quality
Chrome Vanadium Steel
Hardened, Tempered

Part No.	Size	Drive	Point	Price
902 0170	10mm	3/8"	6	£4.75
902 0171	12mm	3/8"	6	£4.78
902 0172	14mm	3/8"	6	£4.78
902 0173	10mm	1/2"	6	£5.38
902 0174	12mm	1/2"	6	£4.82
902 0175	14mm	1/2"	6	£4.82

Tools

EXTENSION BARS



Expert Quality
Chrome Vanadium Steel

Part No.	Size	Drive	Price
902 0180	50mm	1/4"	£2.50
902 0181	75mm	1/4"	£2.93
902 0182	150mm	1/4"	£4.78
902 0183	75mm	3/8"	£4.03
902 0184	150mm	3/8"	£4.63
902 0185	200mm	3/8"	£6.13
902 0186	75mm	1/2"	£5.58
902 0187	125mm	1/2"	£6.62
902 0188	250mm	1/2"	£8.13
902 0189	100mm	3/4"	£14.77
902 0190	200mm	3/4"	£21.25
902 0191	400mm	3/4"	£31.07

RATCHET DRIVES



Chrome Vanadium
Quick Release
Flip Reverse

Part No.	Fig.	Size	Price
902 0210	1	1/4" Drive	£8.52
902 0211	1	3/8" Drive	£18.42
902 0212	1	1/2" Drive	£27.43
902 0213	2	3/4" Drive	£54.92

FLEXI HANDLE



Expert Quality
Chrome Vanadium Steel

Part No.	Drive	Length	Price
902 0215	1/4"	130mm	£9.27
902 0216	3/8"	200mm	£12.52
902 0217	1/2"	250mm	£15.00
902 0218	1/2"	600mm	£22.59
902 0219	3/4"	475mm	£44.50

UNIVERSAL JOINTS



Expert Quality
Chrome Vanadium Steel

Part No.	Drive	Price
902 0195	1/4"	£5.93
902 0196	3/8"	£7.63
902 0197	1/2"	£10.17
902 0230	3/4"	£33.92

SLIDING TEE BAR



Expert Quality
Chrome Vanadium Steel

Part No.	Drive	Price
902 0220	1/4"	£6.13
902 0221	3/8"	£6.61
902 0222	1/2"	£12.20
902 0223	3/4"	£27.75

DRIVE CONVERTERS



Expert Quality
Chrome Vanadium Steel

Part No.	Female	Male	Price
902 0200	1/4"	3/8"	£4.23
902 0201	3/8"	1/4"	£3.72
902 0202	3/8"	1/2"	£5.07
902 0203	1/2"	3/8"	£5.38
902 0204	1/2"	3/4"	£12.00
902 0205	3/4"	1/2"	£13.18

DRIVE RAILS



For Wall Mounting Drive
Sockets

Part No.	Drive	Price
902 0225	1/4"	£4.49
902 0226	3/8"	£4.63
902 0227	1/2"	£5.10

Tools

HEX SOCKET BITS - 1/2" DRIVE

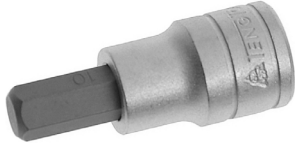

1/2" Drive Socket with Hexagon Bit
Expert Quality
Hardened & Forged S2 Silicon Steel

Part No.	Size	Drive	Price
902 0235	5mm	1/2"	£8.25
902 0236	6mm	1/2"	£8.25
902 0237	7mm	1/2"	£8.25
902 0238	8mm	1/2"	£8.25
902 0239	9mm	1/2"	£8.25
902 0240	10mm	1/2"	£8.67
902 0241	12mm	1/2"	£4.40
902 0242	14mm	1/2"	£11.33
902 0243	17mm	1/2"	£13.83
902 0244	19mm	1/2"	£4.98

DEEP IMPACT SOCKETS



Deep Drive Impact Sockets
1/2" & 3/4" Drive
Expert Quality
Drop Forged
Black Oxide Finish

Part No.	Size	Drive	Price
902 0280	10mm	1/2"	£4.00
902 0281	12mm	1/2"	£4.00
902 0282	13mm	1/2"	£4.20
902 0283	14mm	1/2"	£4.20
902 0284	15mm	1/2"	£4.20
902 0285	16mm	1/2"	£4.20
902 0286	17mm	1/2"	£4.92
902 0287	18mm	1/2"	£4.92
902 0288	19mm	1/2"	£4.10
902 0289	21mm	1/2"	£5.07
902 0290	22mm	1/2"	£5.07
902 0291	24mm	1/2"	£6.05
902 0292	27mm	1/2"	£7.25
902 0293	30mm	1/2"	£8.72
902 0294	32mm	1/2"	£9.82
902 0302	22mm	3/4"	£17.40
902 0295	24mm	3/4"	£14.25
902 0296	27mm	3/4"	£14.25
902 0303	28mm	3/4"	£14.80
902 0297	30mm	3/4"	£15.20
902 0298	32mm	3/4"	£15.20
902 0299	33mm	3/4"	£15.20
902 0300	34mm	3/4"	£15.87
902 0301	36mm	3/4"	£16.62

IMPACT SOCKETS



Drive Impact Sockets
1/2" & 3/4" Drive
Expert Quality
Drop Forged
Black Oxide Finish

Part No.	Size	Drive	Price
902 0250	10mm	1/2"	£2.70
902 0251	12mm	1/2"	£2.70
902 0252	13mm	1/2"	£3.28
902 0253	14mm	1/2"	£3.28
902 0254	15mm	1/2"	£3.28
902 0255	16mm	1/2"	£3.28
902 0256	17mm	1/2"	£3.37
902 0257	18mm	1/2"	£3.37
902 0258	19mm	1/2"	£3.37
902 0259	21mm	1/2"	£3.65
902 0260	22mm	1/2"	£3.65
902 0261	24mm	1/2"	£4.00
902 0262	27mm	1/2"	£4.95
902 0263	30mm	1/2"	£6.73
902 0264	19mm	3/4"	£9.67
902 0265	22mm	3/4"	£9.67
902 0266	24mm	3/4"	£9.67
902 0267	27mm	3/4"	£9.67
902 0268	28mm	3/4"	£10.22
902 0269	30mm	3/4"	£10.62
902 0270	32mm	3/4"	£10.62
902 0271	33mm	3/4"	£10.62
902 0272	34mm	3/4"	£12.20
902 0273	36mm	3/4"	£12.20
902 0274	41mm	3/4"	£13.65

IMPACT SOCKET ADAPTORS



Drive Adaptors (not impact reducing) & Extension Bars

Other Sizes Available - Please Contact Us

Part No.	Description	Price
902 0310	1/2" Female to 3/8" Male Adaptor	£5.53
902 0311	1/2" Female to 3/4" Male Adaptor	£8.62
902 0312	3/4" Female to 1/2" Male Adaptor	£13.58
902 0313	3/4" Female to 1" Male Adaptor	£17.77
902 0314	1" Female to 3/4" Male Adaptor	£21.37

Tools

T HANDLE SOCKET WRENCHES



T Handled Socket Wrench
Ideal for Honda Engines &
Husqvarna Saws

Part No.	Size	Price
902 0321	8mm x 185mm	£5.69
902 0322	10mm x 230mm	£9.32

HEX ALLEN KEYS - METRIC



Hexagon Short Arm Allen Keys
Metric Sizes

Part No.	Size	Price
902 0370	1.5mm	£0.15
902 0371	2mm	£0.15
902 0372	2.5mm	£0.15
902 0373	3mm	£0.15
902 0374	4mm	£0.25
902 0375	5mm	£0.25
902 0376	6mm	£0.29
902 0377	8mm	£0.68
902 0378	10mm	£0.97
902 0379	12mm	£2.75
902 0380	14mm	£2.88
902 0381	17mm	£6.20
902 0382	19mm	£5.95
902 0383	22mm	£9.34
902 0384	24mm	£18.18
902 0385	27mm	£30.55
902 0386	32mm	£43.81

T-BAR ALLEN KEYS



T Handled Hexagon Allen Keys
Ball Ended

Part No.	Size	Price
902 0355	2mm	NLA
902 0357	3mm	£3.69
902 0358	4mm	£3.62
902 0359	5mm	£4.35
902 0360	6mm	£4.43
902 0361	8mm	£4.75
902 0362	10mm	£5.58

HEX ALLEN KEYS - IMPERIAL



Hexagon Short Arm Allen Keys
Imperial Sizes

(Long arm Allen Keys available to order)

Part No.	Size	Price
902 0330	1/16"	£0.15
902 0331	5/64"	£0.15
902 0332	3/32"	£0.15
902 0333	7/64"	£0.15
902 0334	1/8"	£0.25
902 0335	9/64"	£0.25
902 0336	5/32"	£0.25
902 0337	3/16"	£0.30
902 0338	7/32"	£0.35
902 0339	1/4"	£0.35
902 0340	5/16"	£0.50
902 0341	3/8"	£0.87
902 0342	7/16"	£1.50
902 0343	1/2"	£2.01
902 0344	9/16"	£2.60
902 0345	5/8"	£4.28
902 0346	3/4"	£6.30
902 0347	7/8"	£9.60
902 0348	1"	£15.75

ALLEN KEY SET - METRIC



9 Piece Short Arm Allen Key
Set - Metric Sizes

Sizes:
1.5mm, 2mm, 2.5mm, 3mm
4mm, 5mm, 6mm, 8mm & 10mm

Part No.	Price
902 0390	£7.57

BALL END ALLEN KEY SET



9 Piece Long Arm Ball Ended
Allen Key Set - Metric Sizes

Sizes:
1.5, 2, 2.5, 3, 4, 5, 6, 8, & 10mm

Part No.	Price
902 0391	£15.25

Tools

HEX KEY SET - IMPERIAL & METRIC

25-Piece Metric and Imperial Hex Key Wrench Set



Metric Sizes:
1.0, 1.5, 2, 2.5, 3, 4, 4.5, 5, 5.5, 6, 7, 8 & 10mm

Imperial Sizes:
3/64, 1/16, 5/64, 3/32, 7/64, 1/8, 9/64, 5/32, 3/16, 7/32, 1/4 & 3/8in

Part No.	Price
B/S15307	£7.85

BALL END ALLEN KEY SET

13 Piece Long Arm Ball End Allen Key Set - Imperial Sizes

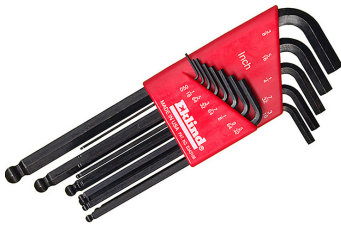

Sizes:
1/16" - 3/8" Imperial

Part No.	Price
902 0394	£19.30

T-HANDLE ALLEN KEY SET

8 Piece T Handle Allen Key Set
6" Handle, Cushion Grip



Sizes:
3/32", 7/64", 1/8", 9/64", 5/32"
3/16", 7/32" & 1/4"

Part No.	Price
902 0396	£16.58

STIHL TORX DRIVERS

T Handled Torx Wrench for
Stihl Screws



STIHL

Part No.	Length	Price
5910 890 2400	150mm	£3.10
5910 890 2415	200mm	£3.76

POZI INSERT BITS

S2 Modified Tool Steel
Grey Phosphate Coated

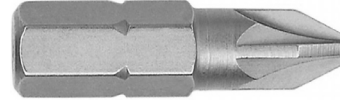

Part No.	Size	Length	Pack	Price
902 0400	Pozi 1	25mm	2	£1.31
902 0401	Pozi 2	25mm	2	£1.45
902 0402	Pozi 3	25mm	2	£1.31
902 0404	Pozi 1	25mm	10	£5.45
902 0405	Pozi 2	25mm	10	£4.82
902 0406	Pozi 3	25mm	10	£5.45
902 0407	Pozi 1	25mm	100	£32.88
902 0408	Pozi 2	25mm	100	£28.95
902 0409	Pozi 3	25mm	100	£32.88
902 0410	Pozi 1	50mm	1	£1.36
902 0411	Pozi 2	50mm	1	£1.36
902 0412	Pozi 3	50mm	5	£4.85
902 0413	Pozi 2	100mm	1	£2.73
902 0414	Pozi 2	150mm	1	£3.83
902 0415	Pozi 2	300mm	1	£12.45
902 0416	Pozi 1	50mm	5	£6.10
902 0417	Pozi 2	50mm	5	£6.10
902 0418	Pozi 2	50mm	50	NLA

TORX INSERT BITS

S2 Modified Tool Steel
Grey Phosphate Coated



Part No.	Size	Length	Pack	Price
902 0426	Torx 10	25mm	10	£6.00
902 0427	Torx 15	25mm	10	£6.00
902 0428	Torx 20	25mm	10	£6.00
902 0429	Torx 25	25mm	10	£6.00
902 0430	Torx 30	25mm	10	£6.00
902 0431	Torx 40	25mm	10	£5.40
902 0432	Torx 30	25mm	100	£54.05

Tools

PHILLIPS INSERT BITS



S2 Modified Tool Steel
Grey Phosphate Coated

Part No.	Size	Length	Pack	Price
902 0440	PH 1	25mm	2	£1.31
902 0441	PH 2	25mm	2	£1.45
902 0442	PH 3	25mm	2	NLA
902 0444	PH 1	25mm	10	£5.65
902 0445	PH 2	25mm	10	£5.45
902 0446	PH 3	25mm	10	£5.45
902 0448	PH 1	50mm	1	NLA
902 0449	PH 2	50mm	5	£4.85
902 0450	PH 3	50mm	1	£4.85
902 0451	PH 2	100mm	1	£2.73
902 0452	PH 2	150mm	1	£3.83
902 0453	PH 2	300mm	1	NLA
902 0454	PH 1	50mm	10	£1.32
902 0455	PH 2	50mm	10	£6.58
902 0456	PH 3	50mm	5	£5.80
902 0457	PH 2	50mm	50	£32.88

SLOTTED INSERT BITS



S2 Modified Tool Steel
Grey Phosphate Coated

Part No.	Size (mm)	Length	Pack	Price
902 0474	5.5 x 0.8	25mm	2	£1.76
902 0475	6.0 x 1.0	25mm	2	£1.76
902 0476	7.0 x 1.2	25mm	2	£1.76
902 0478	10.0 x 1.6	25mm	2	£2.68

MAGNETIC ADAPTORS



Professional Magnetic
Screwdriver Bit Adaptors

Part No.	Length	Pack	Price
902 0480	60mm	1	£4.02
902 0481	60mm	20	£57.63
902 0482	150mm	1	£7.63
902 0483	300mm	1	£18.43

HEXAGONAL INSERT BITS



S2 Modified Tool Steel
Grey Phosphate Coated

Part No.	Size (mm)	Length	Pack	Price
902 0460	3	25mm	2	£1.76
902 0461	4	25mm	2	£1.76
902 0462	5	25mm	2	£1.50
902 0463	6	25mm	2	£1.76
902 0464	8	25mm	2	£2.33

QUICK RELEASE ADAPTORS



Professional Quick
Release Magnetic
Screwdriver Bit Adaptors

Part No.	Length	Pack	Price
902 0485	60mm	1	£6.87
902 0486	60mm	20	£98.00
902 0487	150mm	1	£9.83
902 0488	300mm	1	£20.27

SQUARE INSERT BIT

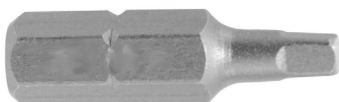

S2 Modified Tool Steel
Grey Phosphate Coated

Part No.	Size	Length	Pack	Price
902 0468	No. 2	25mm	2	£1.80

SDS PLUS ADAPTOR



Professional SDS Plus
Magnetic Screwdriver Bit
Adaptors

Part No.	Length	Pack	Price
902 0490	80mm	1	£8.75

Tools

SOCKET DRIVERS



For Driving Tek & ACME Screws

Part No.	Size	Length	Pack	Price
902 0496	5/16"	65mm	1	£3.33
902 0497	11mm Bi Hex	65mm	1	£7.17

BAHCO 31 PIECE BIT SET



31 Piece Set Includes
Pozi, Phillips, Slim Phillips
Torx, Slotted & Hex Bits
1/4" Magnetic Bit Holder



Part No.	Price
902 0535	£13.87

SCREWDRIVERS - SLOTTED



Chrome Vanadium Tip
Soft Grip Handle
Parallel Slotted Tip

STANLEY

Part No.	Tip Size	Length	Price
902 0500	2.5mm	50mm	£3.62
902 0501	3.0mm	50mm	£4.03
902 0502	3.0mm	100mm	£4.65
902 0503	3.0mm	150mm	£5.08
902 0504	3.5mm	75mm	£4.35
902 0505	4.0mm	100mm	£5.08
902 0506	4.0mm	150mm	£5.08
902 0507	5.5mm	150mm	£6.23
902 0508	6.5mm	150mm	£7.97
902 0509	6.5mm	30mm Stubby	£5.82

SCREWDRIVERS - POZI



Chrome Vanadium Tip
Soft Grip Handle
Pozi driv Tip

STANLEY

Part No.	Tip Size	Length	Price
902 0540	Pozi 0	75mm	£5.08
902 0541	Pozi 1	100mm	£5.82
902 0542	Pozi 1	250mm	£7.28
902 0543	Pozi 2	125mm	£7.28
902 0544	Pozi 2	250mm	£8.72
902 0545	Pozi 3	150mm	£8.72
902 0546	Pozi 4	200mm	£11.63
902 0547	Pozi 1	30mm Stubby	£4.35
902 0548	Pozi 2	30mm Stubby	£5.82

SCREWDRIVERS - PHILLIPS



Chrome Vanadium Tip
Soft Grip Handle
Phillips Tip

STANLEY

Part No.	Tip Size	Length	Price
902 0520	PH 00	50mm	£4.78
902 0521	PH 0	75mm	£5.08
902 0522	PH 1	100mm	£5.82
902 0523	PH 2	125mm	£7.97
902 0524	PH 2	250mm	£8.72
902 0525	PH 3	150mm	£8.72
902 0526	PH 4	200mm	£11.63
902 0528	PH 2	30mm Stubby	£5.82

7 PIECE SCREWDRIVER SET



3 x Pozi: PZ0, PZ1, PZ2
2 x Parallel: 3mm, 3.5mm
2 x Flared: 5.5mm, 8mm

STANLEY

Part No.	Price
902 0555	£33.47

61 PIECE SCREWDRIVER SET



Screwdriver, Bit & Nut Driver Set
Magnetized Tips
Soft Grip Handles
Wall Mountable Display

SEALEY

Part No.	Price
SEAS01152	£52.47

Tools

HSS JOBBER DRILLS - METRIC



Premium Quality Drill for use with Alloy Steel, Cast Iron, Non Ferrous Metals & Plastic

High Grade M2 Alloyed HSS Steel to DIN 338

Part No.	Drill Ø	Length	Price (ea)
902 0560	1.0mm	34mm	£1.30
902 0561	1.5mm	40mm	£1.20
902 0562	2.0mm	49mm	£1.00
902 0563	2.4mm	57mm	£1.30
902 0564	2.5mm	57mm	£1.00
902 0565	3.0mm	61mm	£0.95
902 0566	3.1mm	65mm	£1.45
902 0567	3.2mm	65mm	£1.40
902 0568	3.3mm	65mm	£1.20
902 0569	3.5mm	70mm	£1.20
902 0570	3.6mm	70mm	£1.60
902 0571	3.8mm	75mm	£1.75
902 0572	4.0mm	75mm	£1.30
902 0573	4.1mm	75mm	£1.70
902 0574	4.2mm	75mm	£1.75
902 0575	4.5mm	80mm	£1.60
902 0576	4.8mm	86mm	£2.05
902 0577	4.9mm	86mm	£2.05
902 0578	5.0mm	86mm	£1.45
902 0579	5.1mm	86mm	£2.35
902 0580	5.2mm	86mm	£2.55
902 0581	5.3mm	86mm	£2.40
902 0582	5.5mm	93mm	£1.90
902 0583	6.0mm	93mm	£1.80
902 0584	6.4mm	101mm	£2.95
902 0585	6.5mm	101mm	£2.30
902 0586	6.8mm	109mm	£2.95
902 0587	7.0mm	109mm	£2.50
902 0588	7.5mm	109mm	£2.70
902 0589	8.0mm	117mm	£2.95
902 0590	8.5mm	117mm	£3.50
902 0591	9.0mm	125mm	£5.75
902 0592	9.5mm	125mm	£3.95
902 0593	10.0mm	133mm	£6.80
902 0594	10.2mm	133mm	£4.35
902 0595	10.5mm	133mm	£6.20
902 0596	11.0mm	142mm	£5.50
902 0597	11.5mm	142mm	£6.20
902 0598	12.0mm	151mm	£6.40
902 0599	12.5mm	151mm	£7.20
902 0600	13.0mm	151mm	£7.20

HSS COBALT JOBBER DRILLS



Cobalt Steel Roll Forged Jobber Drills for Tough Drilling Applications such as Stainless Steel & Cr-Ni

Manufactured to DIN 338

Part No.	Drill Ø	Length	Price (ea)
902 0610	1.0mm	34mm	£1.65
902 0611	1.5mm	40mm	£1.55
902 0612	2.0mm	49mm	£1.40
902 0613	2.5mm	57mm	£1.40
902 0614	3.0mm	61mm	£1.50
902 0615	3.2mm	65mm	£1.65
902 0616	3.3mm	65mm	£1.70
902 0617	3.5mm	70mm	£1.70
902 0618	4.0mm	75mm	£1.85
902 0619	4.2mm	75mm	£2.05
902 0620	4.5mm	80mm	£2.20
902 0621	4.8mm	86mm	£2.40
902 0622	5.0mm	86mm	£2.20
902 0623	5.5mm	93mm	£3.00
902 0624	6.0mm	93mm	£2.75
902 0625	6.5mm	101mm	£3.40
902 0626	6.8mm	109mm	£3.60
902 0627	7.0mm	109mm	£3.45
902 0628	7.5mm	109mm	£3.90
902 0629	8.0mm	117mm	£4.25
902 0630	8.5mm	117mm	£4.95
902 0631	9.0mm	125mm	£5.15
902 0632	9.5mm	125mm	£5.90
902 0633	10.0mm	133mm	£6.20
902 0634	10.2mm	133mm	£7.95
902 0635	10.5mm	133mm	£8.40
902 0636	11.0mm	142mm	£8.65
902 0637	11.5mm	142mm	£9.65
902 0638	12.0mm	151mm	£9.95
902 0639	12.5mm	151mm	£11.40
902 0640	13.0mm	151mm	£12.35

Long Series HSS Drills also available
Please contact us for details



Tools

HSS JOBBER DRILLS - IMPERIAL



Premium Quality Drill for use with Alloy Steel, Cast Iron, Non Ferrous Metals & Plastic

High Grade M2 Alloyed HSS Steel to DIN 338

Part No.	Drill Ø	Length	Price (ea)
902 0650	1/16"	1.7/8"	£1.47
902 0651	5/64"	2"	£1.58
902 0652	3/32"	2.1/4"	£1.40
902 0653	7/64"	2.5/8"	£1.55
902 0654	1/8"	2.3/4"	£1.43
902 0655	9/64"	2.7/8"	£1.95
902 0656	5/32"	3.1/8"	£1.70
902 0657	3/16"	3.1/2"	£2.13
902 0658	11/64"	3.1/4"	£2.11
902 0659	13/64"	3.5/8"	£2.56
902 0660	7/32"	3.3/4"	£2.24
902 0661	1/4"	4"	£1.90
902 0662	5/16"	4.1/2"	£4.28
902 0663	21/64"	4.5/8"	£5.82
902 0664	3/8"	5"	£6.23
902 0665	1/2"	6"	£14.42

HSS BLACKSMITH DRILLS



Premium Quality Titanium Nitride Coated Drill for use with Alloy Steel, Cast Iron, Non Ferrous Metals & Plastics

12.5mm Shank with 3 Flats

Part No.	Drill Ø	Length	Price (ea)
902 1310	13.5mm	160mm	£8.26
902 1311	14.0mm	160mm	£8.07
902 1312	14.5mm	160mm	£14.98
902 1313	15.0mm	160mm	£12.51
902 1314	15.5mm	160mm	£9.48
902 1315	16.0mm	160mm	£10.05
902 1316	16.5mm	160mm	£14.98
902 1317	17.0mm	160mm	£11.43
902 1318	17.5mm	160mm	£20.81
902 1319	18.0mm	160mm	£17.07
902 1320	18.5mm	160mm	£13.00
902 1321	19.0mm	160mm	£19.30
902 1322	19.5mm	160mm	£22.26
902 1323	20.0mm	160mm	£14.77
902 1324	22.0mm	160mm	£17.43
902 1325	24.0mm	160mm	NLA
902 1326	25.0mm	160mm	£22.50

HSS JOBBER DRILL SET



25 Piece HSS Roll Forged Jobber Drill Set
Black Oxide Finish

Metric Sizes:
1 -13mm in 0.5mm increments

Part No.	Price
902 1300	£23.45

HSS COBALT DRILL SET



25 Piece Cobalt Steel Roll Forged Jobber Drill Set
For Tough Drilling Applications such as Stainless & Cr-Ni

Metric Sizes:
1 -13mm in 0.5mm increments

Part No.	Price
902 1330	£79.03

DORMER BOXED SETS



DORMER HSS Jobber Drill Metal Case Sets
Right Hand, General Purpose
Supplied In High Quality Metal Cantilever Cases

DORMER

Part No.	Sizes	Price
902 1305	25 Metric Sizes 1.0mm to 13.0mm (in 0.5mm's)	£154.20
902 1306	21 Imperial Sizes 1/16" to 3/8" (in 64th's)	£77.98
902 1307	29 Imperial Sizes 1/16" to 1/2" (in 64th's)	£148.60

DORMER TOP-UP SETS



DORMER HSS Jobber Drills 'Top Up' Packs

DORMER

Part No.	Sizes	Price
902 1335	13 Metric Sizes in Dispenser 1.0mm to 6.5mm (in 0.5mm's) Plus 3.3mm & 4.2mm	£30.93
902 1336	13 Imperial Sizes 1/16" to 3/8" (in 64th's)	£27.00

Tools

HSS BROACHING CUTTERS



Titanium Aluminium Nitride Coating

High Grade HSS Steel Body

Part No.	Drill Ø	Depth	Price (ea)
902 0680	12mm	30mm	£15.18
902 0681	13mm	30mm	£16.75
902 0682	14mm	30mm	£19.28
902 0683	15mm	30mm	£19.82
902 0684	16mm	30mm	£20.82
902 0685	17mm	30mm	£21.83
902 0686	18mm	30mm	£22.87
902 0687	19mm	30mm	£23.88
902 0688	20mm	30mm	£24.38
902 0689	21mm	30mm	£24.88
902 0690	22mm	30mm	£25.92
902 0691	23mm	30mm	£27.25
902 0692	24mm	30mm	£28.47
902 0693	25mm	30mm	£29.28
902 0694	26mm	30mm	£32.83
902 0695	27mm	30mm	£33.85
902 0696	28mm	30mm	£34.57
902 0697	29mm	30mm	£35.60
902 0698	30mm	30mm	£36.62
902 0700	32mm	30mm	£38.93
902 0701	33mm	30mm	£39.95
902 0703	35mm	30mm	£42.00
902 0704	36mm	30mm	£43.22
902 0706	38mm	30mm	£45.55
902 0707	39mm	30mm	£46.77
902 0708	40mm	30mm	£47.78
902 0709	41mm	30mm	£61.09
902 0710	42mm	30mm	£41.65
902 0711	43mm	30mm	£64.46
902 0713	45mm	30mm	£139.60
902 0714	46mm	30mm	£74.10
902 0715	47mm	30mm	£52.48
902 0716	48mm	30mm	£53.25
902 0717	49mm	30mm	£61.48
902 0718	50mm	30mm	£72.23
902 0725	Pilot Drill - 30mm Depth		£7.90
902 0726	Pilot Drill - 50mm Depth		£7.60

Broaching Cutters also available in longer (50mm) cutting depth in some sizes

HSS 3 FLUTE COUNTERSUNK



For Countersinking Existing Holes in Metal, Plastic & Wood

90° flute angle
High Quality M2 HSS Steel

Part No.	Diam.	Screw Ø	Price (ea)
902 0730	6.3mm	3.0mm	£9.02
902 0731	8.3mm	4.0mm	£11.47
902 0732	10.4mm	5.0mm	£12.35
902 0733	12.4mm	6.0mm	£14.20
902 0734	16.5mm	8.0mm	£15.25
902 0735	20.5mm		£28.75
902 0736	25.0mm		£35.95

HSS CONE CUTTERS



For Drilling, Enlarging & De-burring Holes in Thin Sheet Metal up to 2mm Thickness
Using Suitable Lubricant is Recommended

Part No.	Diam.	Price (ea)
902 0740	3 - 14mm	£12.27
902 0741	5 - 20mm	£19.38
902 0742	5 - 31mm	£45.40
902 0743	16 - 31mm	£45.40

STEP DRILLS



For Drilling, Enlarging & De-burring Holes in Thin Sheet Metal up to 4mm Thickness
Using Suitable Lubricant is Recommended

Part No.	Diam.	Price (ea)
902 0745	4 - 12mm	£34.78
902 0746	4 - 20mm	£33.07
902 0747	4 - 30mm	£49.35
902 0748	4 - 39mm	£80.03

DE-BURRING COUNTERSINK



For Countersinking & De-Burring Existing Holes in Metal & Plastic

Transverse Hole for Burr Extraction

Part No.	Diam.	Price (ea)
902 0750	2 - 5mm	£9.02
902 0751	5 - 10mm	£11.95
902 0752	10 - 15mm	£22.80
902 0753	15 - 20mm	£32.25

Tools

MASONRY BITS - SDS PLUS



Professional SDS Plus
Hammer Bits
High Quality, BC20 Tungsten
Carbide Tip
Nickel/Chromoly Shank

Part No.	Drill Ø	Length	Price (ea)
902 0761	4.0mm	160mm	£1.60
902 0763	5.0mm	110mm	£2.24
902 0764	5.0mm	160mm	£2.65
902 0765	5.0mm	210mm	£2.70
902 0766	5.5mm	110mm	£1.80
902 0767	5.5mm	160mm	£2.65
902 0768	5.5mm	210mm	£3.63
902 0769	6.0mm	110mm	£2.29
902 0770	6.0mm	160mm	£2.60
902 0771	6.0mm	210mm	£3.27
902 0772	6.0mm	260mm	£4.95
902 0773	6.0mm	360mm	£9.82
902 0774	6.5mm	110mm	£1.90
902 0775	6.5mm	160mm	£2.05
902 0776	6.5mm	210mm	£2.90
902 0777	6.5mm	260mm	£3.80
902 0778	7.0mm	110mm	£2.05
902 0779	7.0mm	160mm	£2.72
902 0780	7.0mm	210mm	£3.15
902 0781	7.0mm	260mm	£5.08
902 0782	8.0mm	110mm	£2.73
902 0783	8.0mm	160mm	£2.90
902 0784	8.0mm	210mm	£3.32
902 0785	8.0mm	260mm	£4.25
902 0787	8.0mm	310mm	£6.90
902 0788	8.0mm	450mm	£6.75
902 0790	9.0mm	210mm	£4.60
902 0791	10.0mm	160mm	£2.85
902 0792	10.0mm	210mm	£3.82
902 0793	10.0mm	260mm	£4.50
902 0794	10.0mm	310mm	£5.07
902 0795	10.0mm	350mm	£10.75

902 0796	10.0mm	450mm	£6.95
902 0797	10.0mm	600mm	£10.75
902 0802	12.0mm	210mm	£4.68
902 0803	12.0mm	260mm	£5.47
902 0804	12.0mm	310mm	£6.07
902 0805	12.0mm	450mm	£7.10
902 0806	12.0mm	600mm	£11.05
902 0807	12.0mm	1000mm	£32.43
902 0811	14.0mm	160mm	£4.85
902 0812	14.0mm	210mm	£5.68
902 0813	14.0mm	260mm	£5.55
902 0814	14.0mm	310mm	£7.77
902 0815	14.0mm	450mm	£11.43
902 0816	14.0mm	1000mm	£36.88
902 0817	15.0mm	250mm	£7.77
902 0818	16.0mm	160mm	£6.15
902 0819	16.0mm	210mm	£7.00
902 0820	16.0mm	250mm	£8.75
902 0821	16.0mm	300mm	£9.60
902 0822	16.0mm	450mm	£12.37
902 0823	16.0mm	600mm	£14.40
902 0825	18.0mm	260mm	£8.00
902 0826	18.0mm	300mm	£11.82
902 0827	18.0mm	450mm	£16.62
902 0830	20.0mm	200mm	£12.70
902 0831	20.0mm	300mm	£15.30
902 0832	20.0mm	450mm	£19.23
902 0833	20.0mm	600mm	£25.22
902 0834	20.0mm	1000mm	£36.95
902 0835	22.0mm	250mm	£17.27
902 0836	22.0mm	450mm	£20.02
902 0839	24.0mm	450mm	£22.28
902 0840	25.0mm	250mm	£19.23
902 0841	25.0mm	450mm	£22.95
902 0842	25.0mm	600mm	£35.80
902 0843	25.0mm	1000mm	£53.60
902 0845	28.0mm	450mm	£44.62
902 0846	30.0mm	450mm	£51.48

Tools

MASONRY BITS - SDS MAX



Professional SDS Max Hammer Bits For Drilling Large Diameter Holes in Concrete, Stone & Masonry

MASONRY BITS - STRAIGHT



Premium Quality Masonry Drill Straight Shank for use with Impact/Percussion Drills Tungsten Carbide Tip Heat Treated

Part No.	Drill Ø	Length	Price (ea)
902 0850	12.0mm	340mm	£20.00
902 0862	12.0mm	540mm	£25.83
902 0851	14.0mm	340mm	£20.93
902 0863	14.0mm	540mm	£26.15
902 0852	16.0mm	340mm	£22.20
902 0864	16.0mm	540mm	£28.77
902 0853	18.0mm	340mm	£25.88
902 0865	18.0mm	540mm	£31.37
902 0874	18.0mm	690mm	£34.67
902 0878	18.0mm	920mm	£47.83
902 0854	20.0mm	340mm	£28.77
902 0866	20.0mm	540mm	£33.77
902 0875	20.0mm	690mm	£37.27
902 0879	20.0mm	920mm	£50.12
902 0855	22.0mm	340mm	£32.43
902 0867	22.0mm	540mm	£43.05
902 0876	22.0mm	690mm	£44.48
902 0880	22.0mm	920mm	£60.60
902 0856	24.0mm	340mm	£34.38
902 0868	24.0mm	540mm	£51.03
902 0857	25.0mm	340mm	£35.37
902 0869	25.0mm	540mm	£52.33
902 0877	25.0mm	690mm	£58.22
902 0881	25.0mm	920mm	£70.12
902 0858	26.0mm	340mm	£38.00
902 0870	26.0mm	540mm	£57.58
902 0859	28.0mm	340mm	£39.25
902 0871	28.0mm	540mm	£60.83
902 0860	30.0mm	340mm	£45.52
902 0872	30.0mm	540mm	£49.00
902 0861	32.0mm	340mm	£49.73
902 0873	32.0mm	540mm	£79.85

Part No.	Drill Ø	Length	Price (ea)
902 0900	3.0mm	60mm	£2.05
902 0901	4.0mm	75mm	£0.95
902 0902	4.0mm	150mm	£1.40
902 0903	5.0mm	85mm	£1.77
902 0904	5.0mm	150mm	£1.60
902 0905	5.5mm	85mm	£1.15
902 0906	5.5mm	150mm	£1.55
902 0907	6.0mm	100mm	£1.40
902 0908	6.0mm	150mm	£1.45
902 0909	6.0mm	200mm	£2.25
902 0910	6.0mm	300mm	£4.05
902 0911	6.5mm	100mm	£1.55
902 0912	6.5mm	150mm	£1.65
902 0913	6.5mm	200mm	£2.50
902 0914	6.5mm	300mm	£4.20
902 0915	7.0mm	100mm	£1.60
902 0916	7.0mm	150mm	£1.75
902 0917	7.0mm	300mm	£4.45
902 0918	8.0mm	120mm	£1.70
902 0919	8.0mm	150mm	£1.90
902 0920	8.0mm	200mm	£2.95
902 0921	8.0mm	300mm	£4.95
902 0922	10.0mm	120mm	£2.20
902 0923	10.0mm	150mm	£2.50
902 0924	10.0mm	200mm	£3.70
902 0925	10.0mm	300mm	£5.15
902 0926	10.0mm	400mm	£7.25
902 0927	12.0mm	150mm	£2.95
902 0928	12.0mm	200mm	£4.10
902 0929	12.0mm	300mm	£6.40
902 0930	12.0mm	400mm	£8.05
902 0931	14.0mm	150mm	£3.95
902 0932	14.0mm	200mm	£5.10
902 0933	14.0mm	400mm	£8.70
902 0934	16.0mm	150mm	£4.65
902 0935	16.0mm	200mm	£6.30
902 0936	16.0mm	300mm	£7.60
902 0937	16.0mm	400mm	£10.35
902 0938	20.0mm	200mm	£8.35
902 0939	20.0mm	400mm	£13.95
902 0941	25.0mm	400mm	£16.90

SDS PLUS - SDS MAX ADAPTOR



SDS Plus to SDS Max Adaptor

Part No.	Price
902 0890	£51.20

Tools

DIAMOND TILE & GLASS BITS



Professional Wet Cut Diamond Bit for Glass, Ceramic, Marble & Slate

Electroplated Diamond Particles

Part No.	Drill Ø	Length	Price (ea)
902 0952	7.0mm	65mm	£17.09
902 0954	10.0mm	65mm	£10.50
902 0955	12.0mm	65mm	£12.30
902 0957	20.0mm	65mm	£19.75

TCT TILE & GLASS BITS



For Accurate Drilling of Glass & Ceramics

Tungsten Carbide Tip

Part No.	Drill Ø	Length	Price (ea)
902 0965	5.0mm	60mm	£2.68
902 0966	6.0mm	60mm	£3.02
902 0967	6.5mm	75mm	£3.20
902 0968	7.0mm	75mm	£3.37
902 0969	8.0mm	75mm	£3.60
902 0970	10.0mm	80mm	£4.67

CHUCK KEYS



Drill Chuck Keys

Part No.	Size or Application	Price
902 0975	S2/K2	£2.36
330034-07	S3	POA
902 0977	S7/K1	POA
902 0978	S8/K30	POA
902 0979	S9/K32	POA
902 0980	S10/K3	POA
902 0981	S13/K4	POA
902 0982	S14/K9	POA
763430-3	Makita	£4.83

Chuck & Key Capacity: 1.5 - 10mm		Keyless Chuck Capacity: 2.0 - 13mm	
902 0990	£9.90	902 0991	£19.12
Heavy Duty Keyless Chuck Capacity: 2.0 - 13mm		Single Handed Keyless Chuck. Capacity: 2.0 - 13mm	
902 0992	£37.87	902 0993	£16.17
SDS Plus 1/2" Chuck Set Capacity: 1.5 - 13mm		SDS Plus Keyless Chuck Set Capacity: 1.5 - 13mm	
902 0994	£10.50	902 0995	£18.98

SDS PLUS CHUCK ADAPTOR



SDS Plus Standard
Chuck Adaptor

Part No.	Price
902 0996	£3.57

Specialist cutting attachments available to order
Please contact us with your requirements

Tools

Hand & Machine Taps

Our hand and machine taps are supplied as either taper, second or plug cut and also as a set of 3. In addition to the sizes listed below we offer a complete range of metric standard sizes (M) through to M68 x 6.0, metric fine (MF) and extra fine (MFF) sizes to M90 x 2.0. A full range of imperial taps are also available - UNC, UN, UNF, UNEF, BSW, BSPT etc.

Please contact us with your requirements.



Metric Taps - Standard

Straight Flute Metric
Hand Taps
ISO-thread to DIN 13



Size	Taper		2nd Cut		Plug Cut		Set	
	Part No.	Price (ea)	Part No.	Price (ea)	Part No.	Price (ea)	Part No.	Price
M2 x 0.40	902 1400A	£7.00	902 1400B	£7.00	902 1400C	£7.00	902 1400S	£21.41
M3 x 0.50	902 1401A	£3.75	902 1401B	£3.75	902 1401C	£3.75	902 1401S	£11.73
M4 x 0.70	902 1402A	£3.45	902 1402B	£3.45	902 1402C	£3.45	902 1402S	£10.65
M5 x 0.80	902 1403A	£3.70	902 1403B	£3.70	902 1403C	£3.70	902 1403S	£11.28
M6 x 1.00	902 1404A	£3.70	902 1404B	£3.70	902 1404C	£3.70	902 1404S	£10.88
M8 x 1.25	902 1405A	£4.25	902 1405B	£4.25	902 1405C	£4.25	902 1405S	£13.25
M10 x 1.50	902 1406A	£5.67	902 1406B	£5.51	902 1406C	£5.67	902 1406S	£17.00
M12 x 1.75	902 1407A	£8.02	902 1407B	£8.02	902 1407C	£8.02	902 1407S	£24.04

Metric Taps - Fine

Straight Flute
Metric Fine
Hand Taps
ISO-thread to DIN 13

Size	Taper		2nd Cut		Plug Cut		Set	
	Part No.	Price (ea)	Part No.	Price (ea)	Part No.	Price (ea)	Part No.	Price
M5 x 0.50	902 1410A	£8.10	902 1410B	£8.10	902 1410C	£9.80	902 1410S	£27.21
M6 x 0.75	902 1411A	£6.75	902 1411B	£6.45	902 1411C	£6.45	902 1411S	£20.23
M8 x 1.00	902 1412A	£7.79	902 1412B	£7.45	902 1412C	£7.45	902 1412S	£23.40
M10 x 1.25	902 1413A	£9.98	902 1413B	£9.98	902 1413C	£9.50	902 1413S	£29.91
M12 x 1.50	902 1414A	£12.99	902 1414B	£12.40	902 1414C	£12.40	902 1414S	£38.96

Imperial Taps - UNC

Straight Flute Imperial
Hand Taps
Unified Coarse thread
ANSI B 1.1



Size	Taper		2nd Cut		Plug Cut		Set	
	Part No.	Price (ea)	Part No.	Price (ea)	Part No.	Price (ea)	Part No.	Price
1/4 x 20	902 1420A	£4.10	902 1420B	£4.10	902 1420C	£4.10	902 1420S	£12.79
5/16 x 18	902 1421A	£4.60	902 1421B	£4.60	902 1421C	£5.56	902 1421S	£13.89
3/8 x 16	902 1422A	£5.85	902 1422B	£5.85	902 1422C	£5.85	902 1422S	£18.29
7/16 x 14	902 1423A	£9.90	902 1423B	£11.99	902 1423C	£11.99	902 1423S	£29.10
1/2 x 13	902 1424A	£8.25	902 1424B	£8.66	902 1424C	£8.25	902 1424S	£25.99
5/8 x 11	902 1425A	£12.99	902 1425B	£15.00	902 1425C	£12.40	902 1425S	£36.40
3/4 x 10	902 1426A	£18.15	902 1426B	£18.15	902 1426C	£18.15	902 1426S	£54.48
1 x 8	902 1427A	£35.70	902 1427B	£43.18	902 1427C	£43.18	902 1427S	£125.06

Imperial Taps - UNF

Straight Flute Imperial
Hand Taps
Unified Fine thread
ANSI B 1.1



Size	Taper		2nd Cut		Plug Cut		Set	
	Part No.	Price (ea)	Part No.	Price (ea)	Part No.	Price (ea)	Part No.	Price
1/4 x 28	902 1460A	£4.70	902 1460B	£4.70	902 1460C	£4.70	902 1460S	£14.68
5/16 x 24	902 1461A	£5.88	902 1461B	£6.23	902 1461C	£6.23	902 1461S	£16.54
3/8 x 24	902 1462A	£6.55	902 1462B	£6.55	902 1462C	£6.55	902 1462S	£20.05
7/16 x 20	902 1463A	£9.89	902 1463B	£9.45	902 1463C	£9.89	902 1463S	£28.84
1/2 x 20	902 1464A	£9.89	902 1464B	£9.45	902 1464C	£9.45	902 1464S	£27.60
5/8 x 18	902 1465A	£16.02	902 1465B	£15.25	902 1465C	£15.25	902 1465S	£44.55
3/4 x 16	902 1466A	£25.04	902 1466B	£20.70	902 1466C	£25.04	902 1466S	£62.84
1 x 12	902 1467A	£51.46	902 1467B	£51.46	902 1467C	£42.55	902 1467S	£148.10

Tools

Imperial Taps - BSW

Straight Flute Hand Taps
Whitworth thread BS 84



Size	Taper		2nd Cut		Plug Cut		Set	
	Part No.	Price (ea)	Part No.	Price (ea)	Part No.	Price (ea)	Part No.	Price
1/4 x 20	902 1430A	£5.56	902 1430B	£5.56	902 1430C	£4.60	902 1430S	£13.40
5/16 x 18	902 1431A	£5.25	902 1431B	£5.25	902 1431C	£5.25	902 1431S	£15.35
3/8 x 16	902 1432A	£8.17	902 1432B	£8.17	902 1432C	£8.17	902 1432S	£20.00
7/16 x 14	902 1433A	£13.60	902 1433B	£13.60	902 1433C	£13.60	902 1433S	£38.52
1/2 x 12	902 1434A	£9.50	902 1434B	£11.49	902 1434C	£11.49	902 1434S	£33.50
5/8 x 11	902 1435A	£17.05	902 1435B	£17.05	902 1435C	£14.10	902 1435S	£49.10
3/4 x 10	902 1436A	£25.52	902 1436B	£25.52	902 1436C	£21.10	902 1436S	£73.42
1 x 8	902 1437A	£49.47	902 1437B	£49.47	902 1437C	£49.47	902 1437S	£145.69

Imperial Taps - BSF

Straight Flute Hand Taps
British Standard Fine Thread
BS 84



Size	Taper		2nd Cut		Plug Cut		Set	
	Part No.	Price (ea)	Part No.	Price (ea)	Part No.	Price (ea)	Part No.	Price
1/4 x 26	902 1440A	£7.07	902 1440B	£7.07	902 1440C	£5.85	902 1440S	£17.20
5/16 x 22	902 1441A	£8.58	902 1441B	£8.58	902 1441C	£7.10	902 1441S	£20.90
3/8 x 20	902 1442A	£8.45	902 1442B	£8.45	902 1442C	£8.45	902 1442S	£29.39
1/2 x 16	902 1443A	£12.80	902 1443B	£12.80	902 1443C	£15.48	902 1443S	£37.85
5/8 x 14	902 1444A	£21.55	902 1444B	£20.55	902 1444C	£21.55	902 1444S	£61.59
3/4 x 12	902 1445A	£35.91	902 1445B	£35.91	902 1445C	£35.91	902 1445S	£104.73
1 x 10	902 1446A	£61.20	902 1446B	£61.20	902 1446C	£61.20	902 1446S	£172.10

Imperial Taps - BSPT

Straight Flute Hand Taps
Tapered Pipe Thread Iso 529
Available In 1:16 Taper Only



Part No.	Size	Price (ea)
902 1450	1/8 x 28	£14.66
902 1451	1/4 x 19	£16.24
902 1452	3/8 x 19	£27.95
902 1453	1/2 x 14	£30.70
902 1454	5/8 x 14	£38.05
902 1455	3/4 x 14	£42.38
902 1456	7/8 x 14	£55.69
902 1457	1 x 11	£60.22

Left Hand Taps

We offer a full range of left hand threaded taps in all leads, taper, 2nd and plug cut.

Long Series Taps

We offer a full range of metric and metric fine long series taps.

Machine Taps

Spiral point and spiral flute machine taps available to order - please contact us for details.

TAP & DRILL SET - M3-M12



Covers the Range M3, 4, 5, 6, 8, 10, 12
3 Taps Per Size (Hss)
7 Tapping Drills Included
1 X Adjustable Tap Wrench
1 X Ratchet Tap Wrench to suit
Supplied in Metal Index Box



Part No.	Price
902 1480	£124.40

TAP & DRILL BOX SET



Second Tap and Drill Box Set
Supplied in a Robust Plastic
Twin Box Case.

Available in Tap Sizes:
M4-M5-M6-M8-M10-M12-M14



Part No.	Size	Price
902 1482	4mm	£3.60
902 1483	5mm	£4.00
902 1484	6mm	£4.20
902 1485	8mm	£5.20
902 1486	10mm	£6.80
902 1487	12mm	£11.00
902 1488	14mm	£12.00



A full range of Metric and Imperial
Tap & Die Sets are available to order.
Please contact us with your requirements.

Tools

ADJUSTABLE TAP WRENCHES

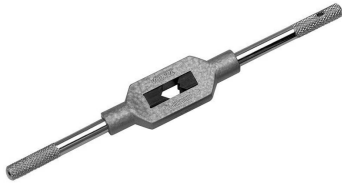

DIN 1814
Zinc Die Cast

(Also Available in Steel)



Part No.	No.	For DIN Taps	Price
902 1490		M1 - 8 (1/16-1/4")	£7.80
902 1491	1	M1 - 10 (1/16-3/8")	£8.27
902 1492	1.1/2	M1 - 12 (1/16-1/2")	£8.60
902 1493	2	M4 - 12 (5/32-1/2")	£12.20
902 1494	3	M5 - 20 (7/32-3/4)	£20.15
902 1495	4	M11 - 27 (7/16-1")	£34.72

Dies & Die Nuts

A full range of circular, solid and split dies are available in metric, metric fine, UNC, UNF, BSW, BSF and BA. In addition we also offer die nuts to compliment this range.

Please contact us with your requirements.



RATCHET TAP HANDLE



For Right & Left Hand Turn



Part No.	No.	For DIN Taps	Length	Price
902 1525	1	M3 - M10	85mm	£14.95
902 1526	2	M5 - M12	100mm	£19.45
902 1527	10	M3 - M10	250mm	£28.25
902 1528	20	M5 - M12	300mm	£30.70

DIE STOCKS



DIN 1814
Zinc Die Cast with 3 Screws

(Also Available in Steel)



Part No.	Description	Price
902 1500	13/16" x 1/4"	£5.25
902 1502	1.5/16" x 7/16"	£7.93
902 1503	1.1/2" x 1/2"	£9.55
902 1504	2" x 5/8"	£19.85
902 1505	2.1/4" x 11/16"	£20.50

HELICOIL KITS



A Simple & Cost Effective System for Repairing Damaged Threads

Kit comes complete with Helicoil Tap, Tang Removal Tool & Helicoils

Part No.	Size	Price
902 1535	3mm	£24.90
902 1536	4mm	£24.90
902 1537	5mm	£24.95
902 1538	6mm	£27.95
902 1539	8mm	£32.72
902 1540	10mm	£35.20
902 1541	12mm	£42.50
902 1542	14mm (Spark Plug Kit)	£56.10

HELICOIL INSERTS



A Simple & Cost Effective System for Repairing Damaged Threads

Self Locking Inserts also Available

Part No.	Size	Price
902 1510	3mm x 0.50	£0.45
902 1511	4mm x 0.70	£0.70
902 1512	5mm x 0.80	£0.39
902 1513	6mm x 1.00	£0.39
902 1514	8mm x 1.25	£0.45
902 1515	10mm x 1.50	£0.55
902 1516	12mm x 1.75	£0.85
902 1517	14mm x 1.25	£1.05

Helicoils & Helicoil Kits

Full range of sizes available - please contact us

Tools



Starrett Bi-Metal Holesaws

Starrett professional dual cut bi-metal hole saws are constructed of hardened heat and abrasion resisting high speed teeth with a tough alloy body and cap.

Exceptional strength, durability and shatter resistance for user safety.
Will cut any wood, metal or plastic in either a hand-held drill or a drill press.



Part No.	Hole Ø	Price (ea)			
902 1600	14.0mm	£8.72	902 1633	68.0mm	£14.95
902 1601	16.0mm	£6.92	902 1634	70.0mm	£14.97
902 1602	17.0mm	£6.92	902 1635	73.0mm	£15.30
902 1603	19.0mm	£6.92	902 1636	76.0mm	£15.60
902 1604	20.0mm	£6.92	902 1637	79.0mm	£15.90
902 1605	21.0mm	£6.92	902 1638	83.0mm	£16.50
902 1606	22.0mm	£6.92	902 1639	86.0mm	£17.07
STRHS24AX	24.0mm	£7.70	902 1640	89.0mm	£17.63
902 1608	25.0mm	£8.88	902 1641	92.0mm	£18.10
902 1609	27.0mm	£9.18	902 1642	95.0mm	£19.75
902 1610	29.0mm	£9.83	902 1643	98.0mm	£21.02
902 1611	30.0mm	£10.32	902 1644	102.0mm	£22.18
902 1612	32.0mm	£10.32	902 1645	105.0mm	£23.20
902 1613	33.0mm	£10.33	902 1646	108.0mm	£28.70
902 1614	35.0mm	£11.28	902 1647	111.0mm	£31.52
902 1615	37.0mm	£11.28	902 1648	114.0mm	£32.43
902 1616	38.0mm	£11.28	902 1649	121.0mm	£37.60
902 1617	40.0mm	£12.17	902 1650	127.0mm	£42.62
902 1618	41.0mm	£12.27	902 1651	133.0mm	£45.60
902 1619	43.0mm	£12.73	902 1652	140.0mm	£48.13
902 1620	44.0mm	£12.73	902 1653	152.0mm	£54.85
902 1621	46.0mm	£12.73	902 1655	168.0mm	£97.00
902 1622	48.0mm	£12.73	902 1656	177.0mm	£98.80
902 1623	51.0mm	£12.73	902 1657	210.0mm	£109.20
902 1624	52.0mm	£13.23			
902 1625	54.0mm	£13.65			
902 1626	56.0mm	£14.03			
902 1627	57.0mm	£14.20			
902 1628	59.0mm	£14.35			
902 1629	60.0mm	£14.52			
902 1630	64.0mm	£14.60			
902 1631	65.0mm	£14.68			
902 1632	67.0mm	£14.93			

HOLESAW ARBORS

Professional Quality Starrett Holesaw Arbors



Part No.	Description	Price
902 1665	A1 Arbor (14 - 30mm Holesaws)	£8.85
902 1666	A2 Arbor (32 - 210mm Holesaws)	£17.77
902 1667	Pilot Drill to suit A1 & A2 Arbors	£3.92

Tools

DIAMOND CORE BITS



For Drilling Clean Holes in
Brick Block & Medium Density
Concrete
10mm Deep Segment
1/2" BSP Fitting

Part No.	Drill Ø	Length	Price
902 1670	22mm	300mm	£57.10
902 1671	28mm	300mm	£58.45
902 1672	32mm	150mm	£55.77
902 1673	38mm	150mm	£56.43
902 1674	48mm	150mm	£60.47
902 1675	52mm	150mm	£61.82
902 1676	65mm	150mm	£73.90
902 1677	78mm	150mm	£82.60
902 1678	82mm	150mm	£87.70
902 1679	91mm	150mm	£94.80
902 1680	107mm	150mm	£98.70
902 1681	117mm	150mm	£100.00
902 1682	127mm	150mm	£111.00
902 1683	152mm	150mm	£132.30

DIAMOND CORE ACCESSORIES



Adaptors, Extension Pieces
& Pilots

Part No.	Description	Price
902 1690	88mm Hex Adaptor - 1/2" BSP	£8.27
902 1691	240mm Hex Adaptor - 1/2" BSP	£13.40
902 1692	115mm SDS Adaptor - 1/2" BSP	£8.27
902 1693	240mm SDS Adaptor - 1/2" BSP	£13.40
902 1694	240mm Extension - 1/2" BSP	£18.28
902 1695	13mm x 210mm Pilot Drill	£5.53
902 1696	225mm Taper Pilot Rod	£4.15
902 1697	8mm x 75mm Taper Drift	£1.88

SABRE BLADES FOR WOOD



Sabre Shank Carbon Steel
Blades
For Softwoods, Chipboard,
Plywood, Fibreboard, Plastics
(pack of 5 blades)

Part No.	Length	tpi	Bosch No.	Price
902 1710	150mm	4.3	S644D	£11.35
902 1711	240mm	0.8	S1531L	£17.40
902 1712	300mm	6	S1411DF	£30.25

JIGSAW BLADES - WOOD



Economic High Carbon Steel
For Softwoods, Chipboard,
Plywood, Fibreboard, Plastics,
Insulation Materials
(pack of 5 blades)

Part No.	Length	tpi	Bosch No.	Price
902 1713	76mm	13	T119B	£4.52
902 1714	100mm	8.5	T111C	£4.05
902 1715	100mm	10	T101B	£7.40
902 1716	100mm	3.35	T244D	£7.27

JIGSAW BLADES - WOOD



Premium High Carbon Steel
Taper Ground Teeth
For Softwoods, Chipboard,
Plywood, Fibreboard, Plastics,
Insulation Materials
(pack of 5 blades)

Part No.	Length	tpi	Bosch No.	Price
902 1720	76mm	19	T101AO	£6.78
902 1721	100mm	10	T101BRF	£13.50
902 1722	100mm	10	T101BR	£8.15
902 1723	100mm	3.35	T144D	£5.77

JIGSAW BLADES - METAL



High Speed Steel Blades
For: Metal Sheets, Aluminium,
Stainless Steel, Non-ferrous
Metal, Pipes, Profiles,
Sandwich Materials
(pack of 5 blades)

Part No.	Length	tpi	Bosch No.	Price
902 1730	76mm	13	T118B	£6.60
902 1731	132mm	14	T318B	£14.28
902 1732	100mm	8.5	T127D	£7.03
902 1733	76mm	13	T118BF	£8.57

SABRE BLADES FOR METAL



Sabre Shank Flexible Bi-Metal
For Steel, Metal Sheet,
Stainless Steel & Non Ferrous
Metals
(pack of 5 blades)

Part No.	Length	tpi	Bosch No.	Price
902 1740	150mm	14	S922BF	£14.90
902 1741	200mm	14	S1122BF	£19.88
902 1742	150mm	18	S922EF	£14.90
902 1743	200mm	18	S1122EF	£19.88
902 1744	150mm	24	S922AF	£20.47
902 1745	200mm	24	S1122AF	£27.63

Tools

BAHCO 12" HACKSAW FRAME



Professional Hacksaw Frame
High Blade Tension
Ergonomic Handle Design
Supplied with Bahco 12" Blade



Part No.	Price
902 1750	£14.98

12" HACKSAW BLADES



Professional High Alloyed HSS
Hacksaw Blades - 12"
Long Life

Part No.	tpi	Price (ea)
902 1760	18	£1.60
902 1761	24	£1.60
902 1762	32	£1.60

BAHCO MINI HACKSAW



Rigid Zinc Plated Steel Frame
Ergonomic Handle
Complete with 150mm, 32tpi
Blade



Part No.	Price
902 1751	£14.98

JUNIOR HACKSAW BLADES



Carbon Steel Junior Hacksaw
Blades - 150mm

10 Pack



Part No.	tpi	Price
902 1763	32	£3.50

BAHCO JUNIOR HACKSAW



Rigid Zinc Plated Steel Frame
Ergonomic Handle
Complete with 150mm, 32tpi
Blade



Part No.	Price
902 1752	£5.21

COPING SAW BLADES



Carbon Steel Coping Saw
Blades - 165mm

5 Pack



Part No.	tpi	Price
902 1764	14	£4.80

BAHCO COPING SAW



Ideal for Cutting Curves in
Wood, Fibre Board, Plywood,
Plastic, Laminates, Glass Fibre
Supplied with 165mm Blade



Part No.	Price
902 1753	£16.73

IRWIN JACK SAW - 20"



Irwin 880 Professional
Handsaw for Cutting All Types
of Wood
Long Life Blade



Part No.	Price
902 1765	£13.92

BAHCO DRYWALL SAW



Professional Drywall/
Plasterboard Saw 160mm
Teeth 8tpi



Part No.	Price
902 1754	£16.62

BAHCO 30" BOW SAW



Lightweight, Heavy Duty Bow
Saw
Supplied with 30" Dry Cut
Blade



Part No.	Description	Price
902 1766	30" Bowsaw	£25.86
902 1767	30" Blade	£4.08

Tools

DIE-CAST RETRACTABLE KNIFE



Heavy Duty, Die-Cast Metal Body
Ergonomical Grip

STANLEY

Part No.	Price
902 1775	£8.20

SLIM TRIMMING KNIFE



Lightweight Die-Cast Metal Body
Slim Knife
Interlock Feature

STANLEY

Part No.	Price
902 1780	£8.92

SLIDING POCKET KNIFE



All Metal Construction
Easy, Tool-less Blade Change
One Handed Operation

STANLEY

Part No.	Price
902 1776	£10.18

9MM SNAP-OFF BLADES



13 Snap-Off Sections
10 Blades

STANLEY

Part No.	Price
902 1785	£3.53

HEAVY DUTY TRIMMING KNIFE



Lightweight Aluminium Body
Strong Brass Wheel for Blade Locking

STANLEY

Part No.	Price
902 1777	£18.50

18MM SNAP-OFF BLADES

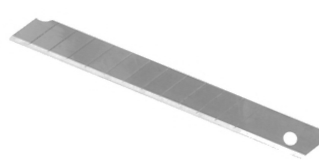

7 Snap-Off Sections
10 Blades

STANLEY

Part No.	Price
902 1786	£4.65

SNAP OFF BLADE KNIFE



Die-Cast Metal Construction
Interlock 18mm Snap-Off Blade
Knife with 7 Segments

STANLEY

Part No.	Price
902 1778	£8.92

TRIMMING BLADE



Trimming/Craft Knife Blades
3 Blades

STANLEY

Part No.	Price
902 1787	£2.53

SLIM SNAP-OFF BLADE KNIFE



Die-Cast Metal Construction
Interlock 9mm Snap-Off Blade
Knife with 13 Segments

STANLEY

Part No.	Price
902 1779	£5.70

1991B KNIFE BLADES



1991B Stanley Blades

STANLEY

Part No.	Description	Price
902 1788	10 Pack	£3.20
902 1789	100 Pack	£25.40

Tools

COMBINATION PLIERS



Combination Pliers
Chrome Vanadium Steel
Induction Hardened Jaws
Cushion Grip

Part No.	Description	Price
902 1800	160mm (6")	£9.88

SIDE CUTTERS



Diagonal Cutting Plier
Chrome Vanadium Steel
Induction Hardened Jaws

Part No.	Description	Price
902 1802	160mm (6")	£8.71
902 1803	180mm (7")	£13.13

LONG NOSE PLIERS



Long Nose Pliers
Chrome Vanadium Steel
Induction Hardened Jaws
Cushion Grip

Part No.	Description	Price
902 1805	180mm (7")	£10.48

VDE SIDE CUTTERS



VDE Rated Tools Can Safely
Be Used When Working On
Live Electrical Wires At
Voltages Of Up To 1000v AC
TUV/GS/VDE Approved

Part No.	Description	Price
902 1806	150mm (6")	£20.70
902 1807	175mm (7")	£23.18

BENT NOSE PLIER



200mm Professional Bent
Nose Plier
Chrome Vanadium Steel
Induction Hardened Jaws
Cushion Grip

Part No.	Price
902 1808	£23.90

WATERPUMP PLIERS - 250MM



A Specialist Tool for Gripping
Pipes, Nuts and Bolts with a
Quick Action Sliding Pivot to
Provide a Wide Range of
Jaw Settings

Part No.	Price
902 1809	£14.43

END CUTTERS - 200MM



Heavy-Duty End Cutting Pliers
Ideally Suited for Cutting Soft,
Medium and Medium Hard
Wire Extrusions Close to
the Surface

Part No.	Price
902 1810	£15.88

FENCING PLIERS - 250MM



These Versatile Pliers Perform
The Following Functions, Nail
Extraction, Nail Driving, Staple
Extraction, Wire Cutting, Wire
Pulling and Wire Squeezing.

Part No.	Price
902 1811	£20.42

VDE COMBINATION PLIERS



VDE Rated Tools Can Safely
Be Used When Working On
Live Electrical Wires At
Voltages Of Up To 1000v AC
To DIN ISO 5749

Part No.	Description	Price
902 1812	180mm (7")	£19.27
902 1813	200mm (8")	£22.03

Tools

PRECISION SCREWDRIVER SET



Jewellers Precision
Screwdriver Set
1045 Carbon Steel
Flat : 0.9, 1.2, 1.8, 2.4, 3.0
In Plastic Storage Box

Part No.	Price
902 1830	£4.17

BUTANE GAS SOLDERING KIT



Kit Includes:
Blow Torch Attachment
Soldering Tip
Solder
Stand

Torch Temperature 1300°C.
Solder up to 400°C.
GS Certificated.

Part No.	Price
902 1840	£35.00

VDE VOLTAGE TESTER



Fully Insulated Circuit Voltage
Testing Screwdriver
Conforms to VDE, GS &
GE Standards

Part No.	Price
902 1833	£2.35

SOLDERING GUN 240V



Voltage: 230/240V
Input Power: 100W/140W
Max. Temperature: 480°C
Cord Length: 1.5m
Weight: 1.36kg

Part No.	Price
WELG940023G	£77.45

SEALEY DIGITAL TACHOMETER



Professional quality laser
instrument for fast and
accurate measurement of
rotational speed with or
without contact.



Part No.	Price
SEATA050	£119.80

40 WATT SOLDERING IRON



40W 240v Light Duty
Soldering Iron
3.5mm Dia. Tip
Spare Tips Available

Part No.	Price
902 1845	£10.78

DIGITAL MULTIMETER



DC Volts: 0 - 500v
AC Volts: 200 - 500v
DC Amps: 2mA - 10A
Resistance: 200Ω - 20MΩ
Temperature: 40 - 1000°C

Part No.	Price
902 1837	£23.50

40 WATT SOLDERING IRON



40W 240v Soldering Iron
6mm Dia. Tip
3 Heat Resistant LEDs
Spare Tips Available



Part No.	Price
902 1846	NLA

Tools



Record Bolt Croppers - Arm Adjusted

Arm adjusted high tensile bolt croppers with heat treated jaws for cutting very hard materials.

Centre cut, shot nose jaws for cutting pre-stressed reinforcing bar, mesh & wire, high tensile steel rods, bolts & case hardened chain, cold drawn alloy steel and tempered sprung wire.

Part No.	Model	Size	Price
902 1850	914H	14"	£159.00
902 1851	918H	18"	£188.10
902 1852	924H	24"	£223.90
902 1853	930H	30"	£269.70
902 1854	936H	36"	£352.00
902 1855	942H	42"	£466.00

CAM ADJUSTED CROPPERS



High Tensile Centre Cut Bolt Cutters
The Lighter, Cam Adjusted Design is Ideal for Difficult Working Situations

Part No.	Model	Size	Price
902 1860	BC914H	14"	NLA
902 1861	BC918H	18"	£147.30
902 1862	BC924H	24"	£195.10

REPLACEMENT JAWS



Replacement Centre Cut Jaws for Record Bolt Croppers

Nut & Bolt available separately to order

Part No.	Fits Models:	Price
902 1865	14"	£51.96
902 1866	18"	£72.47
902 1867	24"	£89.90
902 1868	30"	£120.20
902 1869	36"	£124.60
902 1870	42"	£209.80

Other bolt cropper models and spare parts available to order

Please contact us with your requirements.

BOLT CROPPERS



Powerful, Centre Cut Bolt Croppers Built to Withstand Heavy Use on Ferrous & Non Ferrous Metals

Adjustable Jaws

Part No.	Size	Price
902 1880	14"	£51.85
902 1881	18"	£90.40
902 1882	24"	£112.70
902 1883	30"	£144.10
902 1884	36"	£170.00
902 1885	42"	£218.90

WIRE ROPE CUTTER



Cuts Mild & Bowden Cable, Spring Steel Wire, Braided Wire, Fencing Wire, Wire Rope, Round Steel, Steel Rods etc. up to 6mm Diam.

Part No.	Price
902 1890	£28.50

PLASTIC TRIM SHEARS



Designed For Cutting Plastic Sections, Rubber Glazing Joints, Decorative Mouldings, Tile Trim & PVC Tape. Cuts from 0 - 90°

Part No.	Price
902 1891	£45.58

Tools

Heavy Duty Bench Vices

Compact heavy duty all steel bench mounting vices.
An integral anvil permits hammering. 5 Year manufacturers warranty against breakage

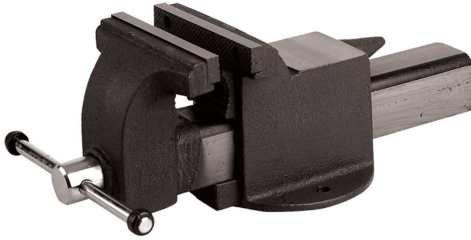

Part No.	Size	Price
902 1900	4" Heavy Duty	£136.70
902 1901	6" Heavy Duty	£201.60
902 1902	8" Heavy Duty	£244.90
902 1903	Swivel Base for 4" Vice	£24.95
902 1904	Swivel Base for 6" Vice	£34.95
902 1905	Swivel Base for 8" Vice	£34.45

LOCKING PLIERS



Locking Pliers with Curved,
Serrated Jaws
Spring Action
Hardened & Tempered Jaws
Size: 230mm, Capacity: 41mm

Part No.	Price
902 1910	£9.52

G-CLAMPS



Forged Body With Smooth
Acting Threaded Clamp
Fitted With Swivel Tip To
Reduce Marking

Part No.	Width	Depth	Price
902 1913	75mm	50mm	£7.31
902 1914	100mm	60mm	£10.12
902 1915	150mm	70mm	£14.37
902 1916	200mm	85mm	£19.24

SELF GRIP C-CLAMP



280mm Self Grip C-Clamp
Nickle Plated with Quick
Release Lever

Part No.	Price
902 1911	£12.25

SASH CLAMPS

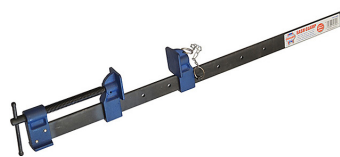

For Clamping Large Items
During Fabrication Work
Steel Bar, Malleable Iron
Head
Quick Release Action

Part No.	Size	Price
902 1920	24"	£40.53
902 1921	36"	£47.02
902 1922	48"	£53.60

WELDING CLAMP



280mm Self Grip Welding
Clamp
Nickle Plated with Quick
Release Lever

Part No.	Price
902 1912	£13.85

3 PIECE PLIER SET



3 Piece Chrome Vanadium
Soft Grip Plier Set

Set Includes:
7" Combination Pliers
6" Diagonal Cutters
10" Waterpump Pliers

Part No.	Price
FAIPLSET3N	£27.28

GILBOW STRAIGHT TINSNIPS



Gilbow Tinsnips

General Purpose One Piece
Drop Forged with Hardened
& Tempered Blades

Part No.	Size	Price
902 1925	8"	£22.50
902 1926	10"	£27.28
902 1927	12"	£30.48

Tools

STANLEY TAPE MEASURES



Long Life Nylon Coated Blade
Belt Clip & Soft Grip Case

STANLEY

Part No.	Size	Blade Width	Price
902 1940	3m	12.7mm	£4.33
902 1941	5m	19mm	£7.17
902 1942	8m	25mm	£13.68
902 1943	10m (FatMax)	32mm	£38.47

SEALEY PRO TAPE MEASURES



Professional Quality Tape Measure
Fitted with double magnets, lanyard and belt clip.

SEALEY

Part No.	Size	Blade Width	Price
SEASMT5P	5m	25mm	NLA
SEASMT8P	8m	25mm	NLA

DISTANCE MEASURING WHEEL



Durable, lightweight construction
Illuminated readout
Telescopic handle

Part No.	Price
080 001	£66.65

30M MEASURING TAPE



30m/100ft Open Reel Low Stretch Fibreglass Tape
High Impact ABS Case
Tape Width: 12mm

Part No.	Price
902 1945	£23.98

STAINLESS STEEL RULES



High Quality Stainless Steel Rule, Permanently Etched & Polished to Give Long Lasting Clarity & Accuracy of Measurement

Part No.	Size	Price
902 1965	6" (150mm)	£1.95
902 1966	12" (300mm)	£3.47
902 1967	24" (600mm)	£5.88
902 1968	39" (1000mm)	£13.37

COMBINATION SQUARES

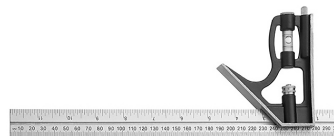

Can be used as a Try & Mitre Square, Depth Gauge, Steel Rule & Straight Edge
Spirit Level Gives Horizontal Plumb on 45° Readings

Part No.	Description	Price
902 1975	12" Square	£9.23
902 1976	12" c/w Centre Head	£21.23
902 1977	12" c/w Centre & Protractor	£20.82

ENGINEERS SQUARES



Manufactured from High Quality Tool Steel

Accurate to BS939 Grade B Standard

Part No.	Size	Price
902 1950	2"	£9.81
902 1951	3"	£10.37
902 1952	4"	£13.27
902 1953	6"	£16.25
902 1954	9"	£37.91

6" DIGITAL VERNIER



Digital Vernier Caliper
LCD Display
Hardened Stainless Steel
Plastic Storage Case

Grads: 0.01mm (0.0005")

Part No.	Price
902 1970	£19.90

ENGINEERS SQUARE SET



Manufactured from High Quality Tool Steel
Accurate to BS939 Grade B Standard Set Contains: 2", 3" 4" & 6"

Part No.	Price
902 1958	£44.57

Tools

STABILA SPIRIT LEVELS

Light Alloy Box Section
Electrostatic Power Coating
Double Plumb



Part No.	Size	Price
902 1980	60cm	£21.42
902 1981	80cm	£23.53
902 1982	100cm	£28.83
902 1983	120cm	£32.58
902 1984	180cm	£62.90

GASKET SCRAPER

For Cleaning Cylinder Heads,
Removing Old Sealants,
Carbon, Etc.



Part No.	Price
902 2001	£9.93

4 PIECE MINI HOOK SET

Designed to Ease the
Removal of O-Rings, Cotter
Pins, Seals & Bushes in
Various Automotive &
Engineering Applications



Part No.	Price
902 2002	£4.67

FEELER GAUGES

Metric & Imperial Feeler
Gauge Sets

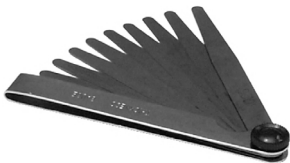

Part No.	Sizes	Price
902 1987	0.051mm to 0.635mm	£4.05

SCREW PITCH GAUGE

Combination Of 55 Metric
Standard 60 Degrees &
American National 60
Degrees Leaves per Gauge
(0.25 - 6.0mm tpi)

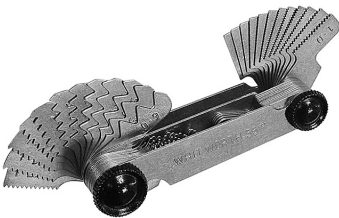

Part No.	Price
902 1990	£11.01

CYLINDER HONES

For Honing Small Bore
Cylinders

Flexible Drive Shaft Allows Easy
Alignment Whilst Working
Adjustable Honing Pressure
Suitable for use with an Electric
or Air Drill



Max Working Speed 2400r/min

Part No.	Description	Price
902 2005	25-57mm Small Cylinder Hone	£11.65
902 2009	220 Grit Stone Set	£8.27
902 2006	51-177mm Large Cylinder Hone	£33.95
902 2007	120 Grit Stone Set	£16.27
902 2008	180 Grit Stone Set	£16.27
902 2010	280 Grit Stone Set	£16.27

3 PIECE NUT SPLITTER SET

For Safe Removal of
Corroded or Damaged Nuts
Without Damaging Bolt
Threads

Capacities: 9 - 12mm,
12 - 16mm & 16 - 22mm



Part No.	Price
902 2000	£26.90

SCREW EXTRACTOR SET

Extracts Broken Screws &
Studs Leaving the Thread
Undamaged
No.s 1 to 6 (sizes 1/8 To 3/4)



Part No.	Price
902 2015	£44.52

Tools

PISTON RING COMPRESSORS



Piston Ring Compressor
Spring Steel with Steel
Adjusting Key
Thumb Operated Ratchet
Action

Part No.	Ring Sizes	Height	Price
902 2018	50 - 175mm	75mm	£18.69
902 2019	60 - 175mm	150mm	£26.22

3 LEG PULLERS



Internal/External Pullers

Chrome Vanadium Steel Legs
Swivel Thrust Plate

Part No.	Size	Price
902 2035	4"	£39.17
902 2036	6"	£51.28

PISTON RING PLIERS



Helps Prevent Scratching
Pistons and Greatly
Reduces the Risk of
Breakage

Ring Size: 50-100mm (2-4")

Part No.	Price
902 2023	£16.25

NAILSET & CENTRE PUNCH SET



Hardened & Tempered
Carbon Steel

3mm Dia. Nailset
Centre Punch

Part No.	Price
902 2040	£4.33

WIRE BRUSHES



Wooden Handled Wire
Brushes

Part No.	Bristles	Price
902 2025	2 Row	£1.96
902 2026	4 Row	£1.45

CHISEL & PUNCH SET



5 Piece Chisel & Punch Set:

Flat Cold Chisel
2 Parallel Pin Punches
Taper Pin Punch
Centre Punch

Part No.	Price
902 2042	£44.72

ENGINE CLEANING BRUSH



Plastic Handle with Bristle
Head
Length: 260mm

Part No.	Price
902 2028	£4.15

PARALLEL PIN PUNCH SET



6 Piece Round Head
Parallel Pin Punch Set
Chrome vanadium steel

Sizes:
1.5, 3, 4, 5, 6 & 8mm

Part No.	Price
902 2045	£23.80

ASSORTED BRUSH SET



Assorted Abrasive Brush
Set with Nylon, Brass &
Wire Bristles

Part No.	Price
902 2029	£3.71

AUTOMATIC CENTRE PUNCH



Single Handed Operation
Alleviates the Need for a
Hammer
Length: 125mm

Part No.	Price
902 2048	£16.60

Tools

ENGINEERS FILES



Engineers Files
Flat, Round, Half Round &
3-Square
2nd Cut & Bastard Cut

Handles Supplied Separately

ASSORTED FILES - SET OF 5



Assorted Pack of Round, Flat,
3-Square, Half Round
Engineers Files

Part No.	Size	Type	Cut	Price
902 2055	6"	Flat	2nd Cut	£3.30
902 2056	8"	Flat	2nd Cut	£2.90
902 2057	6"	Round	2nd Cut	£2.30
902 2058	8"	Flat	Bastard	£3.40
902 2059	8"	Round	2nd Cut	£2.90
902 2060	8"	Round	Bastard	£3.10
902 2061	8"	Half Round	2nd Cut	£3.90
902 2062	10"	Flat	2nd Cut	£3.40
902 2063	10"	Flat	Bastard	£3.40
902 2064	10"	Round	2nd Cut	£3.50
902 2065	10"	Round	Bastard	£3.10
902 2066	10"	Half Round	Bastard	£4.68
902 2067	12"	Flat	2nd Cut	£4.10
902 2068	12"	Round	2nd Cut	£4.13
902 2069	6"	Triangle	2nd Cut	£5.57

Part No.	Cut	Price
902 2077	2nd Cut	£14.73
902 2078	Bastard	£18.70

NEEDLE FILE SET - 6 PIECE



Set Contains Six 100mm Long
Files Fitted with Comfortable
Soft-Grip Handles

Half Round, Round, Flat Taper,
Square, Flat, Three Square

Part No.	Price
902 2079	£11.00

ASSORTED FILE HANDLES



Python Wooden Safety File
Handles - Set of 8 Handles
(2 of each size)

Sizes: 0, 1, 2, 3

Part No.	Price
902 2080	£14.88

ROUND FILES - SET OF 10



Assorted Pack of Round
Second Cut Files

Sizes: 6", 8", 10", 12"

Part No.	Price
902 2075	£26.86

FLAT FILES - SET OF 4



Assorted Pack of Flat
Engineers Files

Sizes: 6", 8", 10", 12"

Part No.	Price
902 2076	£12.38

AVIATION SNIPS



Features:
Precision-Formed Blades
Optimised Torsion Spring
Safety Latch
Lower Serrated Blade
Hi-Strength Alloy Steel Spines
Compound Cutting Action
Solid Over-Moulded Soft-Grips

Part No.	Description	Price
STA214562	Left Cut	£18.50
902 2091	Right Cut	£18.50
902 2092	Straight Cut	£18.50
902 2093	Straight/Long Cut	£24.38

Tools

3/4" COLD CHISEL



3/4" Cold Chisel
Hardened Cutting Edge

Part No.	Price
902 2100	£3.73

PRY BARS



Made From Forged
Alloy Steel
Powder Coated

Part No.	Size	Price
902 2110	6"	£5.88
902 2111	12"	£8.38
902 2112	16"	£14.82

5MM PLUGGING CHISEL



5mm Fluted Plugging Chisel
Ideal for Removing Mortar in
Brickwork Prior to Repointing

Part No.	Price
902 2101	£6.10

15" WRECKING BAR



Ideal for breaking, scrapping
& lifting.

Wide ground contact surfaces
& thin ends make it ideal for
use in narrow spaces and
reduces risk of leaving marks

Part No.	Price
902 2115	£7.42

2.1/4" FLOORING CHISEL



2.1/4" Flooring Chisel
Ideal for Cutting The Tongue
In Laid Tongued & Grooved
Floorboards

Part No.	Price
902 2102	£5.79

WRECKING BARS

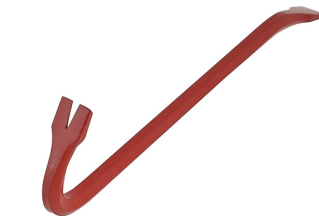

Made From Octagonal Steel
Cross Section With Hardened
& Tempered Chisel &
Claw Ends

Part No.	Size	Price
902 2120	18"	£10.12
902 2121	24"	£12.44
902 2122	30"	£14.05
902 2123	36"	£16.47

3" BRICK BOLSTER CHISEL



3" Bolster - Ideal for Cutting
Bricks During Building Work
Hardened Cutting Edge

Part No.	Price
902 2103	£7.00

CHISEL & POINT CROWBAR



Heavy Duty Crowbar
Drop Forged, High Quality
Steel

Length: 1.8m (72")

Part No.	Price
902 2128	£69.85

Wood Chisels

Full range of woodworking chisels available to order.
Please contact us for details

Tools

BALL PEIN HAMMERS



Ball Head Hammers with Hickory Handle Complete with Metal and Wooden Wedge

Part No.	Size	Price
902 2135	8oz	£13.58
902 2136	16oz	£17.05
FAIBPH24FG	24oz	£17.15
902 2138	32oz	£24.63

HICKORY CLAW HAMMER



16oz Carpenters Hammer with a Precision Ground and Hardened Curved Claw to Withstand the Most Heavy Nail Pulling

Part No.	Price
902 2155	£12.67

40Z CROSS PEIN HAMMER



Designed for Accurate Installation of Precision Fixings, such as Clips, Panel Pins etc.

Part No.	Price
902 2140	£10.78

FATMAX CLAW HAMMER



Stanley FatMax 16oz Anti-Vibration All Steel Claw Hammer

1 Piece Solid Forged Head Soft Grip Handle

STANLEY

Part No.	Price
902 2156	£36.05

CLUB HAMMERS



Contractors Club Hammers Hardened & Heat Treated Seasoned Hickory Handle

Part No.	Size	Price
902 2145	2. 1/2lb	£13.55
902 2146	4lb	£15.67

COPPER/RAWHIDE HAMMERS



THOR Hammers are a General-purpose, Soft-faced Hammer for Automotive & General Engineering Applications in Assembly, Repair & Maintenance

Part No.	Size	Price
902 2160	1"	£17.02
902 2161	1.1/2"	£31.40
902 2162	2"	£56.68

SLEDGE HAMMERS



Hardened, Heat Treated Striking Head Hickory Handle

Part No.	Description	Price
902 2150	7lb Sledge Hammer	£28.58
902 2151	14lb Sledge Hammer	£51.71
902 2152	30" Stale Only	£11.84
902 2153	36" Stale Only	£12.93

HAMMER STALES



Ball Head Hammers with Hickory Handle Complete with Metal and Wooden Wedge

Part No.	Size	Price
902 2170	12"	£3.60
902 2171	14"	£3.90
902 2172	16"	£4.40
110 130	5 Assorted Sizes	£18.94

Tools

BLACK RUBBER MALLET



THOR Rubber Mallets Are A One-Piece Design With Rubber Head And Self Locking Handle. These Semi-hard Rubber Mallets Give A Gentle But Firm Blow With Little Rebound.

Part No.	Size	Price
902 2175	64mm	£9.28
902 2176	74mm	£12.53

PAVERS RUBBER MAUL



Head:
330mm x 130mm Dia.
4.6kg

42" Ash Stale

Part No.	Price
902 2190	£61.77

MATTOCK



Ideal For Grubbing Out Tree Roots And Shrubs

Head Weight: 5lb

Part No.	Size	Price
902 2180	Mattock c/w Handle	£30.60
902 2181	Hardwood Handle Only	£13.65

PICK AXE



Pickaxe Head c/w 36" Hardwood Handle

Head Weight: 7lb

Part No.	Size	Price
902 2195	Pickaxe c/w Handle	£36.23
902 2196	Hardwood Handle Only	£26.54

POST HOLE DIGGER



Steel Oval Mouth Shovel Blades

Shaft Size: 12000mm
Blade Size: 250mm x 150mm

Part No.	Price
902 2185	£66.43

6" POST RAMMER



Heavy-Duty All-steel Post Rammer

Weight: 14.5kg
Height: 670mm
Post Size: 6"

Part No.	Price
902 2197	£96.20

TAPER MOUTH SHOVEL



Solid Manganese Steel Forged Blade And Socket Correctly Tempered For Strength Powder Coated For Rust Prevention

Part No.	Price
902 2187	£23.21

ROUND MOUTH SHOVEL



Carbon Steel Forged Blade with extra long socket for strength & stability

Blade size:
300 x 240mm

Part No.	Price
902 2198	£35.44

Groundworking, Landscaping & Gardening Tools

Full range of hand tools available for the groundworking, landscaping & gardening contractor. Budget range as well as professional brands such as Stihl and Bulldog available to order. Please contact us with your requirements or visit our website.

Tools

STAINLESS STEEL GARDEN FORK



Expert quality - stainless steel hardened & tempered head with ash handle

Part No.	Price
902 2211	£48.10

SECATEURS



Stihl bypass action secateurs

Aluminium body
Single hand clasp
length: 215mm

STIHL®

Part No.	Price
0000 881 3604	£12.80

STAINLESS STEEL GARDEN SPADE



Expert quality - stainless steel hardened & tempered head with ash handle

Part No.	Price
902 2226	£47.50

HEDGE SHEARS



Stihl coated serrated cutters with sap grooves
Beechwood handle
Impact absorber

STIHL®

Part No.	Price
0000 881 3671	£63.98

16L BACKPACK SPRAYER



16 litre Knapsack pressure sprayer
Shatterproof & frostproof
Pressure relief valve
Adjustable spray nozzle and trigger lock
'Pump on the move' feature
Spare parts available

Part No.	Price
FAISPRAY16	£53.71

PRUNING SHEARS



Stihl Bypass action pruning shears
Robust forged blades with internal oil lubrication
75cm aluminium handles with ergonomic grips

STIHL®

Part No.	Price
0000 881 3670	£61.38

SHARPENING STONE



Two sided with coarse & fine grain

Ideal for sharpening shears, axes, secateurs etc.

STIHL®

Part No.	Price
0000 881 6001	£14.05

PRUNING SAW



Stihl 32cm saw blade made from tempered carbon steel
Clustered teeth with clearing slots
Beechwood handle

STIHL®

Part No.	Price
0000 881 4111	£35.89

Tools

FLEXI BUCKET



Flexible Trug
Handles CE Tested
Re-inforced For Durability
Ribbed Profile For Strength

Size 42 Litre (9 Gal)

Part No.	Colour	Size	Price
FAIFLEX15Y	Yellow	15 Litre	£7.14
FAIFLEX15B	Black	15 Litre	£5.76
FAIFLEX28Y	Yellow	28 Litre	£11.97
FAIFLEX28B	Black	28 Litre	£8.75
902 2240	Yellow	42 Litre	£12.40
FAIFLEX42B	Black	42 Litre	£11.01
FAIFLEX60Y	Yellow	60 Litre	£19.56
FAIFLEX60B	Black	60 Litre	£13.04

WATERING CAN



Builders Bucket
With Handle & Pouring Lip,
Heavy Duty Polythene
14 Litres Capacity

Part No.	Price
902 2248	£9.75

BUILDERS BUCKET



Builders Bucket
With Handle & Pouring Lip,
Heavy Duty Polythene
14 Litres Capacity

Part No.	Price
902 2242	£2.90

WHEELBARROW



Press Pan Heavy Duty
Wheelbarrow

Pneumatic Tyre
85 Litre Capacity (3 cuft)

Part No.	Price
902 2250	£59.33

STANLEY ORGANISER



Stanley Sortmaster Organiser
Lid Lock
Stackable

43 x 33 x 8cm

STANLEY

Part No.	Price
902 2245	£15.82

STANLEY 18" OPEN TOTE BAG



Heavy Duty 600 Denier
Fabric With a Variety of
Internal & External Pockets

48 x 25 x 33cm

STANLEY

Part No.	Price
902 2255	£54.47

2 LEVEL ORGANISER



18 removable compartments
Top & bottom sections
Folding handle
Sturdy metal locking catches

455 x 240 x 145mm

Part No.	Price
902 2244	£39.48

STANLEY TOTE TRAY



Plastic Tote Tray
2 deep compartments plus
screwdriver and chisel slots
to keep tools well organised

50 x 34 x 20cm

STANLEY

Part No.	Price
902 2249	£9.23

Tools

19" BARN TYPE TOOLBOX



19" Barn Type Steel
Toolbox with Plastic
Tote Tray

Part No.	Price
902 2258	£33.39

THERMOPLASTIC TOOLBOXES



Impact Resistant
Polyethylene
Multi-point locking system
Reinforced Body & Lid
Water Resistant

Part No.	Size	Price
902 2263	700 x 250 x 300mm Tall	£152.40
902 2264	550 x 320 x 450mm Tall	£131.50

CANTILEVER TOOLBOXES



General Purpose Steel
Toolboxes

4 Cantilever Trays
Lockable Lid

Part No.	Size	Price
902 2260	17"	£57.45
902 2261	22"	£80.75

PISTOL GRIP BLOW GUN



PCL Pistol Grip Blow Gun
Moulded Special Acetalyc
Resin To Resist Damage.
For use with Air & Water

Max Pressure: 18 bar

AIR ENGRAVER



Air Engraver

Tungsten Carbide Tip for
Engraving Metals & Plastics
Complete with 4ft Air Line
1/4" BSP Female Nut

Part No.	Description	Price
902 2265	Air Engraver	£137.40
902 2266	Replacement Tip	£26.77

PCL BLOW GUN



PCL Blowgun with Safety
Nozzle
Die Cast Alloy
1/4" Inlet

Outlet Pressure: 28 psi

5 PIECE AIR TOOL KIT



5 Piece Air Tool Kit

1x Tyre inflator with pressure gauge
1x Blow out gun
1x Spiral air hose with
quick coupling
1x Oil spray gun with suction cup
1x Paint spray gun with gravity cup

Part No.	Price
902 2270	£36.00

Air Tools

Full range of workshop air tools available to order. Please contact us with your requirements.

Miscellaneous Tools

EMERGENCY HAMMER



Emergency Windscreen Hammer & Seatbelt Cutter
Shatters Windscreen & Domestic Glass
c/w Mounting Rack

Part No.	Price
902 2302	£11.52

CHALK LINE REEL 30M



Retractable Chalk Line with Fold Away Handle
Self Chalking Cotton Line

Length: 30m
30g Chalk Capacity

Part No.	Price
902 2320	£19.10

LADDER CLAMP SET



Quick & Safe Fixing of Ladders to Roof Racks
- Will Fix a Set of Triple Ladders
- No Tools Required
- Lockable

Part No.	Description	Price
902 2310	Pair of Clamps	£53.00
902 2311	Padlock to suit	£7.28

LINE CHALK



Line Chalk 250gms
For use with Chalk Line Reels

Part No.	Colour	Price
902 2330	Red	£4.93
902 2331	Blue	£4.93
902 2332	Yellow	£4.93
902 2333	White	£4.93

VALVE GRINDING STICK



PVC shaft with 19mm & 22mm diameter rubber suction ends

Part No.	Price
902 2315	£1.54

BALL PAINT MARKER



Marks With Real Paint
Dries in 5 Minutes
Marks on Smooth or Rough Surfaces
Weather And Fade Resistant

Part No.	Type	Colour	Price
200 7841	59ml Bottle	White	£10.16
200 7842	Aerosol Pen	White	£5.70
200 7851	59ml Bottle	Yellow	£10.05
200 7852	Aerosol Pen	Yellow	£5.70

CHEMICO GRINDING PASTE



Grinding Paste 100g Tin
Double Ended Tin
Fine & Coarse Paste

Part No.	Price
865 681	£2.25

240V ENGRAVER



Signograph 25 240v Hand Engraver for Marking Wood, Plastics, Metal & Ceramics

Supplied with 1 Hardened Steel Bit

Part No.	Description	Price
902 2350	240v Engraver	£33.30
902 2351	Hard Steel Tip	£5.80
902 2352	Signograph Tip Adapter	£2.69

HI VIS NYLON BRICK LINE



High visibility nylon brick lines
Easy to see on site

Length: 105m

Part No.	Description	Price
902 2355	Yellow	£7.95
902 2356	Pink	£7.95

Miscellaneous Tools

MAGNETIC PARTS TRAY



Magnetic Parts Tray
Round, 6" Diameter

Part No.	Price
902 2370	£6.59

CONCRETE TEST MOULDS



For Preparing Concrete Test
Specimens for Compression
Testing

MAGNETIC TOOL HOLDER SET

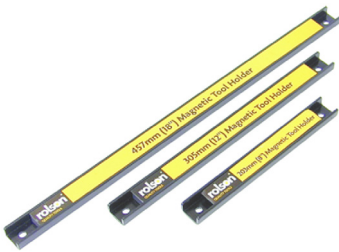

Holds All Kinds of Steel
Tools - Easily Wall Mounted

Contains 3 Sizes:
1 x 8", 1 x 12" & 1 x 18"

Part No.	Price
902 2375	£10.75

Part No.	Description	Price
902 2410	100x100x100mm Test Cube	£60.53
902 2411	150x150x150mm Test Cube	£81.38
902 2412	M10x35 Coach Bolt & Nut	£0.57
902 2413	M12x40 Coach Bolt & Nut	£1.04

MAGNETIC STRAP HOLDER



Powerful Magnetic Holder
50mm Diameter Hook &
Loop Strap for Holding Tools

Part No.	Price
902 2380	£5.87

CONCRETE CURING TANK



110v Plastic Concrete Curing Tank
ID: 970mm x 610mm x 610mm
Weight: 9kg

Comes With:
Galvanised Cube Support Rack
Mains Lead and Plug

Part No.	Price
902 2415	£289.40

MAGNETIC PICK-UP TOOL



165 x 635mm Telescopic Shaft

Ideal for Finding Lost Nuts,
Screws and Parts in Tight
Spaces, 3.6kg Capacity.

Part No.	Price
902 2396	£5.38

SLUMP CONE & ROD



Steel Slump Cone &
Tamping Rod

Part No.	Price
902 2425	£36.02

MAGNETIC PICK-UP TOOL



560mm Long Flexible Shaft
Powerful Magnet Will Lift
Approx 1.5kg

Part No.	Price
902 2395	£13.47

MOULD RELEASE OIL 5 LITRE



For Application to Concrete
Test Moulds, Shuttering etc.
Prior to Casting Concrete
Does not Stain

Part No.	Price
902 2535	£31.45

Makita Corded Power Tools

ANGLE GRINDER 115MM



Makita - GA4530R
115 mm (4-1/2") 720W
Angle Grinder, Anti-Restart
Function, Soft Start, Slide
Switch

Makita

Part No.	Voltage	Price
GA4530R110	110v	POA
GA4530R240	240v	POA

JIGSAW - 750 WATT



Makita - 4350FCT
720W Top Handle Jig Saw,
3 Orbital Settings Plus
Straight Cutting, LED Light.

Makita

Part No.	Voltage	Price
4350FCT110	110v	POA
4350FCT240	240v	POA

RECIPROCATING SAW



Makita - JR3050T
1,010W Reciprocating Saw

Makita

Part No.	Voltage	Price
JR3050T110	110v	POA
JR3050T240	240v	POA

PERCUSSION DRILL - 650 WATT



Makita - HP1640
16mm (5/8") 680W
Hammer Drill with Keyed
Chuck

Makita

Part No.	Voltage	Price
HP1640110	110v	POA
HP1640240	240v	POA

PERCUSSION DRILL - 850 WATT



Makita - HP2070
20mm (3/4") 1,010W 2-
Speed Hammer Drill with
Keyed Chuck

Makita

Part No.	Voltage	Price
HP2070110	110v	POA
HP2070240	240v	POA

SDS+ HAMMER DRILL



Makita - HR2630
26 mm (1") 2.4 J
Combination Hammer,
SDS-PLUS Bits

Makita

Part No.	Voltage	Price
HR2630110	110v	POA
HR2630240	240v	POA

Power Tools - Full range of power tools available from leading professional brands on our Website.

Makita
BOSCH

DEWALT

HiKOKI
HIGH PERFORMANCE POWER TOOLS

Milwaukee

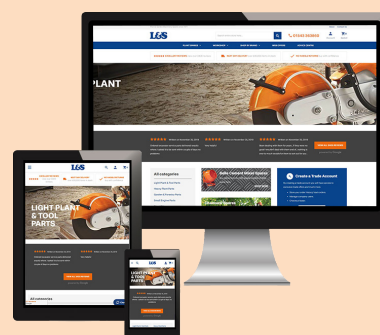

www.lsengineers.co.uk

Makita Cordless Power Tools

18V ANGLE GRINDER 115MM



Makita - DGA452Z
18V LXT Li-Ion Cordless
115 mm (4-1/2") Angle
Grinder, Anti-Restart
Function, Slide Switch
Lock-On

Makita

Part No.	Price
DGA452Z18	POA

18V JIGSAW - 750 WATT



Makita - DJV180Z
18V LXT Li-Ion Cordless
Top Handle Jig Saw, 3
Orbital Settings Plus
Straight Cutting, LED Light

Makita

Part No.	Price
DJV180Z18	POA

18V RECIPROCATING SAW



Makita - DJR186Z
18V LXT Li-Ion Cordless
Reciprocating Saw

Makita

Part No.	Price
DJR186Z18	POA

18V SDS+ HAMMER DRILL



Makita - DHR202Z
18V LXT Li-Ion Cordless
20 mm (13/16")
Combination Hammer,
SDS-PLUS Bits

Makita

Part No.	Price
DHR202Z18	POA

18V COMBI DRILL KIT



Makita - DHP482M1JW
18V LXT Combi Drill
Complete with 4.0Ah
Li-Ion Battery, Charger
and Makpac Case

Makita

Part No.	Price
DHP482RTWJ	POA

CHARGERS - LI-ION BATTERIES



Makita - Lithium-Ion
Battery Chargers

Makita

Part No.	Fits Model	Type	Price
DC10WA	BL1013	10.8V	POA
DC36RA	BL3626, BL3622	25.2-36V	POA
DC18SF	BL1860B, BL1830B	4 Port	POA
DC18SD	18V Li-Ion Batteries	18V	POA
DC18RD-240V	BL1860B, BL1830B	Twin 240V	POA
DC18RD-110V	BL1860B, BL1830B	Twin 110V	POA
DC18RC-240V	BL1860B, BL1830B	LXT 240V	POA
DC18RC-110V	BL1860B, BL1830B	LXT 110V	POA
DC18RE-240V	BL1860B, BL1830B	CXT/LXT Twin 240V	POA
DC18RE-110V	BL1860B, BL1830B	CXT/LXT Twin 110V	POA

LITHIUM-ION BATTERIES



Makita - Lithium-Ion
Batteries.

Makita

Part No.	BatteryModel	Volt	Amp-Hour	Price
194550-6	BL1013	10.8V	1.3ah	POA
197599-5	BL1830B	18V	3.0ah	POA
197265-4	BL1840B	18V	4.0ah	POA
197280-8	BL1850B	18V	5.0ah	POA
197422-4	BL1860B	18V	6.0ah	POA
195410-5	BL3622	36V	2.2ah	POA
638645-0	BL3626	36V	2.6ah	POA

Makita power tools are supplied without batteries unless stated otherwise.

Please see our website www.lsengineers.co.uk for latest offers.

Fencing / Scaffolding Accessories

SITE FENCING COUPLER



Temporary Site Fencing Coupler
Minimum 1 coupler per side or 2 per side for maximum stability

Part No.	Price
300 310	£1.55

FENCE/SCAFFOLD SPANNER



Scaffold & Harris Fence Clamp Spanner
Swing Over type
Universal Swivel Head
7/16" fitting

Part No.	Description	Price
300 311	Harris Fence/Scaffold Spanner	£11.55

SCAFFOLD LIGHT



4x LED Scaffolding / Skip Light
Polycarbonate Lens
Activated by Darkness
Alternative On/Off Switch
2x AA Batteries (Not Included)
30 Flashes Per Minute
200 Milliseconds Flash

Part No.	Description	Price
203 1404	Vertically Mounted	NLA
203 1403	Side-Mounted	£29.29

SCAFFOLD BOARD BANDS



Scaffold Board Bands / Hooping Irons
Metal End Plate for use on Standard Scaffold Boards.
Length - 550mm
(Sold Each)

Part No.	Price
300 312	£0.40

TOWER TAG KIT



Pack of Safety Tag Kits
10x Claw Tag Holders
20x Safety Tag Inserts
2x Pens

Part No.	Price
300 317	£44.70

SCAFFOLD TAG KIT



Pack of Safety Tag Kits
10x Claw Tag Holders
20x Safety Tag Inserts
2x Pens

Part No.	Price
300 315	£46.82

ANTI - THEFT PANEL SPANNER



Anti-Theft Panel Double Ended Spanner for Scaffolding and Harris Site Fencing Clamps
Shaped Security Spanner & 21mm Standard Spanner

Part No.	Description	Price
902 9100	Anti-Theft Panel Spanner	£21.50

TYVEK VIBRATION BAND

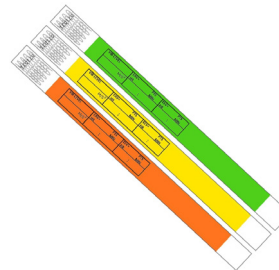

Vibration Bands Indicate the Safe Period of use for a Machine Where a Person may be at Risk from Prolonged Vibrations.

Part No.	Description	Quantity	Price
300 901	Amber	Single	£0.30
300 902	Yellow	Single	£0.30
300 903	Green	Single	£0.30
300 904	Amber	25 Pack	£4.95
300 905	Yellow	25 Pack	£4.95
300 906	Green	25 Pack	£4.95

Fencing / Scaffolding Accessories



Post Rammer 150mm (6in)

Faithfull large tubular steel post rammer with steel handles and reinforced top. This tool is used to knock in fence posts up to 150mm (6in) diameter. You slide the rammer over the post, then use the two handles to lift and drop the rammer onto the post, to knock it into the ground.

Max post capacity: 150mm
Length: 690mm
Weight: 15.4kg approx.

Part No.	Net Price
902 2197	£96.20

30" TRAFFIC CONE



Thermoplastic 30" Traffic Cone. Fitted with reflective sleeve. Cone and base manufactured in one piece from recycled thermoplastic. Conforms to BS EN 13422:2004

Part No.	Price
204 055	£9.55

MESH BARRIER FENCING

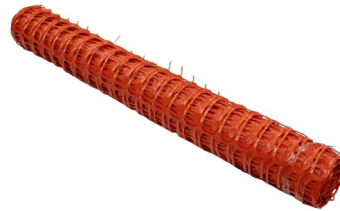

High Visibility Poly Barrier Fencing Mesh
Lightweight & Easy to Use

1m High x 50m Roll

Part No.	Description	Price
300 313	50m Roll Barrier Mesh	£36.50

PLASTIC BARRIER CHAIN



Red & White Plastic Barrier Chain

(Suits Part No. 888 661)

Part No.	Link	Length	Price
124 0121	6 x 41mm	5m	£9.75
124 0122	6 x 41mm	25m	£48.75
124 0117	8 x 52mm	5m	£17.15
124 0118	8 x 52mm	25m	£82.30
124 0119	10 x 64mm	5m	£19.76
124 0120	10 x 64mm	25m	£98.80

STEEL PIGTAIL SPIKE

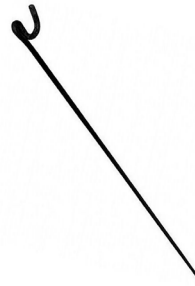

Steel pigtail spike for Poly Barrier Fencing Mesh

Length: 1350mm (53")
12mm Dia

Part No.	Description	Price (ea)
300 314	Pigtail Fencing Spike (1.35m)	£3.15

FREE STANDING CHAIN POST



Free Standing Chain Post c/w 4 Hooks For Chain
12" Round Plastic Hollow Base Foot (Can be filled with Water, Sand, etc.)

Post Height: 34"

Part No.	Price
888 661	£22.73

CAUTION MARKERS



Weatherproof Plastic Marker Bunting - 26m Length
Red & White Tags at 900mm Intervals

Part No.	Price
200 305	£24.36

Fasteners & Fixings

METRIC HT SETSCREWS

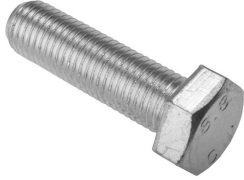

Metric HT Setscrows
Grade 8.8, Zinc Plated

Also Available in Self-Colour &
Stainless Steel

Part No.	Size	Pack	Price
903 0001	M5 x 16	200	£7.57
903 0002	M5 x 20	200	£7.15
903 0003	M5 x 25	200	£10.20
903 0004	M5 x 30	200	£9.93
903 0005	M5 x 40	200	£9.42
903 0006	M5 x 50	100	£8.28
903 0007	M6 x 12	200	£6.53
903 0008	M6 x 16	200	£5.92
903 0009	M6 x 20	200	£9.69
903 0010	M6 x 25	200	£8.43
903 0011	M6 x 30	200	£8.15
903 0012	M6 x 35	200	£9.97
903 0013	M6 x 40	200	£10.07
903 0014	M6 x 50	100	£6.02
903 0015	M6 x 60	50	£3.98
903 0016	M6 x 75	50	£5.13
903 0017	M7 x 25	200	£20.43
903 0018	M7 x 40	100	£18.03
903 0019	M8 x 16	200	£11.78
903 0020	M8 x 20	200	£13.83
903 0021	M8 x 25	200	£14.32
903 0022	M8 x 30	100	£7.58
903 0023	M8 x 35	100	£9.47
903 0024	M8 x 40	100	£9.95
903 0025	M8 x 45	100	£10.79
903 0026	M8 x 50	100	£11.35
903 0027	M8 x 60	100	£14.05
903 0028	M8 x 70	100	£15.97
903 0029	M8 x 75	50	£11.25
903 0030	M8 x 100	25	£12.02
903 0031	M10 x 20	200	£23.00
903 0032	M10 x 25	100	£12.33
903 0033	M10 x 30	100	£13.17
903 0034	M10 x 35	100	£14.90
903 0035	M10 x 40	100	£16.08
903 2612	M10 x 50	25	£4.68
903 0036	M10 x 50	50	£9.55
903 0037	M10 x 60	50	£11.55
903 0038	M10 x 75	50	£13.53
903 0039	M10 x 80	50	£18.66
903 0040	M10 x 100	25	£10.13
903 0041	M12 x 25	50	£9.63
903 0042	M12 x 30	50	£9.78
903 0043	M12 x 35	50	£10.90
903 0044	M12 x 40	50	£11.53
903 0045	M12 x 50	50	£13.62
903 0046	M12 x 60	25	£8.78
903 0047	M12 x 75	25	£9.97
903 0048	M12 x 100	25	£13.29
903 0049	M14 x 40	1	NLA

903 0050	M14 x 50	1	£0.51
903 0051	M14 x 60	1	£0.50
903 0052	M14 x 70	1	£0.50
903 0053	M16 x 30	1	£0.50
903 0054	M16 x 50	1	£0.50
903 0055	M16 x 75	1	£0.89
903 0056	M16 x 100	1	£0.90
105 192	Assorted Box - 295 Pieces Sizes: M6 16-50mm		£10.23
105 193	Assorted Box - 154 Pieces Sizes: M6 16-50mm		£10.95
105 194	Assorted Fasteners - 88 Pieces Sizes: M10 25-50mm		£11.10

UNF HT SETSCREWS



UNF HT Setscrows
Grade S, Zinc Plated

Part No.	Size	Pack	Price
903 0100	3/16 x 1	200	NLA
903 0101	3/16 x 1.1/2	200	£27.33
903 0102	1/4 x 1/2	200	£10.01
903 0103	1/4 x 3/4	200	£11.21
903 0104	1/4 x 1	200	£11.35
903 0105	1/4 x 1.1/2	200	£17.08
903 0106	1/4 x 2	200	£20.56
903 0107	1/4 x 3	100	NLA
903 0108	5/16 x 3/4	200	£15.07
903 0109	5/16 x 1	200	£17.15
903 0110	5/16 x 1.1/2	200	£22.42
903 0111	5/16 x 2	100	£16.23
903 0112	5/16 x 2.1/2	100	NLA
903 0113	5/16 x 3	100	£28.51
903 0114	3/8 x 3/4	100	£12.55
903 0115	3/8 x 1	100	£12.93
903 0116	3/8 x 1.1/2	100	£17.72
903 0117	3/8 x 2	50	£11.08
903 0118	3/8 x 2.1/2	50	£15.77
903 0119	3/8 x 3	50	£22.67
903 0120	7/16 x 1	50	NLA
903 0121	7/16 x 1.1/2	50	£11.70
903 0122	7/16 x 2	50	NLA
903 0123	7/16 x 3	25	NLA
903 0124	1/2 x 1.1/2	50	£15.84
903 0125	1/2 x 2	50	£19.43
903 0126	1/2 x 2.1/2	25	£11.63
903 0127	1/2 x 3	25	£24.25
903 0128	5/8 x 1.1/2	25	NLA
903 0129	5/8 x 2	25	£19.15
903 0130	5/8 x 3	25	£27.34
105 114	Assorted Box - 150 Pieces Sizes: 3/16 - 5/16"		£12.93

Fasteners & Fixings

UNC HT SETSCREWS



UNC HT Setscrows
Grade S, Zinc Plated

Part No.	Size	Pack	Price
903 0170	1/4 x 3/4	200	£12.80
903 0171	1/4 x 1	200	£14.48
903 0172	1/4 x 1.1/2	200	£17.89
903 0173	1/4 x 2	200	£22.81
903 0174	5/16 x 1	200	£17.94
903 0175	5/16 x 1.1/2	200	£23.10
903 0176	5/16 x 2	100	£16.32
903 0177	5/16 x 3	100	NLA
903 0178	3/8 x 1	100	£12.57
903 0179	3/8 x 1.1/2	100	£16.66
903 0180	3/8 x 2	50	£10.28
903 0181	3/8 x 3	50	£19.97
903 0182	1/2 x 1.1/2	50	£17.45
903 0183	1/2 x 2	50	£26.26
903 0184	1/2 x 3	25	£17.81

CAP HEAD SCREWS



Hex Socket Head Cap Screws
Grade 12.9 - Chemical Black

Also Available in Zinc Plated & Stainless Steel

Part No.	Size	Pack	Price
903 0280	M3 x 10	10	£0.75
903 0281	M4 x 10	10	£0.45
903 0282	M5 x 30	10	£0.90
903 0283	M5 x 35	10	£1.00
903 0284	M5 x 40	10	£1.10
903 0285	M5 x 50	10	£1.40
903 0286	M5 x 55	10	£1.55
903 0346	M6 x 10	200	£11.60
903 0347	M6 x 25	200	£16.60
903 0287	M6 x 35	10	£1.25
903 0288	M6 x 40	10	£1.40
903 0289	M6 x 45	10	£1.55
903 0290	M6 x 50	10	£1.65
903 0291	M6 x 60	10	£1.85
903 0292	M6 x 70	10	£2.15
903 0293	M6 x 80	10	£2.60
903 0294	M8 x 16	10	£1.45
903 0295	M8 x 20	10	£1.70
903 0296	M8 x 30	10	£2.15
903 0297	M8 x 45	10	£2.60
903 0298	M8 x 50	10	£2.08
903 0299	M8 x 55	10	£1.65
903 0300	M8 x 60	10	£2.06
903 0301	M8 x 70	10	£1.95
903 0302	M8 x 80	10	£2.53
903 0303	M10 x 20	10	£2.95
903 0304	M10 x 30	10	£3.45
903 0305	M10 x 40	10	£2.15
903 0306	M10 x 50	10	£2.85
903 0307	M10 x 60	10	£3.50
903 0308	M10 x 70	10	£3.20
903 0309	M10 x 80	10	£3.65
903 0310	M10 x 100	10	£4.25
903 0327	M10 x 130	10	£6.75
903 0311	M12 x 25	1	£0.25
903 0312	M12 x 50	1	£0.35
903 0313	M12 x 60	1	£0.59
903 0314	M12 x 70	1	£0.50
903 0315	M12 x 80	1	£0.55
903 0316	M12 x 100	1	£0.80
903 0317	M16 x 25	1	£0.85
903 0318	M16 x 40	1	£0.85
903 0319	M16 x 50	1	£1.15
903 0320	M16 x 75	1	£1.40
903 0321	M16 x 100	1	£1.70
903 0322	M20 x 50	1	£1.70
903 0323	M20 x 75	1	£1.70
903 0324	M20 x 100	1	£1.95
903 0325	M24 x 50	1	£1.95
903 0326	M24 x 100	1	£2.95

METRIC FLANGED SETSCREWS

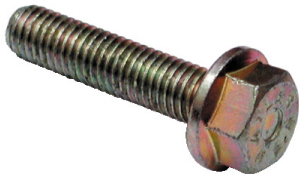

Metric HT Flanged Head
Setscrows
Grade 8.8
Zinc Passivated

Part No.	Size	Pack	Price
903 0210	M6 x 16	100	£9.90
903 0211	M6 x 20	100	£22.65
903 0212	M6 x 25	100	£12.30
903 0213	M8 x 20	100	£23.50
903 0214	M8 x 25	100	£25.40
903 0215	M8 x 35	100	£32.67
903 0216	M8 x 40	50	£18.30
903 0217	M10 x 35	50	£19.16

METRIC COACH BOLTS



Cup Square Head Coach Bolts
& Nuts, Zinc Plated

Other Sizes Available

Part No.	Size	Pack	Price
903 0260	M6 x 40	100	£8.90
903 0261	M6 x 75	100	£13.47
903 0259	M8 x 25	50	£10.48
903 0262	M8 x 40	50	£9.50
903 0263	M8 x 75	50	£10.25
903 0264	M10 x 40	50	£16.40
903 0265	M10 x 75	50	£14.50
903 0266	M12 x 50	50	£43.05
903 0267	M12 x 150	25	£35.92

Fasteners & Fixings

SOCKET SET (GRUB) SCREWS



Socket Set (Grub) Screws
Chemical Black

Other Sizes Available

Part No.	Size	Pack	Price
903 0350	M5 x 6	10	£0.25
903 0351	M5 x 10	10	£0.30
903 0352	M5 x 16	10	£0.45
903 0353	M6 x 6	10	£0.40
903 0354	M6 x 8	10	£0.35
903 0355	M6 x 10	10	£0.40
903 0356	M6 x 16	10	£0.65
903 0357	M6 x 20	10	£0.65
903 0358	M8 x 8	10	£0.65
903 0359	M8 x 10	10	£0.65
903 0360	M8 x 15	10	£0.97
903 0361	M8 x 20	10	£1.05
903 0365	M8 x 30	10	£1.43
903 0362	M10 x 10	10	£0.70
903 0363	M10 x 20	10	£1.65
903 0364	M10 x 25	10	£2.41

METRIC THREADED BAR



Metric Threaded Bar
Zinc Plated - 1m Lengths
Also Available in Stainless
Steel & Brass

Part No.	Size	Price (ea)
903 0390	M3	£1.21
903 0391	M4	£1.25
903 0392	M5	NLA
903 0393	M6	£0.90
903 0394	M8	£2.10
903 0395	M10	£2.55
903 0396	M12	£2.85
903 0397	M16	£5.62
903 0398	M20	£7.97
903 0399	M24	£9.46

METRIC STEEL NUTS



Plain Metric Steel Nuts

Zinc Plated

Part No.	Size	Pack	Price
903 0470	M3	200	£0.84
903 0471	M4	200	£1.48
903 0472	M5	200	£1.57
903 0473	M6	200	£2.33
903 0474	M7	200	£5.62
903 0475	M8	200	£4.50
903 0476	M10	100	£4.88
903 0477	M12	100	£7.10
903 0478	M14	50	£5.12
903 0479	M16	50	£6.67
903 0480	M20	25	£7.36
903 0482	M22	25	£15.31
903 0481	M24	10	£8.23
903 0483	M30	5	£10.08
105 220	Assorted Box - 370 Pieces Sizes: M6 - M12		£10.23

200 ASSORTED NUT CAPS

200 x Assorted Black Nut Caps



Low density polyethylene (LDPE)
Push Fit
Covers exposed nuts and bolts
Safe and professional finish

5mm x 50
6mm x 50
8mm x 50
10mm x 30
12mm x 20

Part No.	Price
903 0275	£15.83

NUT CAPS



Low density polyethylene (LDPE)
Push fit allows a neat finish
For covering exposed nuts and
bolts offering a safe and
professional finish.

Part No.	Size	Price (50PK)
903 0269	M5	£2.75
903 0271	M6	£3.98
903 0272	M8	£4.05
903 0273	M10	£4.15
903 0274	M12	£5.40

UNF STEEL NUTS



Plain UNF Steel Nuts
Zinc Plated

Also Available in Stainless

Part No.	Size	Pack	Price
903 0520	3/16"	200	£2.76
903 0521	1/4"	200	£3.79
903 0522	5/16"	200	£7.22
903 0523	3/8"	200	£16.98
903 0524	7/16"	100	£7.72
903 0525	1/2"	100	£9.48
903 0526	5/8"	50	£9.92
903 0527	3/4"	25	£8.59
105 115	Assorted Box - 300 Pieces Sizes: 3/16" - 3/8"		£11.48

Fasteners & Fixings

UNC STEEL NUTS



Plain UNC Steel Nuts
Zinc Plated

Also Available in Stainless

Part No.	Size	Pack	Price
903 0551	1/4"	200	£7.82
903 0552	5/16"	200	£7.30
903 0553	3/8"	200	£8.20
903 0554	7/16"	100	£9.50
903 0555	1/2"	100	£12.41
903 0556	5/8"	50	£16.60
105 118	Assorted Box - 300 Pieces Sizes: 1/4" - 3/8"		£15.75

UNC NYLOC NUTS



UNC Nylon Insert Locking Nuts
'P' Type - Zinc Plated

Also Available in Stainless

Part No.	Size	Pack	Price
903 0650	1/4"	100	£3.99
903 0651	5/16"	100	£3.71
903 0652	3/8"	100	£5.37
903 0653	7/16"	100	£7.91
903 0654	1/2"	100	£14.82
903 0655	5/8"	50	£13.04
903 0656	3/4"	25	£11.80

METRIC NYLOC NUTS



Metric Nylon Insert Locking Nuts
DIN 982 ('P' Type) - Zinc Plated

Also Available in Stainless

Part No.	Size	Pack	Price
903 0580	M3	200	NLA
903 0581	M4	200	£2.68
903 0582	M5	200	£3.12
903 0583	M6	100	£2.25
903 0584	M8	100	£3.80
903 0585	M10	100	£7.58
903 0586	M12	100	£10.98
903 0587	M14	50	£8.27
903 0588	M16	25	£5.70
105 121	Assorted Box - 220 Pieces Sizes: M5 - M12		£11.47

METRIC FLANGED NUTS



Metric Serrated Flange Nuts
Zinc Plated

Also Available in Stainless

Part No.	Size	Pack	Price
903 0680	M5	100	£1.55
903 0681	M6	100	£2.20
903 0682	M8	100	£4.85
903 0683	M10	50	£3.40
903 0684	M12	50	£6.68
903 0685	M14	50	£36.97
903 0686	M16	25	£44.50
105 195	Assorted Box - 225 Pieces Sizes: M5 - M12		£10.53

UNF NYLOC NUTS



UNF Nylon Insert Locking Nuts
'P' Type - Zinc Plated

Also Available in Stainless

Part No.	Size	Pack	Price
903 0620	No. 10	200	£4.10
903 0621	1/4"	100	£3.36
903 0622	5/16"	100	£3.81
903 0623	3/8"	100	£5.57
903 0624	7/16"	100	£7.14
903 0625	1/2"	50	£6.66
903 0626	5/8"	50	£13.46
903 0627	3/4"	25	£10.77
105 116	Assorted Box - 220 Pieces Sizes: 1/4" - 1/2"		£12.37

METRIC S/STEEL NUTS

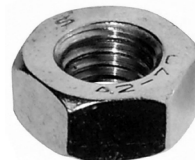

Metric Plain Nuts - Stainless
Steel

Part No.	Size	Pack	Price
903 0720	M3	200	£2.30
903 0721	M4	250	£4.94
903 0722	M5	100	£2.87
903 0723	M6	100	£4.62
903 0724	M8	50	£5.15
903 0725	M10	25	£5.72
903 0726	M12	25	£6.91
903 0728	M16	25	£14.28
903 0729	M20	25	£14.20

Fasteners & Fixings

DOME NUTS



Dome Nuts - Zinc Plated

Also Available in Stainless Steel

Part No.	Size	Pack	Price
903 0740	M4	50	£1.53
903 0741	M5	50	£1.91
903 0742	M6	25	£1.42
903 0743	M8	25	£3.70
903 0744	M10	25	£2.60
903 0745	M12	10	£1.50
903 0746	M16	5	£2.90
903 0747	M20	1	£0.70

LEFT HAND NUTS



Metric Left Hand Threaded Nuts
Self Colour

Part No.	Size	Price (ea)
903 0820	M6	NLA
903 0821	M8	£1.82
903 0822	M10	£0.91
903 0823	M12	£1.55
903 0824	M16	£1.30
903 0825	M20	£1.80
903 0826	M24	£2.85

WING NUTS



Wing Nuts - Zinc Plated

Also Available in Stainless Steel

Part No.	Size	Pack	Price
903 0760	M4	10	£0.66
903 0761	M5	10	£0.55
903 0762	M6	10	£0.65
903 0763	M8	10	£0.85
903 0764	M10	10	£2.05
903 0765	M12	10	£1.65
903 0766	M16	10	£5.17

FORM A FLAT WASHERS



Heavy Duty, Form A Flat
Washers - Zinc Plated
BS4320

Part No.	I.D.	Pack	Price
903 0835	3mm	1000	£3.82
903 0836	4mm	1000	£6.62
903 0837	5mm	1000	£4.77
903 0838	6mm	500	£3.70
903 0839	8mm	500	£6.78
903 0840	10mm	500	£12.45
903 0841	12mm	250	£10.60
903 0842	14mm	150	£9.78
903 0843	16mm	100	£7.53
903 0844	20mm	100	£8.65
903 0845	24mm	25	£9.14
903 0847	30mm	25	£13.67
105 125	Assorted Box - 800 Pieces Sizes: M5 - M16		£11.62

U NUTS



U Nuts - Zinc Plated

Part No.	Size	Pack	Price
903 0780	No. 6	100	£18.71
903 0781	No. 8	100	£3.53
903 0782	No. 10	100	£5.80
903 0783	No. 12	100	£10.62
903 0784	No. 14	100	£8.00

FORM C FLAT WASHERS



Heavy Duty, Form C (Large O.D.)
Flat Washers - Zinc Plated
BS4320

Part No.	I.D.	Pack	Price
903 0880	5mm	1000	£4.37
903 0881	6mm	500	£4.98
903 0882	8mm	500	£10.40
903 0883	10mm	250	£6.70
903 0884	12mm	250	£11.43
903 0885	14mm	100	£5.68
903 0886	16mm	100	£9.53
903 0887	20mm	100	£9.60
903 0888	24mm	100	£21.61
105 124	Assorted Box - 800 Pieces Sizes: M5 - M20		£19.70

J NUTS



J Nuts - Zinc Plated

Part No.	Size	Pack	Price
903 0795	No. 8	100	£6.48
903 0796	No. 10	100	£8.30
903 0797	No. 12	100	£8.17
903 0798	No. 14	100	£8.77

Fasteners & Fixings

TABLE 3 FLAT WASHERS

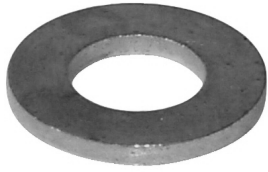
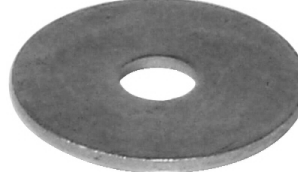

Table 3 Flat Washers
Zinc Plated

Part No.	I.D.	Pack	Price
903 0920	3/16"	1000	£8.10
903 0921	1/4"	500	£5.48
903 0922	5/16"	500	£6.91
903 0923	3/8"	500	£11.22
903 0924	7/16"	250	£8.06
903 0925	1/2"	250	£11.62
903 0926	9/16"	200	£17.55
903 0927	5/8"	100	£8.35
903 0928	3/4"	100	£13.29
903 0929	7/8"	100	£17.57
903 0930	1"	100	£30.82
105 126	Assorted Box - 800 Pieces Sizes: 3/16" - 1/2"		£12.73

REPAIR WASHERS



Repair Washers
Zinc Plated

Part No.	I.D.	O.D.	Pack	Price
903 1001	3/16"	1"	200	£6.55
903 1002	3/16"	1.1/2"	200	£15.14
903 1003	1/4"	1"	200	£5.85
903 1004	1/4"	1.1/2"	200	£13.02
903 1005	5/16"	1"	200	£6.61
903 1006	5/16"	1.1/2"	200	£12.74
903 1007	3/8"	1.1/2"	200	£11.85
903 1008	3/8"	2"	100	£12.51
903 1009	5/16"	2"	100	£14.37
903 1010	3/8"	1.1/2"	100	£7.20
903 1011	1/2"	2"	50	£11.61
105 130	Assorted Box - 230 Pieces i.d. 3/16" - 3/8"			£12.90

FORM A S/STEEL WASHERS



Heavy Duty, Form A Flat
Washers - Stainless Steel

Part No.	I.D.	Pack	Price
903 0960	3mm	500	£4.18
903 0961	4mm	500	£3.50
903 0962	5mm	200	£2.53
903 0963	6mm	100	£1.85
903 0964	8mm	100	£3.75
903 0965	10mm	50	£2.45
903 0966	12mm	50	£4.26
903 0967	16mm	50	£9.88
903 0968	20mm	50	£11.50
903 0969	24mm	50	£14.95

METRIC SPRING WASHERS



Metric Spring Washers
Rectangular Section
Zinc Plated

Part No.	I.D.	Pack	Price
903 1050	5mm	1000	£3.96
903 1051	6mm	500	£4.92
903 1052	8mm	500	£6.56
903 1053	10mm	500	£9.64
903 1054	12mm	250	£8.08
903 1055	16mm	100	£4.75
903 1057	14mm	100	£5.72
903 1056	20mm	50	£6.93
105 128	Assorted Box - 800 Pieces Sizes: M5 - M16		£9.82

FORM C S/STEEL WASHERS



Heavy Duty, Form C (Large O.D.)
Flat Washers - Stainless Steel

Part No.	I.D.	Pack	Price
903 0980	6mm	500	£13.30
903 0981	8mm	500	£28.39
903 0982	10mm	200	£19.31
903 0983	12mm	100	£15.62
903 0984	16mm	100	£21.16
903 0985	20mm	100	£22.60

IMPERIAL SPRING WASHERS



Imperial Spring Washers
Rectangular Section
Zinc Plated

Part No.	I.D.	Pack	Price
903 1080	3/16"	1000	£4.30
903 1081	1/4"	500	£4.92
903 1082	5/16"	500	£8.80
903 1083	3/8"	500	£15.71
903 1084	7/16"	250	£6.93
903 1085	1/2"	250	£12.70
903 1086	5/8"	100	£10.41
903 1087	3/4"	100	£12.40

Fasteners & Fixings

INTERNAL CIRCLIPS



Internal Circlips

Part No.	Size	Price (ea)
903 1210	12mm	£0.05
903 1212	14mm	£0.40
903 1213	16mm	NLA
903 1214	18mm	£0.05
903 1215	22mm	NLA
903 1217	25mm	£0.08

EXTERNAL CIRCLIPS



External Circlips

Part No.	Size	Price (ea)
903 1230	12mm	£0.10
903 1232	14mm	£0.10
903 1233	16mm	£0.10
903 1234	18mm	£0.10
903 1236	24mm	£0.40
903 1237	25mm	£0.25

FIBRE WASHERS



Fibre Washers
Quantity: 610

Sizes: 13/64" x 3/8", 1/4" x 3/8",
3/8" x 5/8", 13/32" x 5/8", 29/64"
x 11/16", 1/2" x 3/4", 5/8" x 7/8",
49/64" x 15/16"

Part No.	Price
105 131	£21.53

LOCK WASHERS



Internal & External Lock Washers
Quantity: 1000

i.d. Sizes: 3/16", 1/4", 5/16", 3/8",
7/16", 1/2"

Part No.	Price
105 129	£17.95

SQUARE PLATE WASHERS



Square Plate Washers
Round Hole
(subject to availability)

Part No.	Hole	Size	Thick	Price (ea)
903 1196	M8	1.1/2"	3mm	POA
903 1181	M10	1.1/2"	3mm	£0.55
903 1182	M10	2"	3mm	£0.35
903 1183	M10	3"	3mm	£0.79
903 1184	M12	1.1/2"	3mm	£0.40
903 1185	M12	2"	3mm	£0.35
903 1186	M12	3"	3mm	£0.98
903 1187	M16	2"	3mm	£0.36
903 1188	M16	3"	3mm	£0.95
903 1189	M20	2"	3mm	£0.50
903 1190	M20	3"	3mm	£1.05
903 1191	M16	3"	6mm	£1.95
903 1192	M16	4"	6mm	£1.95
903 1193	M20	3"	6mm	£1.69
903 1194	M24	3"	6mm	£3.00
903 1195	M24	4"	6mm	£2.83

Washers

Full range of washers available including flat, compression & sump washers in metric and imperial sizes.
Please check the website for details - www.lsengineers.co.uk

Fasteners & Fixings

E CLIPS



E Retainer Clips

Part No.	Size	Price (ea)
903 1250	1.5mm	£0.12
903 1251	2.3mm	NLA
903 1254	5mm	£0.12
903 1255	6mm	£0.12
903 1256	8mm	£0.12
903 1257	10mm	£0.12
903 1258	12mm	£0.12
105 430	Assorted Box - 620 Pieces Sizes: 1.5mm - 15mm	£8.23
105 142	Assorted Box - 800 Pieces Sizes: 1.5mm - 15mm	£11.00

METRIC O RINGS



Metric Rubber O Rings

Larger Sizes Available

Part No.	I.D.	Thickness	Pack	Price
903 1285	3mm	2.0mm	50	£1.07
903 1286	4mm	2.0mm	50	£1.01
903 1287	5mm	2.0mm	50	£1.07
903 1288	6mm	2.0mm	50	£1.36
903 1289	7mm	2.0mm	50	£0.96
903 1290	8mm	2.0mm	50	£1.31
903 1291	10mm	2.0mm	50	£1.42
903 1292	10mm	2.5mm	50	£1.65
903 1293	11mm	2.5mm	50	£1.56
903 1294	12mm	2.5mm	50	£1.65
903 1295	14mm	2.5mm	50	£1.60
903 1296	16mm	2.5mm	50	£2.04
903 1297	17mm	2.5mm	25	£0.85
903 1298	19mm	2.5mm	25	£1.14
903 1299	19mm	3.0mm	25	£1.36
903 1300	22mm	3.0mm	12	£1.64
903 1301	24mm	3.0mm	12	£1.64
903 1302	25mm	3.0mm	12	£0.88

METRIC O RING SET



Metric Rubber O Rings
Yellow Box Set - 404 Pieces

Sizes: 3mm - 44mm

Part No.	Price
105 171	£17.87

IMPERIAL O RING SET



Imperial Rubber O Rings
Red Box Set - 382 Pieces

Sizes: 2.9mm to 43.82mm

Part No.	Price
105 158	£14.80

O RING SPLICING KIT



Rubber 'O' Ring Service Kit

Kit Contains:
1/16", 3/32", 1/8", 3/16", 1/4",
1.6mm, 2.0mm, 3.0mm, 4.0mm,
5.0mm & 5.7mm Dia. Nitrile O Ring
Cord In 2m Packs, Cutting Block,
Cutter, Adhesive & Instructions

Part No.	Price
895 100	£34.21

Fasteners & Fixings

METRIC SPLIT PINS



Metric Split Cotter Pins
Zinc Plated

Part No.	Diam.	Length	Pack	Price
903 1360	1.6mm	32mm	500	£12.39
903 1361	2.0mm	40mm	500	£12.48
903 1362	2.5mm	40mm	500	£14.16
903 1363	3.2mm	32mm	250	£9.12
903 1364	3.2mm	40mm	250	£8.75
903 1365	3.2mm	50mm	200	£8.27
903 1366	4.0mm	32mm	200	£7.02
903 1367	4.0mm	50mm	200	£12.73
903 1368	5.0mm	40mm	100	£8.54
903 1369	5.0mm	50mm	100	£8.95
105 140	Assorted Box - 600 Pieces Sizes: 1.6mm - 5mm			£19.00

METRIC ROLL PINS



Metric Spring Steel Roll Pins

Part No.	Diam.	Length	Pack	Price
903 1460	2.5mm	24mm	100	£2.38
903 1461	2.5mm	40mm	100	£4.19
903 1462	3mm	40mm	100	£4.67
903 1463	4mm	40mm	50	£2.07
903 1464	5mm	40mm	50	£2.84
903 1465	6mm	40mm	25	£2.29
903 1466	8mm	24mm	25	£2.62
903 1467	8mm	55mm	20	£3.87
105 136	Assorted Box - 300 Pieces Sizes: 2.5mm - 8mm			£17.58

IMPERIAL SPLIT PINS



Imperial Split Cotter Pins
Zinc Plated

Part No.	Diam.	Length	Pack	Price
903 1390	1/16"	1"	500	£8.13
903 1391	1/16"	2"	500	£19.34
903 1392	5/64"	1"	500	£13.23
903 1393	5/64"	1.1/2"	500	£16.65
903 1394	3/32"	1.1/2"	500	£10.88
903 1395	7/64"	1.1/2"	500	£25.51
903 1396	7/64"	2"	500	£21.05
903 1397	1/8"	1.1/2"	500	£13.22
903 1398	1/8"	2.1/4"	500	£23.05
903 1399	9/64"	1.1/2"	500	£16.78
903 1400	9/64"	2.1/4"	500	£27.92
903 1401	3/32"	1.1/2"	350	£9.18
903 1402	5/32"	1.5/8"	200	£8.70
903 1403	5/32"	2.1/4"	200	£15.05
903 1404	5/32"	3"	200	£16.39
903 1405	11/64"	2"	200	£30.67
903 1406	3/16"	2"	200	£14.83
903 1407	3/16"	3"	100	£11.00
903 1408	1/4"	3"	100	£13.68
903 1409	5/16"	3"	100	£29.57
903 1410	7/32"	2.3/4"	100	£11.97
903 1411	7/32"	3"	100	£22.07
105 134	Assorted Box - 1000 Pieces Sizes: 1/16" - 5/32"			£22.65

IMPERIAL ROLL PINS



Imperial Spring Steel Roll Pins

Part No.	Diam.	Length	Pack	Price
903 1496	1/4"	1"	50	£3.65
903 1497	1/4"	2"	25	£4.48
105 185	Assorted Box - 385 Pieces Sizes: 3/32" - 5/16"			£22.61

CLEVIS PINS



Clevis Pins
Zinc Plated

Part No.	Diam.	Length	Pack	Price
903 1530	6mm	20mm	50	£12.78
903 1531	3/16"	5/8"	50	£8.37
903 1532	3/16"	7/8"	50	£11.36
903 1533	1/4"	1/2"	50	£22.59
903 1534	1/4"	11/16"	50	£11.78
903 1535	5/16"	7/8"	50	£12.93
903 1536	5/16"	1"	50	£14.17
903 1537	3/8"	1.1/4"	50	£25.14
105 135	Assorted Box - 175 Pieces Sizes: 3/16" - 3/8"			£54.47

Fasteners & Fixings

POP RIVETS - STD FLANGE



POP Rivets, Standard Flange
Aluminium

Part No.	Diam.	Length	Pack	Price
903 1580	3.2mm (1/8")	10mm	500	£21.30
903 1581	3.2mm (1/8")	14mm	500	£20.97
903 1582	4.0mm (5/32")	13mm	500	£12.50
903 1583	4.0mm (5/32")	16mm	500	£28.87
903 1584	4.8mm (3/16")	14mm	500	£33.14
903 1585	4.8mm (3/16")	19mm	500	£32.89
903 1586	4.8mm (3/16")	28mm	200	£11.79
105 188	Assorted Box - 350 Pieces Sizes: 1/8" - 3/16"			£11.66

POP RIVETS - LARGE FLANGE



POP Rivets, Large Flange
Aluminium

Part No.	Diam.	Length	Pack	Price
903 1610	4.8mm (3/16")	14mm	200	£20.62
903 1611	4.8mm (3/16")	20mm	200	£17.60
903 1612	4.8mm (3/16")	24.8mm	200	£12.74

RIVET WASHERS



Rivet Washers
Zinc Plated

Part No.	I.D.	O.D.	Pack	Price
903 1625	1/8"	1/2"	1000	£12.26
903 1626	3/16"	3/4"	200	£4.20

LAZY TONG RIVETER



Lazy Tong Riveter
Suitable For use with
3.2, 4.0 & 4.8mm Rivets

Part No.	Description	Price
903 1635	Lazy Tong Riveter	£81.90
903 1636	Repair Kit	£17.27

HEAVY DUTY RIVET GUN



Heavy Duty Hand Rivet Gun
Suitable For use with
3.2, 4.0 & 4.8mm Rivets

Part No.	Price
903 1640	£27.77

RIVET GUN NOZZLES



For Lazy Gun & Heavy Duty
Rivet Guns

Part No.	Size	Price (ea)
903 1650	3.2mm (1/8")	£1.73
903 1651	4.0mm (5/32")	£1.60
903 1652	4.8mm (3/16")	£1.70

NUTSERT KIT



Threaded Insert Tool Kit

Includes A Selection Of Popular
Size Nutserts & Nose Bush /
Mandrel Kits: 4, 5, 6, 8mm

Part No.	Price
903 1670	£69.08

NUTSERTS



Smooth Body Threaded Nutserts

For repairing worn out threads

Part No.	Size	Pack	Price
903 1675	3mm	50	£4.83
903 1676	4mm	50	£5.90
903 1677	5mm	50	£6.30
903 1678	6mm	50	£7.80
903 1679	8mm	50	£10.50

Fasteners & Fixings

NUMBER PLATE FIXINGS



Nylon Nuts & Bolts
1" Long Slotted Nylon Bolts

Part No.	Colour	Pack	Price
903 1690	White	100 Sets	£5.74
903 1691	Yellow	100 Sets	£5.74
903 1692	Black	100 Sets	£5.74

NUMBER PLATE FIXINGS



Cap, Dome & Screws
PZD Self Tapping Screws
8 x 3/4"
Zinc Plated

Part No.	Colour	Pack	Price
903 1710	White	100 Sets	£7.38
903 1711	Yellow	100 Sets	£7.33
903 1712	Black	100 Sets	£7.60

NUMBER PLATE FIXINGS



'Flip Top' Screws
PZD Self Tapping Screws
8 x 3/4"
Zinc Plated

Part No.	Colour	Pack	Price
903 1725	White	100 Sets	£4.80
903 1726	Yellow	100 Sets	£4.80
903 1727	Black	100 Sets	£4.80

PLASTIC WALL PLUGS



Plastic Wall Plugs

Part No.	Colour	Screw	Pack	Price
903 1750	Yellow	No. 4-10	100	POA
903 1751	Red	No. 6-12	100	£6.51
903 1752	Brown	No. 10-14	100	£2.00

SELF TAPPERS - PZD PAN HEAD



Self Tapping Screws
Pozidriv, Pan Head, AB Point
Zinc Plated
BS4174

Part No.	Size	Length	Pack	Price
903 1781	2	5/16"	1000	NLA
903 1782	4	3/8"	1000	£4.50
903 1783	4	1/2"	1000	£9.50
903 1785	6	1/4"	1000	£5.11
903 1786	6	3/8"	1000	£5.48
903 1787	6	1/2"	1000	£6.75
903 1788	6	5/8"	1000	£6.67
903 1789	6	3/4"	1000	£10.19
903 1790	6	1"	1000	£10.26
903 1791	8	3/8"	1000	NLA
903 1792	8	1/2"	1000	£11.30
903 1793	8	5/8"	1000	£8.60
903 1794	8	3/4"	1000	£12.63
903 1795	8	1"	1000	£14.80
903 1796	8	1.1/4"	1000	£14.20
903 1797	8	1.1/2"	1000	£17.33
903 1798	8	2"	500	£12.43
903 1799	10	1/2"	1000	£11.13
903 1800	10	5/8"	1000	£19.47
903 1801	10	3/4"	1000	£14.47
903 1802	10	1"	1000	£24.95
903 1803	10	1.1/4"	1000	£21.89
903 1804	10	1.1/2"	500	£12.46
903 1805	10	2"	500	£17.37
903 1806	12	1/2"	500	£14.73
903 1807	12	1"	1000	£29.17
903 1808	12	1.1/2"	500	£16.74
903 1809	14	3/4"	1000	£30.99

ASSORTED PAN HEAD SCREWS



Self Tapping Screws
Pozidriv, Pan Head, AB Point
Zinc Plated
BS4174

Part No.	Sizes	Pack	Price
105 102	4-10	700	£9.96
105 104	8-12	330	£10.15
105 226	4-12	600	£9.36

Fasteners & Fixings

SELF TAPPERS - PZD C/SUNK



Self Tapping Screws
Pozidriv, Countersunk Head,
AB Point, Zinc Plated
BS4174

Part No.	Size	Length	Pack	Price
903 1860	No. 4	3/8"	1000	£4.79
903 1861	No. 4	1/2"	1000	£4.44
903 1862	No. 6	1/2"	1000	£5.80
903 1863	No. 6	5/8"	1000	£7.42
903 1864	No. 6	3/4"	1000	£6.50
903 1865	No. 6	1"	1000	£11.83
903 1866	No. 6	1.1/4"	1000	£10.87
903 1867	No. 6	1.1/2"	1000	£12.05
903 1868	No. 8	3/8"	1000	£7.85
903 1869	No. 8	1/2"	1000	£8.06
903 1870	No. 8	5/8"	1000	£11.80
903 1871	No. 8	3/4"	1000	£11.02
903 1872	No. 8	1"	1000	£13.45
903 1873	No. 8	1.1/4"	1000	£14.52
903 1874	No. 8	1.1/2"	1000	£8.45
903 1875	No. 8	1.3/4"	500	£10.26
903 1876	No. 8	2"	500	£12.43
903 1877	No. 10	3/4"	1000	£11.96
903 1878	No. 10	1"	1000	£14.77
903 1879	No. 10	1.1/4"	1000	£23.70
903 1880	No. 10	1.1/2"	500	£12.05
903 1881	No. 10	2"	500	£18.06
903 1882	No. 12	1.1/2"	500	£16.51
105 107	Assorted Box - 615 Pieces Sizes: 6 - 10			£11.95

TWINTHREAD WOOD SCREWS



Hardened Wood Screws
Pozidriv, Countersunk Head,
Zinc Plated

Part No.	Size	Length	Pack	Price
903 1920	No. 4	1/2"	200	£0.92
903 1921	No. 4	5/8"	200	£0.98
903 1922	No. 4	3/4"	200	£1.06
903 1923	No. 4	1"	200	£1.22
903 1924	No. 5	1/2"	200	£1.40
903 1925	No. 5	5/8"	200	£1.24
903 1926	No. 5	3/4"	200	£1.36
903 1927	No. 6	1/2"	200	£1.14
903 1928	No. 6	5/8"	200	£1.24
903 1929	No. 6	3/4"	200	£1.46
903 1968	No. 6	1"	200	£1.71
903 1930	No. 6	1.1/4"	200	£2.05
903 1931	No. 6	1.1/2"	200	£2.45
903 1932	No. 6	1.3/4"	200	£2.50
903 1933	No. 6	2"	200	£2.98
903 1934	No. 7	5/8"	200	£1.62
903 1935	No. 7	3/4"	200	£1.82
903 1936	No. 7	1"	200	£2.00
903 1937	No. 7	1.1/4"	200	£2.51
903 1938	No. 7	1.1/2"	200	£2.55
903 1939	No. 8	1/2"	200	£1.34
903 1940	No. 8	5/8"	200	£1.48
903 1941	No. 8	3/4"	200	£1.82
903 1942	No. 8	1"	200	£2.20
903 1943	No. 8	1.1/4"	200	£2.49
903 1944	No. 8	1.1/2"	200	£2.50
903 1945	No. 8	1.3/4"	200	£3.07
903 1946	No. 8	2"	200	£3.48
903 1947	No. 8	2.1/4"	200	£4.25
903 1948	No. 8	2.1/2"	200	£4.43
903 1949	No. 8	3"	200	£5.88
903 1950	No. 10	3/4"	200	£2.51
903 1951	No. 10	1"	200	£2.80
903 1952	No. 10	1.1/4"	200	£3.10
903 1953	No. 10	1.1/2"	200	£3.83
903 1954	No. 10	1.3/4"	200	£4.20
903 1955	No. 10	2"	200	£4.82
903 1956	No. 10	2.1/4"	200	£5.52
903 1957	No. 10	2.1/2"	200	£5.97
903 1958	No. 10	3"	200	£6.95
903 1959	No. 10	3.1/2"	100	£4.35
903 1960	No. 10	4"	100	£4.82
903 1961	No. 12	1"	200	£4.07
903 1962	No. 12	1.1/4"	200	£4.48
903 1963	No. 12	1.1/2"	200	£5.12
903 1964	No. 12	2"	200	£6.17
903 1965	No. 12	3"	200	£9.40
903 1966	No. 12	4"	100	£6.38

CONCRETE SCREWS



Concrete Frame Screws - T30
Torx Head
Zinc/Yellow Passivated
Supplied with 1 Bit Per Box

Part No.	Size	Pack	Price
903 1985	7.5 x 40	100	£5.18
903 1986	7.5 x 50	100	£5.80
903 1987	7.5 x 60	100	£6.60
903 1988	7.5 x 70	100	£7.33
903 1989	7.5 x 80	100	£8.13
903 1990	7.5 x 90	100	£8.98
903 1991	7.5 x 100	100	£9.82
903 1992	7.5 x 110	100	£11.13
903 1993	7.5 x 120	100	£12.58
903 1994	7.5 x 130	100	£14.28
903 1995	7.5 x 150	100	£15.62
903 1996	7.5 x 180	100	£19.65
903 1997	7.5 x 200	100	£22.87

Fasteners & Fixings

HEX S/DRILLING SCREW



Hexagon Head Self Drilling
Roofing/Panel Fixing Screws
Light Section Steel (5mm)
Heavy Section Steel (12mm)

Part No.	Size	Steel Thickness	Pack	Price
903 2020	5.5 x 25	5mm	100	£4.48
903 2021	5.5 x 32	5mm	100	£5.17
903 2022	5.5 x 38	5mm	100	£5.55
903 2023	5.5 x 50	5mm	100	£6.73
903 2024	5.5 x 70	5mm	100	£8.48
903 2025	5.5 x 100	5mm	100	£12.87

903 2027	5.5 x 32	12mm	100	£6.72
903 2028	5.5 x 38	12mm	100	£7.45
903 2029	5.5 x 50	12mm	100	£10.02
903 2030	5.5 x 65	12mm	100	£12.48
903 2031	5.5 x 80	12mm	100	£17.10
903 2032	5.5 x 100	12mm	100	£23.02

CSK S/DRILLING SCREW



Wing Tip Self-Drilling Screws
Light Section Steel (5mm)
Heavy Section Steel (12mm)
Countersunk Phillips Head

Part No.	Size	Steel Thickness	Pack	Price
903 2050	4.8 x 38	5mm	200	£6.12
903 2051	5.5 x 50	5mm	200	£10.37
903 2052	5.5 x 65	5mm	200	£12.25
903 2054	5.5 x 100	5mm	100	£11.42
903 2055	5.5 x 130	5mm	100	£16.17
903 2056	5.5 x 150	5mm	100	£19.25

903 2059	5.5 x 45	12mm	200	£13.28
903 2060	5.5 x 65	12mm	200	£18.97
903 2061	5.5 x 85	12mm	100	£12.92
903 2062	5.5 x 120	12mm	100	£18.32

TEC FIX STITCHING SCREW



Hexagon Head Stitching Screws
Light Section Steel to Steel
EPDM Washer, Ruspert Plated

Part No.	Size	Steel Thickness	Pack	Price
903 2080	6.3 x 22	5mm	100	£6.65
903 2081	6.3 x 25	5mm	100	£7.90

HEX S/DRILL PANEL SCREW



Hexagon Head Self-Drilling
Composite Panel Screws
Light Section Steel (5mm)
EPDM Washer

Part No.	Size	Steel Thickness	Pack	Price
903 2100	5.5 x 82	5mm	100	£14.03
903 2101	5.5 x 95	5mm	100	£16.55

GALV BONDED WASHERS



Galvanised Steel/EPDM Bonded
Washers

Part No.	Size	Pack	Price
903 2130	16mm	100	£2.65
903 2131	19mm	100	£2.65

THROUGH BOLTS



Economical & Quick to Install
Through Fixing
Zinc/Yellow Passivated

Other Sizes Available Including
Certain Sizes In Stainless Steel

Part No.	Size	Pack	Price
903 2160	M6 x 45	100	£16.20
903 2161	M6 x 70	100	£14.51
903 2162	M6 x 95	100	£20.42
903 2163	M8 x 50	100	£16.68
903 2164	M8 x 80	100	£20.56
903 2165	M8 x 100	100	£21.75
903 2166	M10 x 75	50	£12.77
903 2167	M10 x 95	50	£14.05
903 2168	M10 x 120	50	£23.85
903 2169	M12 x 80	25	£12.63
903 2170	M12 x 100	25	£12.35
903 2171	M12 x 120	25	£17.21
903 2172	M12 x 150	25	£16.50
903 2173	M16 x 105	20	£13.81
903 2174	M16 x 125	20	£19.15
903 2175	M16 x 150	15	£14.95
903 2176	M16 x 220	15	£26.57
903 2181	M20 x 160	5	£13.55
903 2178	M20 x 220	10	£22.86
903 2179	M24 x 180	10	£33.69
903 2180	M24 x 260	5	£24.80

Fasteners & Fixings

SHIELD ANCHOR - LOOSE BOLT



Traditional Expansion Anchor
4 Piece Segmented Body
Captive Expansion Cone
For Most Solid Masonry Types

Part No.	Size	Hole Size	Price (ea)
903 2200	M6 x 10	10mm	£0.40
903 2201	M6 x 25	10mm	£0.44
903 2202	M6 x 40	10mm	£0.30
903 2203	M8 x 10	14mm	£0.55
903 2204	M8 x 25	14mm	£0.74
903 2205	M8 x 40	14mm	£0.76
903 2206	M10 x 10	16mm	£0.50
903 2207	M10 x 25	16mm	£0.50
903 2208	M10 x 50	16mm	£1.12
903 2209	M10 x 75	16mm	£1.35
903 2210	M12 x 10	20mm	£1.48
903 2211	M12 x 25	20mm	£1.76
903 2212	M12 x 60	20mm	£1.84
903 2213	M16 x 15	24mm	£1.75
903 2214	M16 x 30	24mm	£1.90
903 2215	M16 x 60	24mm	£3.80

SHIELD ANCHOR - HOOK BOLT



Traditional Expansion Anchor
4 Piece Segmented Body
Captive Expansion Cone
For Most Solid Masonry Types

Part No.	Size	Hole Size	Price (ea)
903 2270	M6	10mm	£1.38
903 2271	M8	14mm	£0.98
903 2272	M10	16mm	£0.80

Shield Anchors

Also available as a loose nut - please ask for details.

SLEEVE ANCHOR - LOOSE BOLT



Sleeve Anchor with Loose Bolt
For Most Solid Masonry Types
Zinc/Yellow Passivated

Part No.	Size	Pack	Price
903 2300	M8 x 45	100	£11.98
903 2301	M8 x 70	50	£13.59
903 2302	M8 x 90	50	£14.01
903 2303	M10 x 45	50	£14.10
903 2304	M10 x 55	50	£16.11
903 2305	M10 x 80	50	£21.91
903 2306	M10 x 100	50	£21.63
903 2307	M12 x 65	50	£18.65
903 2308	M12 x 80	50	£26.78
903 2309	M12 x 100	25	£17.45
903 2310	M16 x 75	25	£23.71
903 2311	M16 x 120	10	£14.58

Sleeve Anchors

Also available as a loose nut - please ask for details.

WIRE HANGERS



For Fixing Suspended Ceilings
Zinc/Yellow Passivated

Part No.	Size	Pack	Price
903 2330	M6 x 60	100	£10.45

SHIELD ANCHOR ONLY



Traditional Expansion Anchor
4 Piece Segmented Body
Captive Expansion Cone
For Most Solid Masonry Types

Part No.	Size	Hole Size	Price (ea)
903 2230	M6	10mm	£0.31
903 2231	M8	14mm	£0.42
903 2232	M10	16mm	£0.62
903 2233	M12	20mm	£0.84
903 2234	M16	24mm	£2.00

SHIELD ANCHOR - EYE BOLT



Traditional Expansion Anchor
4 Piece Segmented Body
Captive Expansion Cone
For Most Solid Masonry Types

Part No.	Size	Hole Size	Price (ea)
903 2250	M6	10mm	£0.55
903 2251	M8	14mm	£1.24
903 2252	M10	16mm	£1.13
903 2253	M12	20mm	£2.26

Fasteners & Fixings

HOOK & EYE BOLTS



Hook & Eye Bolts
Zinc and Yellow Passivated for
Improved Corrosion Resistance

Part No.	Size	Type	Price (ea)
903 2360	M6	Eye	£0.58
903 2361	M8	Eye	£0.66
903 2362	M10	Eye	£0.98
903 2364	M12	Eye	£1.62
903 2365	M6	Hook	£0.42
903 2366	M8	Hook	£0.56
903 2367	M10	Hook	£0.90
903 2368	M12	Hook	£1.44

RUBBER ANCHOR NUTS



For Fixing in Almost Any Type of
Construction Material
Fixing Expands to Fit Internal
Profile of Cavity

Part No.	Size	Price (ea)
903 2390	M4 x 11	£0.25
903 2391	M4 x 25	£0.30
903 2392	M5 x 15	£0.28
903 2393	M5 x 25	£0.50
903 2394	M5 x 40	£0.35
903 2395	M6 x 15	£0.48
903 2396	M6 x 25	£0.85
903 2397	M8 x 25	£1.00
903 2398	M8 x 50	£1.08
903 2399	M10 x 55	£1.50
903 2400	M12 x 75	£1.60

SHEAR NUTS



Shear Nuts
Permanent Security Fastening
Zinc Plated

Part No.	Size	Price (ea)
903 2430	M8	£0.24
903 2431	M10	£0.30
903 2432	M12	£0.60

STUDDING CONNECTORS



Studding Connectors
Bright Zinc Plated

(also available in Stainless Steel)

Part No.	Size	Price (ea)
903 2460	M6 x 18	£0.14
903 2461	M8 x 24	£0.15
903 2462	M10 x 30	£0.30
903 2463	M12 x 36	£0.45
903 2464	M16 x 48	£0.80
903 2465	M20 x 60	£1.40
903 2466	M24 x 72	£2.60

MULTI-FIX POLYESTER RESIN



Multi-Fix Polyester 2 Part
Chemical Anchoring System
For Use in All Masonry Types

410 ml Tube

Part No.	Size	Price
903 2500	Multi Fix Resin 410ml	£8.63
903 2501	Multi Fix Resin Gun	£16.22
903 2502	Mixer Nozzle Only	£0.95

BLOW OUT PUMP



Air Blow Pump 280ml
Ideal for Clearing Dust from
Drilled Holes

Part No.	Price
903 2515	£8.38

CHEMICAL ANCHOR STUDS



Supplied with Nut & Washer
Zinc Galvanised

(also available in Stainless Steel)

Part No.	Size	Price (ea)
903 2530	M8 x 110	£0.35
903 2531	M10 x 130	£0.50
903 2532	M12 x 160	£0.92
903 2533	M16 x 190	£1.53
903 2534	M20 x 270	£2.90

Assorted Boxes

SETSCREWS M6-M12



Metric HT Setscrews
Grade 8.8. Zinc Passivated
Quantity: 150

Sizes: M6 x 40, M8 x 25, M8 x 40,
M8 x 50, M10 x 40, M12 x 50mm

Part No.	Price
105 219	£13.27

UNF SETSCREWS



UNF HT Setscrews - Zinc Plated
Quantity: 150

Sizes: 3/16" x 1", 1/4" x 3/4", 1/4" x 1",
1/4" x 1 1/2", 5/16" x 3/4", 5/16"
x 1", 5/16" x 1 1/2", 3/8" UNF x 1"

Part No.	Price
105 114	£12.93

M6 FASTENERS



Assorted M6 Setscrews & Steel
Nuts Grade 8.8. Zinc Passivated
Quantity: 295

Sizes: M6 x 16, M6 x 20, M6 x 25,
M6 x 40, M6 x 50mm

Part No.	Price
105 192	£10.23

UNC SETSCREWS



UNC HT Setscrews
Grades S, Zinc Plated
Quantity: 105

Sizes: 1/4" x 1", 1/4" x 1 1/2", 1/4"
x 2", 5/16" x 1", 5/16" x 1 1/2", 3/8"
UNC x 1"

Part No.	Price
105 117	£12.08

M8 FASTENERS



Assorted M8 Setscrews & Steel
Nuts
Grade 8.8. Zinc Passivated
Quantity: 154

Sizes: M8 x 16, M8 x 25, M8 x 40,
M8 x 50, M8 x 60mm

Part No.	Price
105 193	£10.95

SOCKET CAP SCREWS



Socket Cap Head Screws
Chemical Black
Quantity: 120

Sizes: M5 x 10, M5 x 25, M6 x 25,
M8 x 25, M8 x 30, M10 x 25, M10
x 30mm

Part No.	Price
105 216	£13.88

M10 FASTENERS



Assorted M10 Setscrews & Steel
Nuts
Grade 8.8. Zinc Passivated
Quantity: 88

Sizes: M10 x 25, M10 x 30, M10 x 40,
M10 x 50mm

Part No.	Price
105 194	£11.10

SOCKET SET (GRUB) SCREWS



Socket Set (Grub) Screws
Chemical Black
Quantity: 220

Sizes: M4 x 8, M5 x 5, M5 x 8, M5 x 10,
M6 x 6, M6 x 8, M6 x 10, M8 x 8,
M8 x 10, M8 x 12, M10 x 12mm

Part No.	Price
105 215	£14.03

STAINLESS STEEL FASTENERS



Stainless Steel Setscrews, Nuts &
Flat Washers
Quantity: 270

Sizes: M5 x 20, M6 x 20, M6 x 30,
M8 x 40, M10 x 40mm

Part No.	Price
105 179	£27.52

STEEL BA SCREWS



Steel BA Screws & Nuts Round
Head
Zinc Plated
Quantity: 300 Pairs

Sizes: 6BA x 1", 4BA x 1", 2BA x 1",
2BA x 2"

Part No.	Price
105 111	£16.24

Assorted Boxes

BRASS BA SCREW SETS



Brass BA Screws, Nuts & Washers
Countersunk, Cheese & Round
Head
Quantity: 315 Sets

Sizes: 6BA x 1", 5BA x 1", 4BA x 1",
3BA x 1", 2BA x 1".

Part No.	Price
105 212	£102.30

UNF STEEL NUTS



UNF Steel Nuts
Zinc Plated
Quantity: 300

Sizes: 3/16", 1/4", 5/16", 3/8" UNF

Part No.	Price
105 115	£11.48

STEEL MACHINE SCREWS



Steel Machine Screws & Nuts
Pan Head, Zinc Passivated
Quantity: 300 Pairs

Sizes: M3 x 6, M3 x 20, M4 x 8, M4
x 16 M4 x 25, M5 x 12, M5 x 16, M5
x 25mm

Part No.	Price
105 122	£11.65

METRIC NYLOC NUTS



Metric Nylon Insert Locking Nuts
Zinc Plated
Quantity: 220

Sizes: M5, M6, M8, M10, M12,
M14, M16

Part No.	Price
105 121	£11.47

BRASS MACHINE SCREW SETS



Brass Machine Screws, Nuts &
Washers Countersunk, Cheese &
Round Head
Quantity: 315

Sizes: M3 x 25, M3.5 x 25, M4 x 25,
M5 x 25mm

Part No.	Price
105 223	£71.36

UNF NYLOC NUTS



UNF Nylon Insert Locking Nuts
Zinc Plated
Quantity: 220

Sizes: 1/4", 5/16", 3/8", 7/16", 1/2"
UNF

Part No.	Price
105 116	£12.37

METRIC STEEL NUTS



Assorted Metric Steel Nuts
Zinc Passivated
Quantity: 370

Sizes: M6, M8, M10, M12

Part No.	Price
105 220	£10.23

UNC NYLOC NUTS



UNC Nylon Insert Locking Nuts
Zinc Plated
Quantity: 300

Sizes: 1/4", 5/16", 3/8" UNC

Part No.	Price
105 118	£15.75

METRIC FINE STEEL NUTS



Assorted Metric Fine Steel Nuts
Zinc Passivated
Quantity: 370

Sizes: M5 (0.50), M6 (0.75), M8
(1.00), M10 (1.25 Pitch)

Part No.	Price
105 199	£17.92

METRIC FLANGED NUTS



Metric Serrated Flange Nuts
Zinc Plated
Quantity: 225

Sizes: M5, M6, M8, M10, M12

Part No.	Price
105 195	£10.53

Assorted Boxes

FORM A FLAT WASHERS



Form A Flat Washers
Zinc Passivated
Quantity: 800

i.d. Sizes: 5, 6, 8, 10, 12, 16mm

Part No.	Price
105 125	£11.62

LOCK WASHERS



Internal & External Lock Washers
Quantity: 1000

i.d. Sizes: 3/16", 1/4", 5/16", 3/8",
7/16", 1/2"

Part No.	Price
105 129	£17.95

TABLE 3 FLAT WASHERS



Table 3 Flat Washers
Zinc Plated
Quantity: 800

i.d. Sizes: 3/16", 1/4", 5/16", 3/8",
7/16", 1/2"

Part No.	Price
105 126	£12.73

FIBRE WASHERS



Fibre Washers
Quantity: 610

Sizes: 13/64" x 3/8", 1/4" x 3/8",
3/8" x 5/8", 13/32" x 5/8", 29/64"
x 11/16", 1/2" x 3/4", 5/8" x 7/8",
49/64" x 15/16"

Part No.	Price
105 131	£21.53

REPAIR WASHERS



Repair Washers, Zinc Plated
Quantity: 230

Sizes: 3/16" x 1", 3/16" x 1 1/2", 1/4"
x 1, 1/4" x 1 1/2", 5/16" x 1", 5/16" x
1 1/2", 3/8" x 1 1/2", 3/8" x 2"

Part No.	Price
105 130	£12.90

COPPER WASHERS - SMALL



Metric Copper Washers - Small
Quantity: 244, Sizes: 5 x 9, 6 x 10,
6.5 x 9.5, 8 x 12, 9 x 14, 14 x 18 (x
1mm). 10 x 16, 11 x 17, 12 x 16, 13
x 18, 14 x 20, 16 x 22, 16 x 24, 17
x 23 (x1.5mm). 15 x 20, 17.5 x 25
(x 2mm)

Part No.	Price
105 152	£19.93

METRIC SPRING WASHERS



Metric Spring Washers
Zinc Passivated
Quantity: 800

i.d. Sizes: M5, M6, M8, M10, M12,
M16

Part No.	Price
105 128	£9.82

COPPER WASHERS - LARGE



Metric Copper Washers - Large
Sizes
Quantity: 90
Sizes: 18 x 24, 20 x 24, 22 x 27
(x 1.5mm). 24 x 30, 26 x 34, 28
x 34, 30 x 38, 32 x 40, 35 x 45 (x
2mm)

Part No.	Price
105 153	£25.94

IMPERIAL SPRING WASHERS



Imperial Spring Washers
Zinc Passivated
Quantity: 800

i.d. Sizes: 3/16", 1/4", 5/16", 3/8",
7/16", 1/2"

Part No.	Price
105 127	£13.87

COPPER WASHERS - IMPERIAL

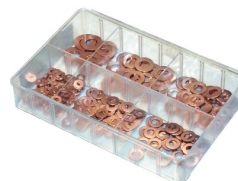

Imperial Copper Washers
Quantity: 300

Sizes: 3/16" x 7/16", 1/4" x 9/16" (x
20g). 5/16" x 5/8", 3/8" x 3/4", 7/16"
x 7/8" (x 18g). 1/2" x 1" (x 16g)

Part No.	Price
105 132	£32.50

Assorted Boxes

COPPER SEALING WASHERS



BSP & Imp. Copper Sealing Washers
Quantity: 225
BSP Sizes: 1/8 (x2 Types), 1/4 (x2 Types), 3/8, 1/2 (x2 Types), 5/8, 3/4, 7/8, 1 BSP Imperial Sizes: 1/4" (x 3 Types), 5/16" (x 2 Types)

Part No.	Price
105 133	£32.43

BSP DOWTY WASHERS



BSP Bonded Seals (Dowty Washers)
Quantity: 100
Sizes: 1/8", 1/4", 3/8", 1/2", 5/8", 3/4", 1" BSP

Part No.	Price
105 143	£18.55

COMPRESSION WASHERS

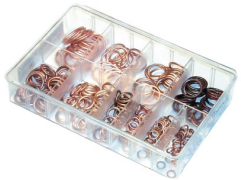

Copper Compression Washers
Quantity: 250
Sizes: 6 x 10 x 1.5, 8 x 12 x 1.5, 10 x 14 x 1.5, 12 x 18 x 2, 14 x 20 x 2, 16 x 22 x 2, 18 x 24 x 2, 20 x 26 x 2, 22 x 27 x 2, 26 x 32 x 2.5mm

Part No.	Price
105 147	£38.12

ASSORTED CIRCLIPS



Assorted Internal & External Circlips
Quantity: 280
Sizes: 12, 13, 14, 16, 18, 22, 24, 25mm

Part No.	Price
105 141	£13.12

FUEL INJECTION WASHERS



Copper Fuel Injection Washers
Quantity: 360
6 x 10, 6 x 12, 8 x 11.5, 10 x 13.5, 10 x 14 (x 1mm) 12 x 16, 12 x 18, 14 x 18, 16 x 20, 17 x 21 (1.5mm)

Part No.	Price
105 189	£19.08

ASSORTED E-CLIPS



E Retaining Clips
Quantity: 800
Sizes: 1.5, 2.3, 3.2, 4, 5, 6, 8, 10, 12, 15mm

Part No.	Price
105 142	£11.00

SUMP PLUG WASHERS



Sump Plug Washers - Various Types
Quantity: 250
Suitable For: BMW, Ford, Vauxhall, VW, Peugeot, Citroen, Renault, Honda, Rover, & Volvo

Part No.	Price
105 187	£33.57

SPEED FASTENERS

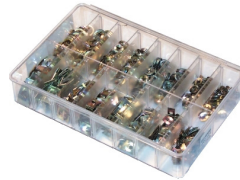

Round & Rectangular Flat Clips
Zinc Passivated
Quantity: 1000
Metric Sizes: 3, 4, 5, 8mm

Part No.	Price
105 108	£50.90

METRIC DOWTY WASHERS



Metric Bonded Seals (Dowty Washers)
Quantity: 90
Sizes: M10, M14, M16, M18, M20, M22, M24

Part No.	Price
105 218	£18.83

'J' & 'U' NUTS

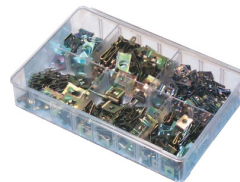

Assorted Box of 'U' & 'J' Nuts
Zinc Passivated
Quantity: 300
'U' Nut Sizes No. 6 to 14
'J' Nut Size No. 14

Part No.	Price
105 109	£30.47

Assorted Boxes

METRIC O-RING SET



Metric Rubber 'O' Rings Yellow Box Set - Quantity: 404
i.d. x Thickness (in mm): 3, 4, 5, 6, 7, 8, 10 (x 2), 10, 11, 12, 13, 14, 16, 17, 19 (x 2.5), 19, 20, 22, 24, 25, 27, 28, 30, 32, 33, 35, 36, 38 (x 3), 38, 41, 44 (x 4)

Part No.	Price
105 171	£17.87

SELF TAPPERS - SLOTTED/PAN



Self Tapping Screws, Slotted Pan Head
Zinc Plated, Quantity: 330
Sizes: 8 x 1 1/2", 10 x 1/2", 10 x 3/4", 10 x 1", 10 x 1 1/2", 12 x 3/4", 12 x 1", 12 x 1 1/2"

Part No.	Price
105 103	£11.33

IMPERIAL O-RING SET



Quantity: 382
i.d. x Thickness (in mm): 2.9, 3.68, 4.48, 5.28, 6.07, 7.66, 9.25 (x 1.78), 9.19, 10.78, 12.31, 13.95, 15.54, 17.13, 18.72 (x 2.62), 18.64, 20.22, 21.82, 23.40, 24.99, 26.58, 28.17, 29.75, 31.34, 32.92, 34.52, 36.10, 37.69 (x 3.53), 37.47, 40.65, 43.82

Part No.	Price
105 158	£14.80

SELF TAPPERS - PZD/CSK HEAD



Self Tapping Screws - Pozidriv, Countersunk Head, Zinc Plated
Quantity: 615

Sizes: 6 x 1/2", 6 x 3/4", 6 x 1", 8 x 1/2", 8x3/4", 8 x 1", 10 x 1/2", 10 x 3/4", 10x1"

Part No.	Price
105 107	£11.95

SELF TAPPERS - PZD/PAN HEAD



Self Tapping Screws - PZD Pan Head
Zinc Plated, Quantity: 700

Sizes: 4 x 1/2", 6 x 1/2", 6 x 3/4", 8 x 1/2", 8 x 3/4", 8 x 1", 8 x 1 1/2", 10 x 1/2", 10 x 3/4", 10 x 1"

Part No.	Price
105 102	£9.96

SELF TAPPERS - FLANGE HEAD



Self Tapping Screws - PZD Flange Head
Chemical Black, Quantity: 700
Flange Head Sizes: 6 x 1/2", 6 x 3/4", 8 x 3/4", 8 x 1/2", 10 x 1/2", 10 x 3/4" Plus 8 x 1 1/2" Countersunk Head

Part No.	Price
105 105	£14.40

SELF TAPPERS - PZD/PAN HEAD



Self Tapping Screws - PZD Pan Head
Zinc Plated, Quantity: 330

Sizes: 8 x 1 1/2", 10 x 1/2", 10 x 3/4", 10 x 1", 10 x 1 1/2", 12 x 3/4", 12 x 1", 12 x 1 1/2"

Part No.	Price
105 104	£10.15

WOOD SCREWS



Wood Screws - PZD Countersunk Head
Zinc Plated, Quantity: 525

Sizes: 4x1/2", 6 x 5/8", 6 x 1", 6 x 1 1/2", 8 x 1", 8 x 1 1/2", 8 x 2", 10 x 1 1/2", 10 x 2", 12 x 2"

Part No.	Price
105 139	£10.98

SELF TAPPERS - SLOTTED/PAN



Self Tapping Screws, Slotted Pan Head
Zinc Plated, Quantity: 700

Sizes: 4 x 1/2", 6 x 1/2", 6 x 3/4", 8 x 1/2", 8 x 3/4", 8 x 1", 8 x 1 1/2", 10 x 1/2", 10 x 3/4", 10 x 1"

Part No.	Price
105 101	£10.70

'SOLO' SCREWS



Classic 'Solo' Screws - PZD Countersunk Head, Zinc Passivated,
Quantity: 355

Sizes: 3 x 12mm, 3 x 25mm, 3 x 30mm, 4 x 25mm, 4 x 40mm, 4 x 60mm, 5 x 35mm, 5 x 60mm, 6 x 40mm, 6 x 60mm

Part No.	Price
105 138	£10.30

Assorted Boxes

'ACME' SCREWS



'Acme' Sheet Metal Screws With Captive Washer - Hexagon Head
Quantity: 255

Sizes: 8 x 3/4", 10 x 1/2", 10 x 3/4", 12 x 1/2", 12 x 3/4", 14 x 3/4"

Part No.	Price
105 106	£26.67

METRIC SPRING ROLL PINS



Metric Spring Roll Pins
Quantity: 300

Sizes: 2.5 x 24, 2.5 x 40, 3 x 40, 4 x 40, 5 x 40, 6 x 40, 8 x 24, 8 x 55mm

Part No.	Price
105 136	£17.58

NUMBER PLATE FIXINGS



Assorted Number Plate Fixings
Quantity: 240 Sets

Contains Cap, Dome & Screws & Nylon Nuts & Bolts. In White, Yellow & Black

Part No.	Price
105 110	£15.06

IMPERIAL SPRING ROLL PINS



Imperial Spring Roll Pins
Quantity: 385

Sizes: 3/32" x 1", 1/8" x 1 1/2", 5/32" x 3/4", 5/32" x 2", 3/16" x 1", 3/16" x 2", 1/4" x 1", 1/4" x 2", 5/16" x 1", 5/16" x 2"

Part No.	Price
105 185	£22.61

SPLIT PINS - SMALL SIZES



Imperial Split Cotter Pins - Small Sizes Zinc Plated, Quantity: 1000

Sizes: 1/16" x 1", 5/64" x 1", 3/32" x 1 1/2", 7/64" x 1 1/2", 1/8" x 1 1/2", 9/64" x 1 1/2", 5/32" x 1 5/8"

Part No.	Price
105 134	£22.65

WOODRUFF KEYS



Steel Woodruff Keys, Quantity: 220

Sizes: 2 x 3.7, 2.5 x 3.7, 3 x 3.7, 3 x 5, 3 x 6.5, 4 x 5, 4 x 6.5, 4 x 7.5, 4 x 9, 5 x 6.5, 5 x 9, 6 x 9, 6 x 11, 6 x 13, 6 x 15, 8 x 11, 8 x 13, 10 x 13mm

Part No.	Price
105 157	£49.92

SPLIT PINS - LARGE SIZES



Imperial Split Cotter Pins - Large Sizes Zinc Plated, Quantity: 220

Sizes: 1/8" x 1 1/2", 1/8" x 2 1/4", 9/64" x 1 1/2", 5/32" x 1 5/8", 3/16" x 3", 1/4" x 3", 5/16" x 3"

Part No.	Price
105 137	£17.52

POP RIVETS & WASHERS



Assorted Box of POP Open Type Rivets Aluminium, Quantity: 350
Standard Flange Sizes: 1/8" x 3/8", 1/8" x 1/2", 5/32" x 1/2", 3/16" x 1/2", 3/16" x 3/4". Large Flange Sizes: 3/16" x 1/2", 3/16" x 3/4", 3/16" x 1"

Part No.	Price
105 188	£11.66

CLEVIS PINS



Assorted Clevis Pins, Zinc Plated
Quantity: 175

Sizes: 3/16" x 5/8", 3/16" x 7/8", 1/4" x 5/8", 1/4" x 11/16", 5/16" x 7/8", 5/16" x 1" 3/8" x 1 1/4". 6 x 20mm

Part No.	Price
105 135	£54.47

AVEX RIVETS & WASHERS



AVEX Rivets - Large & Standard Flange Zinc Plated Steel, Quantity: 500
Standard Flange Sizes: 1/8" x 3/8", 1/8" x 1/2", 5/32" x 7/16", 3/16" x 1/2", 3/6" x 3/4", 3/16" x 1". Large Flange Sizes: 3/16" x 3/4", 3/16" x 1"

Part No.	Price
105 166	£11.10

Assorted Boxes

INTERIOR TRIM CLIPS



Interior Trim Clips - Nylon. Black & Natural Quantity: 280

Types: Canoe Clips, Trim Pad Clips, Lokut Nuts, Fir Tree Fixes, Rokut Rivets, Screw Type Push Rivets

Part No.	Price
105 197	£30.17

TYRE VALVES & CORES



Tyre Valves, Cores & Accessories Quantity: 115

Contains: Metal, Plastic Extensions. Short, Long Cores. Short, Long Tubeless Valves. Valve Tool. Key Clip. Plastic Caps

Part No.	Price
105 183	£34.18

BODY & TRIM CLIPS



Body Clips & Trim Fixings - Nylon/ Metal Quantity: 310

Various Types Including: Trim Pad Clips, Rivet Pipe Clips, Metal Edge Clips, Buttons, Rivets

Part No.	Price
105 191	£35.67

PUNCTURE REPAIR KIT



Puncture Repair Kit Quantity: 33 Pieces

Contains Vulcanising Fluid (Cement), Waterproof Crayon Marker & Patches Patch Diameter Sizes: 45, 55, 60, 80mm

Part No.	Price
105 178	£20.72

BRAKE TUBE NUTS



Male & Female Brake Nuts Zinc Plated, Quantity: 135

Male: 10 x 1mm (Short, Fully Threaded Short, Long), 3/8" UNF x 24 tpi. Female: 10 x 1mm, 3/8" UNF x 24 tpi

Part No.	Price
105 145	£24.23

ASSORTED SPRINGS



Expansion & Compression Springs Quantity: 250

Expansion (o.d. x length): 3.2 x 22, 4.78 x 25.4, 6.5 x 32, 6.35 x 29, 7.92 x 35, 7.92 x 45, 9.5 x 35mm Compression (o.d. x length): 3.05 x 14.5, 4.57 x 13, 6.1 x 22, 6.1 x 25, 7.62 x 31.75, 10.6 x 25mm

Part No.	Price
105 146	£31.90

BRAKE SHOE HOLD DOWN KITS



Brake Shoe Hold Down Kits Zinc Plated, Quantity: 200 Pieces

Pins Suitable For: Ford, Peugeot, Fiat Springs Suit: Ford, GM/Vauxhall, Renault Washer Types: Lockheed, Girling

Part No.	Price
105 222	£39.79

COPPER CABLE LUGS



Copper Tube Terminals (Cable Lugs) Quantity: 80

Sizes: 10 x 8mm², 16 x 8mm², 25 x 6mm², 25 x 8mm², 25 x 10mm², 35 x 8mm², 35 x 10mm², 35 x 12mm², 50 x 10mm², 50 x 12mm², 70 x 10mm², 70 x 12mm²

Part No.	Price
105 227	£35.50

MANIFOLD STUDS & NUTS



Exhaust Manifold Studs & Nuts Quantity: 80

Stud Sizes: M10 x 52, M8 x 37mm. M10 (Fine) x 37mm. 3/8" (UNF, UNC). 5/16" (UNF/UNC, UNF, UNC) Brass Nut Sizes: M8. M10 (Fine). 3/8" (UNF, UNC). 5/16" (UNF/UNC) Copper Flashed Nut Sizes: M10

Part No.	Price
105 217	£25.08

TOGGLE SWITCHES



Toggle Switches, Illuminated Toggle Switches, Illuminated Rocker Switches & Warning Lights 12 volts, 20 amps

Quantity: 20

Part No.	Price
105 154	£18.90

Assorted Boxes

BLADE FUSES



Standard Blade Fuses
(19mm across the top)
Quantity: 80

Sizes: 2, 3, 4, 5, 7.5, 10, 15, 20, 25 & 30 amp

Part No.	Price
105 163	£8.70

RING & FORK TERMINALS



Red, Blue & Yellow Ring & Fork
Pre-Insulated Terminals,
Quantity: 200

Sizes: 3.7 (Red, Blue), 5.3mm (Red, Blue)
Forks. 3.2 (Red, Blue) 3.7 (Red, Blue) 5.3 (Red,
Blue, Yellow) 6.4 (Red, Blue), 8.4 (Blue, Yellow)
10.5mm (Yellow) Rings

Part No.	Price
105 164	£11.04

MINI BLADE FUSES



Mini Blade Fuses
(10mm across the top)
Quantity: 100

Sizes: 2, 3, 4, 5, 7.5, 10, 15, 20, 25 & 30 amp

Part No.	Price
105 190	£14.50

PUSH ON TERMINALS



Red, Blue & Yellow Push On
Terminals Quantity: 200

Sizes: 2.8, 4.8, 6.3, 9.0mm
Colours: Red, Blue, Yellow
Types: Male Piggy-backs, Fully Insulated
Female Spades, Male Blades, Bullets,
Receptacle Sockets, Butt Connectors

Part No.	Price
105 165	£11.61

CONTINENTAL FUSES



Continental, Ceramic Fuses
(Torpedo Fuses)
Quantity: 200

Sizes: 5, 8, 16, 25 amp

Part No.	Price
105 162	£30.93

ASSORTED TERMINALS



Large Assorted Box of Ring, Fork &
Push On Terminals &
Connectors
655 Pieces

Part No.	Price
105 303	£43.95

GLASS AUTO FUSES

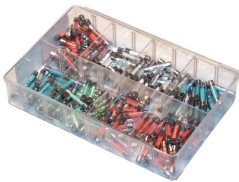

Glass Auto Fuses
Quantity: 185

Sizes: 2, 5, 10, 15, 25, 35, 50 amp

Part No.	Price
105 161	£12.93

HEAT SHRINK TUBING - 200MM



Heat Shrink Tubing - 200mm
Lengths Quantity: 30

Diameters: 4.8, 6.4, 9.5mm (Black,
Blue, Red, Yellow), 12.7mm (Black,
Red, Yellow)

Part No.	Price
105 181	£8.44

AUTO & DOMESTIC FUSES



Large Assorted Box of Auto &
Domestic Fuses

324 Pieces

Part No.	Price
105 304	£52.12

HEAT SHRINK TUBING - 50/70MM



Heat Shrink Tubing - 50 & 70mm
Lengths Quantity: 160

Diameter x Length: 3.2 x 50, 4.8 x
50, 12.7 x 70mm (Black, Blue, Red,
Yellow)

Part No.	Price
105 186	£10.65

Assorted Boxes

RUBBER GROMMETS



Rubber Wiring & Blanking
Grommets Quantity: 120

Blank Sizes: 8, 9.5, 12.5, 16.3, 19,
25.4mm Wiring (Cable) Sizes: 6.4 x
4.75, 9.5 x 6.4, 9.5 x 8, 12.5 x 9.5,
12.5 x 11, 16 x 12.5mm

Part No.	Price
105 144	£20.45

IMP. SPEEDFIT COUPLINGS



Imperial Speedfit Couplings
Equal Tees & Elbows
Quantity: 26

Sizes: 5/32", 3/16", 1/4", 5/16", 3/8",
1/2"

Part No.	Price
105 149	£60.09

O-CLIPS



Assorted O-Clips, Zinc Plated
Quantity: 125

Sizes: 3/8" (8 - 11mm), 7/16" (9 -
11mm), 1/2" (11 - 13mm), 9/16" (13 -
15mm), 5/8" (15 - 18mm), 3/4" (17 -
20mm), 7/8" (20 - 23mm)

Part No.	Price
105 159	£21.88

METRIC SPEEDFIT COUPLINGS



Metric Speedfit Couplings
Equal Straights
Quantity: 24

Sizes: 4, 5, 6, 8, 10, 12mm

Part No.	Price
105 173	£44.69

PIPE REPAIR KIT



Pipe Repair Kit - O-Clips & Pipe
Joiners Zinc Plated
Quantity: 72

Joiner Sizes: 1/4", 5/16", 3/8", 1/2",
5/8" 'O' Clip Sizes: 1/2", 9/16", 5/8",
3/4", 7/8"

Part No.	Price
105 168	£29.73

METRIC SPEEDFIT COUPLINGS



Metric Speedfit Couplings
Equal Tees & Elbows
Quantity: 26

Sizes: 4, 6, 8, 10, 12mm

Part No.	Price
105 150	£63.61

MINI HOSE CLIPS



Mini Hose Clips, Zinc Plated
Quantity: 80

Sizes: 7 - 9, 9 - 11, 11 - 13, 12 - 14,
13 - 15, 15 - 17mm

Part No.	Price
105 184	£20.48

IMPERIAL BRASS COUPLINGS



Imperial Brass Tube Couplings
Equal Straights
Quantity: 25 Sets

Sizes: 3/16", 1/4", 5/16", 3/8", 1/2"

Part No.	Price
105 270	£99.70

IMP. SPEEDFIT COUPLINGS



Imperial Speedfit Couplings
Equal Straights
Quantity: 24

Sizes: 5/32", 3/16", 1/4", 5/16", 3/8",
1/2"

Part No.	Price
105 172	£41.34

METRIC BRASS COUPLINGS



Metric Brass Tube Couplings
With Stepped Olives
Quantity: 25 Sets

Sizes: 4, 5, 6, 8, 10, 12mm

Part No.	Price
105 269	£87.00

Assorted Boxes & Packs

IMPERIAL GREASE NIPPLES



Imperial Grease Nipples - Angled & Straight. Zinc Plated, Quantity: 120

BSP Sizes: 1/8 (Hex, Straight, 45°, 90°). 1/4 (Straight)
UNF Sizes: 1/4" (Straight, 45°, 90°), 1/4" Long (Straight)

Part No.	Price
105 255	£33.15

METRIC FASTENERS



Assorted Pack of Metric Fasteners HT Setscrews, HT Bolts & Steel Nuts Quantity: 60 Sets

Setscrew Sizes: M6x50, M8x50, M10x50 Bolt Sizes: M12x50, M12x75, M16x50mm

Part No.	Price
110 135	£16.16

METRIC GREASE NIPPLES



Metric Grease Nipples - Angled & Straight. Zinc Plated, Quantity: 135

Sizes: M6 x 1 (Straight, 90°) M8 x 1 (Straight), M8 x 1.25 (Straight, 45°, 90°), M10 x 1mm (Straight, 90°)

Part No.	Price
105 256	£31.52

STEEL BA SCREWS & NUTS



Assorted Pack of Steel BA Screws & Nuts Various Head Types Quantity: 200 Pairs

Sizes: 2BA x 1/2", 1" & 1.1/2"

Part No.	Price
110 123	£17.38

ASSORTED PLASTERS



Stretch Fabric & Waterproof Adhesive Plasters, Individually Wrapped Quantity: 120

Sizes: 7 x 2.4mm, 7 x 3.8mm

Part No.	Price
105 260	£13.36

BRASS BA SCREWS & NUTS



Assorted Pack of Brass BA Screws & Nuts Various Head Types Quantity: 200 Pairs

Sizes: 2BA x 1/2", 1" & 1.1/2"

Part No.	Price
110 124	£59.27

CLEAR BOX WITH DIVIDERS



Clear Empty Standard Box Complete with 8 Dividers & Removable Flip-Top Lid

Part No.	Price
105 175	£2.49

METRIC THREADED BAR



Assorted Pack of Metric Threaded Bar 30cm Lengths, Zinc Passivated Quantity: 30

Sizes: M6, M8, M10, M12

Part No.	Price
110 108	£19.07

DISPLAY RACK



Display Rack For Box Assortments Holds Up To 10 Standard Boxes Free Standing Or Wall Mounted

(boxes not included)

Part No.	Price
105 201	£34.95

UNF THREADED BAR



Assorted Pack of UNF Threaded Bar 12" Lengths, Zinc Plated Quantity: 30

Sizes: 1/4", 5/16", 3/8"

Part No.	Price
110 106	NLA

Assorted Packs

FARMERS PACK



Assorted Nuts, Screws, Bolts, Washers, Rivets, etc.

(Contents May Vary)

Part No.	Price
110 129	£6.78

HEAVY DUTY WASHERS



Assorted Pack of Table 4 Flat Washers Large O/D, Zinc Plated
Quantity: 50

Sizes: 1/2", 5/8", 3/4", 7/8", 1", 1 1/4", 1 1/2"

Part No.	Price
110 151	£14.47

KEY STEEL - IMPERIAL SIZES

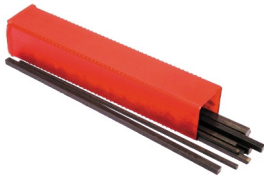

Key Steel Imperial Sizes - 12"
Lengths Zinc Plated, Quantity: 20

Sizes: 3/16" x 3/16", 1/4" x 3/16",
1/4" x 1/4", 5/16" x 1/4", 5/16" x
5/16", 3/8" x 1/4", 3/8" x 3/8", 1/2"
x 5/16"

Part No.	Price
110 105	£62.41

SHAKEPROOF WASHERS



Imperial External Shakeproof
Washer, ID: 5/16"
Quantity: 50

Part No.	Price
903 1111	£1.90

FLAT STEEL BAR



Flat, Mild Steel Bar
Zinc Plated, Quantity: 10

Sizes (Width x Thickness): 20 x 3,
20 x 5, 25 x 3, 25 x 5, 25 x 6, 40 x
3, 40 x 5, 40 x 6mm

Part No.	Price
110 110	£64.10

MINI COMPRESSION SPRINGS



Mini Compression Springs
Zinc Plated
Quantity: 50

Various Small Lengths & Widths

Part No.	Price
110 141	£7.27

ROUND STEEL BAR

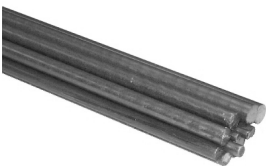

Round, Mild Steel Bar
Zinc Plated, Quantity: 10

Diameter Sizes: 3/16", 1/4", 5/16",
3/8", 7/16", 1/2"

Part No.	Price
110 111	£45.02

COMPRESSION SPRINGS

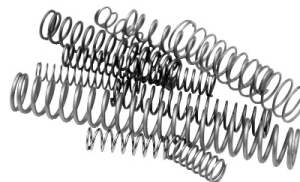

Large Compression Springs
Zinc Plated
Quantity: 70

Various Large Lengths & Widths

Part No.	Price
110 113	£8.71

ANGLE IRON

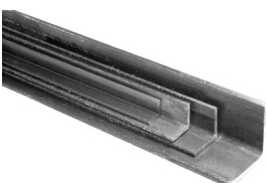

Angle Iron, Mild Steel
Quantity: 5 Pieces

Sizes: (Height x Width x Thick-
ness): 20 x 20 x 3mm, 30 x 30 x
3mm, 40 x 40 x 3mm

Part No.	Price
110 125	£42.18

MINI EXPANSION SPRINGS



Mini Expansion Springs
Zinc Plated
Quantity: 50

Various Small Lengths & Widths

Part No.	Price
110 142	£9.04

Assorted Packs

EXPANSION SPRINGS



Large Expansion Springs
Zinc Plated
Quantity: 70

Various Large Lengths & Widths

Part No.	Price
110 112	£11.40

TOUCH UP BRUSHES



Assorted Pack of General Use
Touch-Up Paint Brushes -
Plastic Handles

24 Brushes in 3 Sizes

Part No.	Price
110 173	£5.43

ACCEL'TOR & CLUTCH SPRINGS

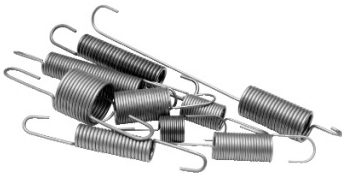

Accelerator & Clutch Springs
Zinc Plated
Quantity: 36

Various Lengths & Widths

Part No.	Price
110 159	£9.88

TOUCH UP BRUSHES



High Quality Touch-Up Paint
Brushes Wooden Handles

10 Brushes
Sizes: No. 2, 4, 6, 8

Part No.	Price
110 114	£8.51

R GRIPS

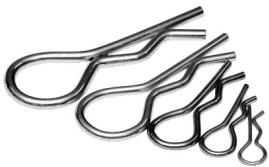

R-Grips Assorted Pack, Zinc Plated
Quantity: 50

Diameter x Working Length: 2mm x 10mm
(5/64" x 3/8"), 3mm x 19mm (1/8" x 3/4"),
4mm x 25mm (5/32" x 1"), 5mm x 31mm
(3/16" x 1 1/4"), 6mmx31mm (1/4"x1.1/4")

Part No.	Price
110 131	£7.60

PAINT BRUSHES



General Use Paint Brushes
Pure Bristles, Black Wooden
Handles

10 Brushes
Sizes 1/2" to 3"

Part No.	Price
110 119	£6.70

EXHAUST CLAMPS

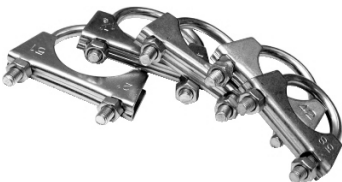

Exhaust Clamps - 'U' Type
Zinc Plated, Quantity: 25

Sizes: 1 5/8" (42mm), 1 11/16"
(43mm), 1 3/4" (45mm), 1 7/8"
(48mm), 2" (50mm), 2 1/8" (54mm),
2 1/4" (58mm)

Part No.	Price
110 118	£13.10

PAINT BRUSHES



High Quality Paint Brushes
Pure Bristles, Maroon Lacquered
Wooden Handles

5 Brushes
Sizes 1/2" to 3"

Part No.	Price
110 156	£9.97

TOOL CLIPS



Tool Clips Closed Type
Carbon Spring Steel
Quantity: 50

Grip Diam: 10-12mm, 13-14mm,
16-16mm, 25-27mm, 32-34mm

Part No.	Price
110 176	£10.55

HAMMER SHAFTS



Wooden Hammer Shafts
Assorted Pack of 5

Sizes: 12", 13", 16", 10" (Club)
Includes Metal Wedges No. 1,2,3,4

Part No.	Price
110 130	£18.94

Assorted Packs

HAMMER WEDGES

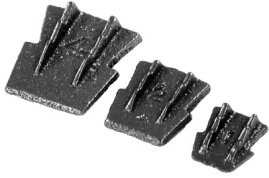

Metal Hammer Wedges
Assorted Pack of 20

Sizes: 1,2,3,4

Part No.	Price
110 174	£8.30

DOMESTIC FUSES



Assorted Pack of Domestic Plug
Mains Fuses
Quantity: 100 Fuses

Contains: 3, 5, & 13 amp fuses

Part No.	Price
110 266	£18.18

GASKET PAPER



Assorted Pack of Gasket Paper
30 Sheets

Sheet Size: 300 x 250mm (12" x 10")
Thickness: 0.4mm (1/64"),
0.8mm (1/32")

Part No.	Price
110 171	£15.83

RUBBER WIRING GROMMETS



Assorted Pack of Rubber Wiring
(Cable) Grommets - Quantity: 120

Holes x Cable Sizes: 6.4 x 4.75, 9.5
x 6.4, 9.5 x 8.0, 12.5 x 9.5, 12.5 x
11.0, 16.0 x 12.0mm

Part No.	Price
110 168	£10.20

SOLDERLESS NIPPLES



Assorted Pack of Solderless Nip-
ples Quantity: 48

Includes:
Barrel Side Screw Size: 6mm
Barrel Top Screw Sizes: 6, 8mm

Part No.	Price
110 115	£32.85

RUBBER BLANKING GROMMETS



Assorted Pack of Rubber Blanking
Grommets - Quantity: 120

To Fit Hole Sizes: 8.0, 9.5, 12.5,
16.3, 19.0 & 25.4mm

Part No.	Price
110 103	£15.23

ANAEROBIC ADHESIVES



Assorted Pack of FIXT Anaerobic
Adhesives - 3 Pack

Contains:
Nut Lock, Stud Lock, Retainer (50 ml)

Part No.	Price
FX085560	£22.97

HEAT SHRINK TUBING

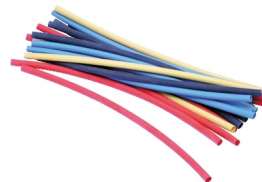

Assorted Box of Heat Shrink Tubing
Polyolefin, 3:1 Shrink Ratio
Quantity: 48 pieces

Size: 4.8mm Diameter x 200mm
Colours: Black, Blue, Red, Yellow

Part No.	Price
110 138	£8.40

METAL CABLE CLIPS - S/A



Self Adhesive Metal Cable Clips
White Acrylic Coated Mild Steel
Quantity: 50

Cable Diameter Sizes: 6, 8, 12mm

Part No.	Price
110 139	£16.11

NYLON P-CLIPS



Nylon P Clips
Pack of 100

Cable Diameter Sizes: 5.0, 6.4, 9.0
& 12.0mm

Part No.	Price
110 100	£7.10

Assorted Packs

RUBBER LINED P-CLIPS



Rubber Lined P-Clips, EPDM Rubber, Zinc Plated Steel
Quantity: 50

Cable Diameter Sizes: 6, 8, 10, 13, 16, 21, 29 & 35mm

Part No.	Price
110 152	£30.63

HI-GRIP HOSE CLIP DISPENSER



HI-GRIP Hose Clip 135 Clip Dispenser Mild Steel, Heavily Zinc Plated

Contains 10 of Each Size: 12, 16, 20, 22, 25, 30, 35, 40, 45, 50

Part No.	Price
110 150	£104.80

NYLON SNAPPER CLIPS



Nylon Snapper Clips - Quick Release, Reusable. Quantity: 35

Ranges: 8.7 - 10.0, 10.8 - 12.3, 12.0 - 13.7, 15.0 - 16.8, 18.1 - 19.9, 22.7 - 24.7, 26.5 - 26.6mm

Part No.	Price
110 160	£10.56

METRIC BARREL OLIVES



Assorted Pack of Metric Brass Barrel Olives
Quantity: 150

Sizes: 5, 6, 8, 10, 12mm

Part No.	Price
110 175	£45.18

HOSE CLIPS - SMALL



Assorted Pack of Hose Clips - Small Sizes, Quantity: 50

Sizes: 12 (000), 16(M00), 20 (00), 22 (0), 25 (0X), 30 (1A), 35 (1), 40 (1X), 50 (2A) & 55 (2)

Part No.	Price
110 136	£26.40

METRIC STEPPED OLIVES



Assorted Pack of Metric Brass Stepped Olives
Quantity: 150

Sizes: 4, 6, 8, 10, 12mm

Part No.	Price
110 122	£42.97

HOSE CLIPS - LARGE



Assorted Pack of Hose Clips - Large Sizes, Quantity: 24

Sizes: 60, 70, 80, 90, 100, 120, 140, 160 (2X, 3, 3X, 4, 4X, 5, 6, 7)

Part No.	Price
110 137	£24.53

IMPERIAL BARREL OLIVES



Assorted Pack of Imperial Brass Barrel Olives
Quantity: 150

Sizes: 5/32", 3/16", 1/4", 5/16", 3/8", 1/2" & 5/8"

Part No.	Price
110 101	£36.77

HOSE CLIP DISPENSER



Hose Clip 100 Clip Dispenser Pack with Flexi Driver
Mild Steel, Zinc Plated

Contains 10 of Each Size: 12, 16, 20, 22, 25, 30, 35, 40, 50, 55

Part No.	Price
110 163	£107.60

IMPERIAL STEPPED OLIVES



Assorted Pack of Imperial Brass Stepped Olives
Quantity: 150

Sizes: 5/32", 3/16", 1/4", 5/16", 3/8", 1/2" & 5/8"

Part No.	Price
110 102	£37.05

Hardware

MILD STEEL BUTT HINGES

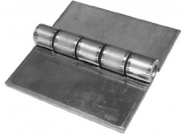

Mild Steel Butt Hinges
Drill or Weld
Self Colour

Part No.	Length	Open Width	Thickness	Price
803 209	75mm	75mm	2mm	£5.75
803 205	152mm	90mm	3mm	£8.82
803 208	102mm	102mm	4mm	£9.79
803 206	152mm	102mm	4.7mm	£13.41

3FT CONTINUOUS HINGE



Mild Steel Continuous Hinge - Undrilled

Length: 36"
Open Width: 76mm
Thickness: 16 Gauge

Part No.	Price
803 210	£12.21

ST/STEEL CONTINUOUS HINGE



Stainless Steel Continuous Hinge - Un-drilled
Length: 36"

Open Width: 50mm
Thickness: 18 Gauge

Part No.	Price
803 211	£15.80

STAINLESS STEEL HINGE



Pre-Drilled Stainless Steel Hinge
Length: 64mm
Open Width: 59mm
Thickness: 2mm

Part No.	Price
803 204	£8.86

MILD STEEL LIFT OFF HINGE



Mild Steel - Drill or Weld
Self Colour
Length: 102mm
Open Width: 76mm
Thickness: 4.5mm

Part No.	Price
803 207	£7.07

PLASTIC PULL HANDLE



Black Rigid Plastic Pull Handle
Length: 246mm (9.7")
Hole Centres: 203mm (8")

Part No.	Price
200 752	£1.35

STEEL CORE PULL HANDLE

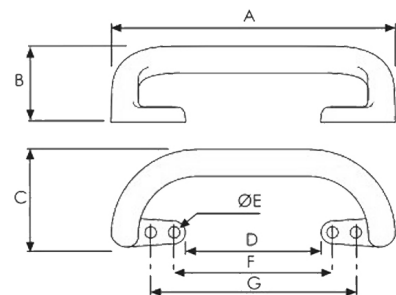

	A	B	C	D	E	F	G	H
METRIC (mm)	296	74	102	141	6	165	213	
IMPERIAL (ins)	11.65	2.91	4.02	5.55	0.24	6.5	8.39	

Part No.	Price	Expanded Polyurethane Foam on a Spring Steel Core. Semi-gloss, Etched Granular Finish. Weight 380g/13.4oz
999 926	£12.68	

DOOR RETAINER



Male/Female Door/Bonnet Retainer

Part No.	Type	Price
0666/001	Female	£1.40
0666/002	Male	£0.26

POLISHED TUBE END CAPS



Polished Tube End Caps
Ribbed Insert for Secure fit

Part No.	Description	Size	Price
921 3036	Rectangular for 2x1" Tube	50.8 x 25.4mm	£0.50
921 3109	Square for 1" Tube	25.4 x 25.4mm	£0.30
921 3090	Square for 1.5" Tube	38.0 x 38.0mm	£0.60
921 3113	Square for 2" Tube	50.8 x 50.8mm	£1.03
921 3134	Round for 1" Tube	24.4mm	£0.30
921 3137	Round for 1.5" Tube	38mm	£0.45
921 3138	Round for 2" Tube	50.8mm	£0.60

HEAVY DUTY RUBBER BUFFER



Ideal for Vehicles & Loading Bays. Reinforced Holes

Length: 250mm
Height: 90mm
Width: 80mm

Part No.	Price
999 925	£7.31

Hardware

1.5MM EDGE TRIM

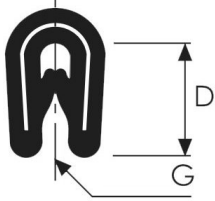

Carrier Depth (D) = 8mm
Grip Range (G) = 0.5 - 1.5mm

Part No.	Length	Price
124 0070	5m	£7.54
124 0071	25m	£37.70

20MM EXTRUDED SEAL

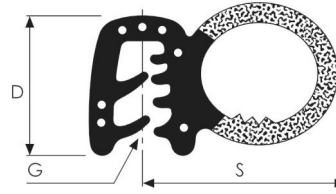

Carrier Depth (D) = 12mm
Seal Dim (S) = 20mm
Grip Range (G) = 1.5 - 2mm

Part No.	Length	Price
124 0076	5m	£13.00
124 0077	25m	£62.40

2.5MM EDGE TRIM

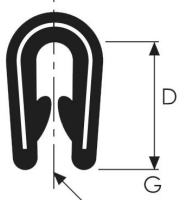

Carrier Depth (D) = 12mm
Grip Range (G) = 0.7 - 2.50mm

Part No.	Length	Price
124 0072	5m	£7.02
124 0073	25m	£35.10

21MM EXTRUDED SEAL

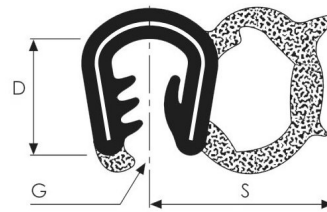

Carrier Depth (D) = 14mm
Seal Dim (S) = 21mm
Grip Range (G) = 3.5 - 5mm

Part No.	Length	Price
124 0078	5m	£16.04
124 0079	25m	£80.17

4MM EDGE TRIM

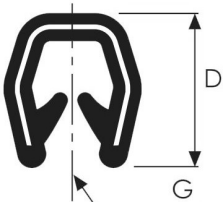

Carrier Depth (D) = 13mm
Grip Range (G) = 2 - 4mm

Part No.	Length	Price
124 0074	5m	£12.48
124 0075	25m	£57.20

16MM EXTRUDED SEAL

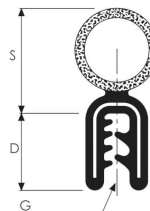

Carrier Depth (D) = 12mm
Seal Dim (S) = 16mm
Grip Range (G) = 1 - 2mm

Part No.	Length	Price
124 0080	5m	£14.04
124 0081	25m	£65.00

PAD BOLTS



Pad (Brenton) Bolts
Black/Galvanised

Part No.	Size	Price
969 265	4"	£2.44
969 266	6"	£2.55
969 268	10"	£5.04

TOWER BOLTS



Tower Bolts
Black/Galvanised

Part No.	Size	Price
969 269	4"	£1.42
969 270	6"	£1.43
969 271	8"	£2.10
969 272	10"	£2.22

Hardware

SPRING BOLTS



Spring Bolts
Zinc Plated

Part No.	Bolt Ø	Bracket	Throw	Price
200 732	13mm	70 x 40mm	30mm	£3.80
200 733	13mm	114 x 40mm	70mm	£4.45
200 734	16mm	140 x 38mm	82mm	£7.91

TOGGLE CLAMPS

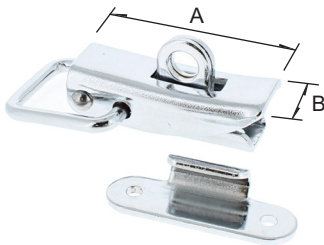

Over Centre Toggle Clamps
Can be secured with lock or pin

Part No.	A	B	Price
200 479	68mm	18mm	£3.47
200 480	68mm	25.4mm	£2.80
200 481	170mm	25.4mm	£5.87

SILVER STEEL



Round Section Tool
Grade Silver Steel

13" Lengths

Part No.	Size	Price
908 018	1/8"	£0.95
908 532	5/32"	£1.40
908 316	3/16"	£1.60
908 014	1/4"	£2.95
908 516	5/16"	£4.10
908 038	3/8"	£4.75
908 716	7/16"	£5.90
908 012	1/2"	£7.90
908 058	5/8"	£10.45
908 034	3/4"	£15.70
908 078	7/8"	£19.25
908 100	1"	£25.90
908 103	3mm	£0.95
908 104	4mm	£1.66
908 105	5mm	£2.22
908 106	6mm	£3.03
908 108	8mm	£4.00
908 110	10mm	£6.36
908 112	12mm	£9.40
908 116	16mm	£13.60
908 120	20mm	£15.50

CABIN HOOKS



Cabin Hook & Catch
Screw Fixing with Counter
Sunk Holes
(screws not included)

Part No.	Length	Price
999 980	150mm	£2.30
999 985	250mm	£1.95

CANOPY DOOR HANDLE



Chrome plated locking
Canopy Door Handle
complete with 2 keys

Part No.	Description	Price
800 1255	Door Handle	£21.90
4222/707	Door Handle - Keyed Alike	£20.58

CANOPY DOOR T-HANDLE



Chrome plated locking T-Handle
complete with 2 keys (64001)

360 degree rotation with no stops

Part No.	Description	Price
200 482	Door Handle	£18.20
64001	Replacement Key	£1.60

BUDGET LOCKS

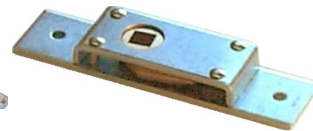

Budget Locks
T-Key Operated

782 055

Part No.	Description	Price
782 015	Left Hand	£2.70
782 025	Right Hand	£3.50
782 055	T Key	£1.95

KEY STEEL



Square Section Key Steel

12" Lengths

Part No.	Size	Price
907 316	3/16"	£0.95
907 014	1/4"	£1.40
907 516	5/16"	£3.50
907 104	4mm	£0.95
907 105	5mm	£2.42
907 106	6mm	£1.35
907 108	8mm	£3.06
907 110	10mm	£2.95
907 112	12mm	£3.50

Hardware

LYNCH PINS



Part No	Pin Diam.	Ring Diam.	Price
LP316	3/16" (5mm)	38mm	£0.32
LP14	1/4" (6mm)	50mm	£0.32
800 430	1/4" (6mm)	70mm	£0.69
LP516	5/16" (8mm)	45mm	£0.32
800 440	5/16" (8mm)	74mm	£0.90
LP38	3/8" (10mm)	70mm	£0.75
LP716	7/16" (11mm)	50mm	£1.50
800 450	3/8" c/w Lock Pin	65mm	£1.50
105 258	16 Assorted (sizes 1/4" - 7/16")		£13.78

R CLIPS



Part No	Wire Diam.	Length	Price
S8	2mm (5/64")	43mm	£0.11
S9	2.5mm (3/32")	46mm	£0.11
S10	3mm (1/8")	67mm	£0.15
S11	3.5mm (9/64")	68mm	£0.16
S12	4mm (5/32")	79mm	£0.17
S13	5mm (13/64")	105mm	£0.23
S14	6mm (1/4")	115mm	£0.56
S15	7mm (9/32")	163mm	£1.09
105 259	50 Assorted (sizes 2 - 6mm, 3/16", 1/4")		£13.97

PROP PINS



16mm (5/8") EN8 Pin
13 Link Mild Steel Chain
54mm I/D Ring
Zinc Plated

Part No	Price
803 242	£1.34

ROTOVATOR CLIPS



Zinc Passivated

Part No	Pin Diam.	Pin Length	Price
S271	1/4" (6mm)	70mm	£1.19
S266	5/16" (8mm)	70mm	£1.20
S273	3/8" (10mm)	70mm	£1.20
S449	7/16" (12mm)	70mm	£1.30

SQUARE ROTOVATOR CLIPS



Zinc Passivated

Part No	Pin Diam.	Pin Length	Price
S272	7/16" (12mm)	50mm	£1.60

COTTER PIN & CHAIN



Forged Cotter Pin
Zinc Plated

Part No	Price
200 916	£3.52

SPRING HOOK & CHAIN



Roller Shutter Spring
Hook
75mm x 200mm
Zinc Plated

Part No	Price
705 124	£5.50

TRESSLE PINS



9.5mm (3/8") EN8 Pin
6 Link Mild Steel Chain
54mm I/D Ring
Zinc Plated

Part No	Price
803 121	£1.73

Materials Handling

NYLON SWIVEL CASTORS



Unbraked Swivel Castors
Nylon Wheels

Part No.	Wheel Ø	Height	Capacity	Price
892 050	50mm (2")	64mm	40kgs	£3.05
892 063	63mm (2.5")	78mm	85kgs	£4.50
892 075	75mm (3")	94mm	120kgs	£5.60
892 100	100mm (4")	125mm	225kgs	£9.90

RUBBER SWIVEL CASTORS



Rubber Swivel Castors
with Roller Bearing Centres

Plate Size: 140 x 110mm

Part No.	Wheel Ø	Height	Capacity	Price
896 150	150mm (6")	195mm	135kgs	£13.55
896 200	200mm (8")	238mm	205kgs	£15.44

BRAKED SWIVEL CASTORS



Braked Swivel Castors
Nylon Wheels

Part No.	Wheel Ø	Height	Capacity	Price
892 575	75mm (3")	94mm	120kgs	£12.10
892 105	100mm (4")	125mm	225kgs	£18.65

RUBBER FIXED CASTORS



Rubber Fixed Castors
with Roller Bearing Centres

Plate Size: 140 x 110mm

Part No.	Wheel Ø	Height	Capacity	Price
897 150	150mm (6")	195mm	135kgs	£10.23
897 200	200mm (8")	238mm	205kgs	£12.35

NYLON FIXED CASTORS



Fixed Castors
Nylon Wheels

Part No.	Wheel Ø	Height	Capacity	Price
893 050	50mm (2")	64mm	40kgs	£2.75
893 063	63mm (2.5")	78mm	85kgs	£2.89
893 075	75mm (3")	94mm	120kgs	£5.72
893 100	100mm (4")	125mm	225kgs	£7.42

RUBBER CASTOR WHEEL



Rubber Castor Wheel Only
with Roller Bearing Centres

Part No.	Wheel Ø	Bore	Capacity	Price
890 250	150mm (6")	20mm	135kgs	£11.45
890 300	200mm (8")	20mm	205kgs	£8.90

NYLON CASTOR WHEELS



Nylon Wheels Only

Part No.	Wheel Ø	Bore	Capacity	Price
894 050	50mm (2")	6mm	40kgs	NLA
894 063	63mm (2.5")	11mm	85kgs	£2.05
894 075	75mm (3")	12mm	120kgs	£2.25
894 100	100mm (4")	15mm	225kgs	£4.24
894 150	150mm (6")	20mm	360kgs	£11.75

RUBBER CASTOR WHEEL SET



4 Piece 4" Rubber Castor
Wheel Set

2 x Fixed, 2 x Swivel
Castors

Part No.	Price
899 100	£25.30

Materials Handling

8" Sweeper Castor Wheels



Heavy duty swivel castor wheels
Steel frame, cast iron hub with roller bearing & greasing point
Mounting bolt dia: 11mm

Part No.	Wheel Material	Wheel Size	Height	Plate Size	Capacity	Price
898 100	Polyurethane	200 x 50mm	245mm	135 x 110mm	1000kgs	£134.50
898 105	Rubber	200 x 50mm	248mm	171 x 137mm	535kgs	£90.80

RUBBER SWIVEL CASTORS



Blue Rubber Swivel Castors

Part No.	Wheel Ø	Height	Capacity	Price
891 085	75mm (3")	95mm	90kgs	£9.79
891 150	100mm (4")	125mm	160kgs	£17.47

RUBBER SWIVEL CASTORS



Single Hole Fixing Grey Rubber Swivel Castors

2" & 3" - 10mm Bolt Fixing
4" - 12mm Bolt Fixing

Part No.	Wheel Ø	Height	Capacity	Price
898 050	50mm (2")	67mm	50kgs	£2.75
898 075	75mm (3")	95mm	70kgs	£3.10
898 200	100mm (4")	130mm	89kgs	£4.90

BLUE RUBBER FIXED CASTORS



Blue Rubber Fixed Castors

Part No.	Wheel Ø	Height	Capacity	Price
891 075	75mm (3")	95mm	90kgs	£8.64
891 105	100mm (4")	125mm	160kgs	£12.55

BRAKED SWIVEL CASTORS



Single Hole Fixing Grey Rubber Braked Swivel Castors

2" & 3" - 10mm Bolt Fixing
4" - 12mm Bolt Fixing

Part No.	Wheel Ø	Height	Capacity	Price
898 051	50mm (2")	67mm	50kgs	£3.85
898 076	75mm (3")	95mm	70kgs	£4.25
898 205	100mm (4")	130mm	89kgs	£6.70

BLUE RUBBER CASTOR WHEEL



Blue Rubber Castor Wheel Only

Part No.	Wheel Ø	Capacity	Price
891 050	75mm (3")	90kgs	£5.90
891 200	100mm (4")	160kgs	£17.60

RUBBER TYRED WHEELS



Rubber Tyred Wheels With Plastic Centres

Part No.	Wheel Ø	Bore	Price
800 176	160mm (6.1/4")	20mm	£6.70
800 174	180mm (7")	1/2"	£8.45
800 175	180mm (7")	3/4"	£8.75
800 171	250mm (10")	1"	£17.92
60/0286	305mm (12")	1"	£18.75

Materials Handling

RUBBER TYRED SOLID WHEELS



Rubber Tyred Wheels
Pressed Steel Hub c/w
Greasing Point & Needle
Bearing
(Suitable for Site Mixers)

Part No.	Wheel Ø	Bore	Price
800 166	205mm (8")	1"	£19.10
800 167	255mm (10")	1"	£38.33

FOLDING PLATFORM TROLLEY



Strong & Lightweight, Folds Flat
Rubber Protective Edges

Length: 630mm
Width: 480mm
Height: 850mm
Capacity: 150kg

Part No.	Price
200 062	£80.70

PNEUMATIC TYRED WHEEL



Pneumatic Tyred Wheel
265 x 85mm c/w Bearing
20mm Bore
2 Ply Tyre Rating Low Speed
Not for Highway Use

Part No.	Price
290 089	£14.25

SACK TRUCK - 200KG



Sack Truck 200 Kilo Capacity
Solid Rubber Tyres
9" Lifting Plate

Part No.	Price
200 097	£79.92

BARROW WHEEL - SOLID TYRE



13" Wheelbarrow Wheel
Metal Centre c/w Grease
Nipple & Solid Rubber Tyre

Bore Dia: 1"
Bore Depth: 65mm

Part No.	Price
800 168	£29.41

COLLAPSABLE SACK TRUCK



Aluminium frame
Folding steel toe plate
Maximum Capacity: 90kg
Weight: 7kg

Part No.	Price
200 007	£91.30

BARROW WHEEL - PNEUMATIC



16" Wheelbarrow Wheel
Metal Centre c/w Grease
Nipple & Needle Bearing
Pneumatic Tyre

Bore Dia: 1"
Bore Depth: 65mm

Part No.	Description	Price
800 169	16" Barrow Wheel	£32.00
800 235	Inner Tube Only	£8.34

WHEELBARROW



Press Pan Heavy Duty
Wheelbarrow

Pneumatic Tyre
85 Litre Capacity (3 cuft)

Part No.	Price
902 2250	£59.33

Materials Handling - Pallet Trucks

Pallet Truck - 2500KG



2500kg Pallet Truck
200° Turning Radius
1092mm Fork Length
565mm Fork Width

Part No.	Description	Price
200 623	Double Wheel	£320.30

Nylon Pallet Truck Roller

Nylon Wheel
Bearing Type: Ball Journal
(Hub Width is Over Bearings)

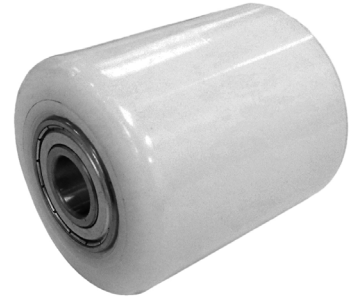

Part No.	I/D Ø	Height	Tread Width	Hub Width	Capacity(ea)	Price
887 060	20mm	82mm	70mm	66mm	700kgs	£17.55
887 030	20mm	82mm	98mm	98mm	1000kgs	£18.55
887 050	20mm	82mm	100mm	96mm	1000kgs	£14.90

Polyurethane/Nylon Pallet Truck Roller



Nylon Centre Wheel with Polyurethane Tyre
Bearing Type: Ball Journal
(Hub Width is Over Bearings)

Part No.	I/D Ø	Height	Tread Width	Hub Width	Capacity(ea)	Price
887 010	20mm	82mm	100mm	96mm	850kgs	£20.63

Polyurethane/Steel Pallet Truck Roller

Steel Centre Wheel with Polyurethane Tyre
Bearing Type: Ball Journal
(Hub Width is Over Bearings)



Part No.	I/D Ø	Height	Tread Width	Hub Width	Capacity(ea)	Price
887 100	20mm	80mm	50mm	50mm	460kgs	£28.85
887 020	20mm	75mm	62mm	62mm	470kgs	£28.51
887 110	20mm	75mm	95mm	95mm	720kgs	£32.44
887 080	20mm	82mm	100mm	96mm	1000kgs	£39.68
887 090	20mm	85mm	100mm	100mm	1000kgs	£41.09

Storage

SINGLE STEPS



Single Steps
340 x 295 x 285mm

Part No.	Price
MP538	£20.48

SIZE 2 STORAGE BINS



Polythene Storage Bins
150 x 100 x 75mm
(6" x 4" x 3")

Packs of 20

Part No.	Colour	Price
895 285	Red	£28.80
895 305	Blue	£27.90

DOUBLE STEPS



Double Steps
Step Height 210 & 425mm

Part No.	Price
MP5385	£33.37

SIZE 3 STORAGE BINS



Polythene Storage Bins
230 x 150 x 130mm
(9" x 6" x 5")

Packs of 10

Part No.	Colour	Price
895 286	Red	£33.90
895 306	Blue	£31.88

MECHANICS CREEPER BOARD



Steel Creeper board with
PVC Padding & Swivel
Castors

Height: 110mm

Part No.	Price
300 300	£108.00

SIZE 4 STORAGE BINS



Polythene Storage Bins
330 x 200 x 130mm
(14" x 8" x 5")

Packs of 10

Part No.	Colour	Price
895 287	Red	£65.92
895 307	Blue	£56.72

CARDBOARD STORAGE BOXES



Cardboard Self Assembly
Storage Boxes - Ideal for
Temporary Storage of
Parts etc.

Per Pack of 50

Part No.	Length	Width	Depth	Price
310 106	300mm	100mm	100mm	£67.05
310 107	300mm	150mm	100mm	£67.10

STORAGE PANELS

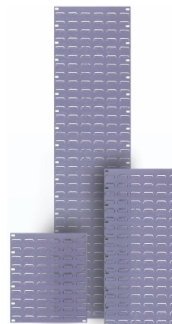

18" Wide Louvered Panels
Wall Mountable Steel Panels
for Storage Bins

Per Pack of 2

Part No.	Size	Price
895 290	460 x 640mm	£60.50
895 291	460 x 950mm	£84.10

Security

BUDGET CHROME PADLOCKS



Budget Laminated Chrome Padlocks

Part No.	Base Size	Price
200 464	40mm	£3.76
200 465	50mm	£5.32
200 466	64mm	NLA

BRASS PADLOCKS



ABUS 65 Series Brass Padlocks

Hardened Steel Shackle
Double Bolted



Part No.	Shackle Ø	Base	Price
65C30	5mm	30mm	£8.88
65C40	6.5mm	40mm	£11.13
65C50	8mm	50mm	£17.87

KEYED ALIKE - BRASS



Budget Laminated Chrome Padlocks



Part No.	Shackle Ø	Base	Price
85C40	6.5mm	40mm	£23.98
850 120 0723	Spare Key for 85C40		£4.47
85C50	8mm	50mm	£33.30
850 120 2745	Spare Key for 85C50		£4.46

LONG SHANK BRASS PADLOCK



Tough Reliable Brass Padlocks
Hardened Steel Shackle
6mm Shackle
40mm Base
63mm Shackle Height



Part No.	Price
65/40/63	£15.15

TITALIUM PADLOCKS



ABUS 54TI Series
Aluminium Titanium Alloy Body
Cheaper & Lighter than their
Brass Equivalents with no
Compromise on Security



Part No.	Shackle Ø	Base	Price
54TI30	5mm	30mm	£6.97
54TI50	8mm	50mm	£14.12

KEYED ALIKE - TITALIUM



64TI Series - Keyed Alike

Aluminium Titanium Alloy Body
Cheaper & Lighter than their
Brass Equivalents with no
Compromise on Security



Part No.	Shackle Ø	Base	Price
64TI30	5mm	30mm	£7.78
ABUKEYCUT 6312	Spare Key for 64TI30		£4.29
64TI40	6.5mm	40mm	£10.40
ABUKEYCUT 6411	Spare Key for 64TI40		£4.47
64TI50	8mm	50mm	£16.23
ABUKEYCUT 6512	Spare Key for 64TI50		£4.47

158/50 COMBINATION PADLOCK



Heavy Duty 4 Digit Combination
Padlock - Hardened Steel
Shackle, Solid Die-Cast Zinc Body

8mm Shackle
52mm Base



Part No.	Price
158/50	£25.62

160/50 COMBINATION PADLOCK



Tough Die-Cast Body
Chrome Plated Casing
Hardened Steel Shackle

7.5mm Shackle
50mm Base



Part No.	Price
160/50	£39.92

Security

82/70 SHUTTER PADLOCK



Hardened Alloy Steel Shackle
Solid Brass Body

12mm Shackle
70mm Base
Level 7 GPS Rated



Part No.	Description	Price
908 270	82/70 Padlock	£27.07
900 070	82/70 Padlock - Keyed Alike	£29.77
900 075	Spare Key (Keyed Alike Only)	£4.29

82/90 SHUTTER PADLOCK



Hardened Alloy Steel Shackle
Solid Brass Body

12mm Shackle
90mm Base
Level 8 GPS Rated



Part No.	Description	Price
908 290	82/90 Padlock	£41.82
900 090	82/90 Padlock - Keyed Alike	£45.98
900 095	Spare Key (Keyed Alike Only)	£4.46

92/80 SHUTTER PADLOCK



Hardened Alloy Steel Shackle
Solid Brass Body Enclosed in
Hardened Steel Case

12mm Shackle
78mm Base
Level 8 GPS Rated



Part No.	Description	Price
909 280	92/80 Padlock	£70.40
900 100	92/80 Padlock - Keyed Alike	£77.48
900 105	Spare Key (Keyed Alike Only)	£4.47

24IB60 DISCUS PADLOCK



Stainless Steel Shackle
Stainless Steel Body

8mm Shackle
60mm Diam
Level 7 GPS Rated



Part No.	Price
902 460	£35.40

26/70 DISCUS PADLOCK



Stainless Steel Shackle
Stainless Steel Body

10mm Shackle
70mm Diam
Level 8 GPS Rated



Part No.	Price
902 670	£41.37

20/80 DISCUS PADLOCK



Black Chrome Alloy Steel
Shackle, Stainless Steel Body

30,000 Key Variants
11mm Shackle
80mm Diam
Level 9 GPS Rated



Part No.	Price
902 080	£65.02

37/55 GRANIT PADLOCK



Full Insurance, Open Shackle
Level 10 GPS Rated High Security
Padlock

11mm Shackle
60mm Base
27mm Horizontal
Clearance



Part No.	Description	Price
903 759	37/55 Padlock	£103.10
500 001	Spare Key - Please Provide Key Number	£14.29

37/60 GRANIT PADLOCK



Full Insurance, Closed Shackle
Level 10 GPS Rated High Security
Padlock

11mm Shackle
60mm Base
17mm Horizontal
Clearance



Part No.	Description	Price
903 760	37/60 Padlock	£127.50
500 001	Spare Key - Please Provide Key Number	£14.29

Security

INSURANCE HASP & STAPLE



130/180 Insurance Approved Hasp & Staple

Length: 180mm
Width: 78mm
Staple /Hole Dia: 13.3mm



Part No.	Price
200 467	£106.30

5 LEVER MORTICE DEADLOCK



5-Lever Mortice Deadlock
Satin Chrome Finish
60mm (2.1/2") Box
c/w 3 steel nickel plated keys



Part No.	Description	Price
200 928	5-Lever Mortice Deadlock	£40.27

DISKUS HASP & STAPLE



140/120 Insurance Approved Hasp & Staple for Diskus Padlocks

Length: 120mm
Width: 56mm
Staple /Hole Dia: 12.5mm



Part No.	Price
200 468	£17.25

LOCKABLE KEY CABINETS



Heavy duty steel cabinet with lock for hanging up to 93 keys.

Supplied with labels, wall fixings and two keys

Key fobs also available in 50, 100 & 500 Packs.

Part No.	Hooks	Size	Price
571 203	20 Hook	200 x 160 x 80mm	£22.46
563 805	48 Hook	250 x 180 x 80mm	£27.65
563 806	93 Hook	300 x 240 x 80mm	£35.87
200 449	Clear Paper Insert Key Fob (each)	35mm x 24mm	£0.35

HASP & STAPLES

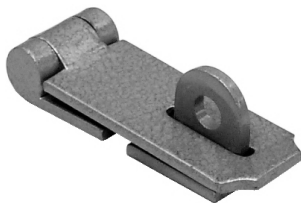

Budget Hasp & Staples
Battleship Grey

Part No.	Length	Width	Price
895 051	90mm	30mm	£14.36
895 053	115mm	40mm	£6.79
895 054	140mm	40mm	£9.57
895 055	180mm	50mm	£6.75

MASTERLOCK KEY STORE



Masterlock 5401 Key Store
Stores up to 5 Keys
Simple 4 Digit Combination
Suitable for Outdoor Use

8.5 x 12 x 3.5cm

Part No.	Price
200 868	£29.52

VAN DOOR LOCK



Suitable for vans, trucks, garages, sheds or any other outward opening double doors

Supplied with an ABUS 23/70 70mm high security padlock



Part No.	Price
D141/200	£52.42

LUBRICATING PADLOCK SPRAY



PS88 Lubricating Padlock Spray 50ml
Protects Against Weather & Corrosion
Lubricates & Loosens Sticky Mechanisms



Part No.	Price
858 292	£9.98

Security

COBRA SECURITY CABLES



Flexible High Tensile Steel Loop Cable
Resists Cutting
Coated in Clear Vinyl
Lightweight Alternative to Security Chain



Part No.	Length	Price
200 477	2m	£24.55
200 953	5m	£46.45

COATED SECURITY CHAIN



Hardened Security Chain
Red Thermowrapped Sheath

(not suitable for lifting)

Part No.	Link	Length	Price
ATC6	6mm	1.2m	£4.63
ATC8	8mm	1.2m	£15.01
ATC 10	10mm	1.5m	£30.61

MASTER LOCK U-BAR & CABLE



MasterLock High Security U-Bar with 1.2m Looped End Cable
Height: 280mm
Clearance: 110mm
Diameter: 13mm
Security Level: 10

Part No.	Price
MLK8285E	£45.03

GALVANISED CHAIN

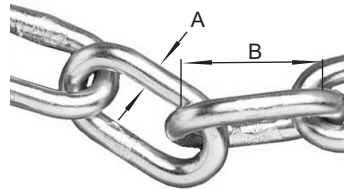

Zinc Galvanised, General Purpose Chain

(not suitable for lifting)

Part No.	A	B	Length	Price
200 463	3mm	16mm	10m	£12.50
200 462	4mm	26mm	10m	£28.97
200 459	6mm	42mm	10m	£53.27
200 458	6mm	42mm	15m	£51.50
200 457	8mm	52mm	10m	£53.20
906 1000	10mm	53mm	10m	£134.97
906 1001	13mm	82mm	10m	£73.50

YALE NIGHTLATCH

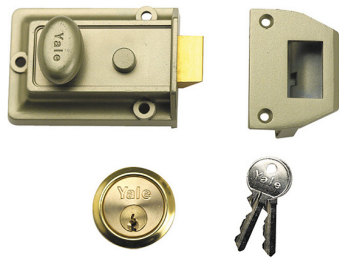

Hardened Case Finished in Electro Nickel Brass and the Cylinder Is Finished in Polished Brass
60mm Backset (edge of door to keyhole centre)
Supplied with 2 x keys
Security Rating: Standard

Part No.	Price
YALP77ENBPB	£29.25

2M SECURITY CHAIN



Hardened Security Chain c/w Fabric Sleeve, Link Thickness: 10mm, Length: 2m

Part No.	Price
888 610	£30.90

YALE RIM LOCK - BRASS

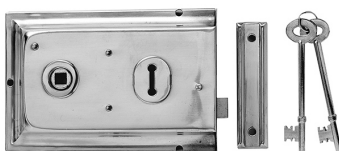

Operated by Key From Either Side of the Door, For Use With Rim Lock Knob w/Handles
Case Finish: Brass
Size: 156 x 104mm
Standard Security Rating
Supplied with 2 keys

Part No.	Price
YALP334PB	£24.65

MASTER LOCK CASH BOX



Master Lock Medium-sized Cash Box Has a Convenient Fold-away Handle and Removable Tray
Steel Construction
Ext. Dimensions: 9.3x30x23.5cm
Int. Dimensions: 8.7x29.7x22.9cm
Interior Volume: 5.91 Litre
Weight: 2.1kg

Part No.	Price
MLKCB12ML	£43.42

Adhesive Tape

MASKING TAPE



High Quality Masking Tape
50m Rolls

Part No.	Width	Price
895 336	25mm (1")	£1.19
895 337	50mm (2")	£1.95

GAFFER TAPE



Gaffer (Tank) Cloth Tape
50mm x 50m Rolls

Part No.	Colour	Price
895 134	Black	£3.95
895 001	White	£3.95
895 000	Silver	£3.95

CLEAR ADHESIVE TAPE



Clear Adhesive Tape
25mm x 66m Rolls

Part No.	Price
895 103	£0.90

DOUBLE SIDED TAPE - WHITE



White Double Sided
Adhesive Foam Tape
Internal Use Only
10m Rolls

Part No.	Width	Price
895 091	12mm (1/2")	£3.40
895 092	19mm (3/4")	£4.50
895 094	25mm (1")	£6.28

DOUBLE SIDED TAPE - BLACK



Black Double Sided
Adhesive Foam Tape
External/Automotive Use
10m Rolls

Part No.	Width	Price
895 096	12mm (1/2")	£2.92
895 097	19mm (3/4")	£4.27
895 098	25mm (1")	£5.55
895 102	50mm (2")	£10.90

SELF-AMALGAMATING TAPE



Black RUBAWRAP
Self-Amalgamating Tape
Forms a Solid Synthetic
Rubber Layer.
Differs from traditional sticky
tapes in that it is designed to only
stick to the previous layer of itself.
5m Rolls

Part No.	Width	Price
895 115	25mm (1")	£5.23
895 107	50mm (2")	£8.28

PTFE TAPE



PTFE Thread Sealing Tape
12mm x 12m Rolls on
Plastic Spools

Part No.	Price
865 130	£0.35

GAS PTFE TAPE



PTFE Gas Sealing Tape
12mm x 12m Rolls on
Plastic Spools

Part No.	Price
895 104	£0.85

Adhesive Tape

INSULATION TAPE



High Quality, Flame Retardant
PVC Insulation Tape to BS3924

20m Rolls

Part No.	Colour	Width	Price
225 279	Black	19mm	£0.65
225 288	Black	50mm	£2.27
225 290	Grey	19mm	£0.83
225 281	Red	19mm	£0.82
225 282	Blue	19mm	£0.83
225 283	Green	19mm	£0.83
225 284	Yellow	19mm	£0.83
225 285	White	19mm	£0.82
225 286	Brown	19mm	£0.83
225 287	Green/Yellow	19mm	£0.83
225 280	Assorted Pack of 10 Rolls/ 19mm		£8.10

DO NOT USE - WARNING TAPE



Do Not Use - Warning Tape
Size: 50mm x 66mtr
White background with Red Text

Part No.	Price
804 715	£4.77

PARCEL TAPE



Parcel/Packing Tape
50mm x 66m Rolls
Brown Polypropylene

Part No.	Price
895 079	£1.75

GOLD CLEAR PARCEL TAPE



Gold Clear Parcel Tape
48mm x 150m Roll

Part No.	Price
895 036	£2.51

PARCEL TAPE DISPENSER



Packing Tape Dispenser Gun
For 66mm Rolls (Suits 895 079)

Part No.	Price
895 078	£8.20

ANTI-SLIP TAPE



Resin Bonded Grit
Ideal for Entrances, Stairs,
Steps & Ramps
For Use On Metal, Concrete,
Wood & Tiled surfaces
For Indoors & Outside Use
Self-Adhesive

Part No.	Colour	Width	Length	Price
200 796	Black	25mm	5m	£4.50
200 962	Black	25mm	18m	£9.73
200 798	Black	50mm	18m	£18.50
895 329	Black/Yellow	50mm	18m	£36.75
200 799	Black	75mm	18m	£43.67
200 313	Black	150mm	18m	£82.42

HAZARD WARNING TAPE



Self-Adhesive PVC
Chevron Hazard Warning
Tape
50mm x 33m Rolls

Part No.	Colour	Price
895 345	Black/Yellow	£3.45
895 346	Red/White	£3.70
895 347	Green/White	£3.92

VELCRO



Black Velcro
5m & 25m Lengths

Part No.	Type	Width	Length	Price
804 812	Hook & Loop	16mm	5m	£6.25
804 813	Hook & Loop	16mm	25m	£27.20
804 814	Hook Only	20mm	5m	£4.58
804 815	Loop Only	20mm	5m	£4.30
804 816	Hook Only	20mm	25m	£25.75
804 817	Loop Only	20mm	25m	£20.08

Floor Marking

NON ADHESIVE ZEBRA TAPE



Non-Adhesive Chevron
Barrier Tape

70mm Wide

Part No.	Colour	Length	Price
200 310	Red/White	100m	£6.21
200 311	Red/White	500m	£8.50
200 312	Yellow/Black	500m	£9.35

LINE MARKING SPRAY



Aerosol Line Markers
Produces up to 100m x 50mm
Line

728ml Aerosol Cans

Part No.	Colour	Suggested Use	Price
200 564	White	General	£6.20
200 563	Black	Deletion	£6.20
200 560	Red	Danger	£6.20
200 562	Blue	Protection	£6.20
200 561	Green	Direction	£6.20
200 858	Yellow	Hazard/Caution	£6.20

LINE MARKING APPLICATORS



2 & 4 Wheeled & Hand Held Applicators

For Use With Line Marking Spray

Part No.	Link	Price
200 859	2 Wheeled Applicator	£146.40
200 856	4 Wheeled Applicator	£182.40
AERHHA2	Hand Held Applicator	£22.50

SIGNFIX BANDING TOOL



Made from Forged Alloy Steel

Heavy Duty Tool for Secure
Fixing of Signs to Posts,
Hoses & Pipework

Part No.	Price
200 726	£74.49

SIGNFIX S/STEEL BANDING



SignFix Stainless Steel
Banding

30m Rolls

Part No.	Width	Price
200 728	12mm	£39.08
200 727	19mm	£57.36

SIGNFIX BANDING CLIPS



SignFix Stainless Steel
Banding Clips

Box of 100

Part No.	Width	Price
200 729	12mm	NLA
200 730	19mm	£42.91

ROAD SIGN CLIPS



Zinc Plated Steel Road Sign
Clips

For Secure Fixing of Road
Signs to Metal Frames

Part No.	Price (ea)
200 033	£0.24

Packaging



Polypropylene Strapping Starter Kit

12mm Polypropylene Strapping Starter Kit

Kit Includes:

- 1500m Roll 12mm Poly Strapping (200kg Breaking Strain)
- 12mm Tensioning Tool
- 12mm Sealing Tool
- Box of 1000 12mm Metal Seals

Part No.	Price
960 800	£99.00

12MM POLY STRAPPING - 130KG



12mm Polypropylene Strapping - White

130kg Breaking Strain
0.55mm Thickness
2000m Per Roll

Part No.	Price
P12/150	£45.00

12MM POLY SEALER



12mm Poly Strapping Sealing Tool

For use with 12mm black (200kg) or white (150kg) polypropylene strapping

Part No.	Price
3212/BS	£30.73

12MM POLY STRAPPING - 180KG



12mm Polypropylene Strapping - Black

180kg Breaking Strain
0.7mm Thickness
1500m Per Roll

Part No.	Price
P12/200	£32.65

12MM POLY TENSIONER



12mm Poly Strapping Tensioner Tool

For use with 12mm black (200kg) or white (150kg) polypropylene strapping

Part No.	Price
3215/BT	£30.73

POLY STRAPPING SEALS



Metal Strapping Seals for 12mm Poly Strapping

Box of 1000

Part No.	Price
12/25/D	£10.20

POLY STRAPPING DISPENSER



Dispenser Stand for 12mm Polypropylene Strapping

Part No.	Price
D/82	£59.00

PLASTIC EDGE PROTECTORS



Safeguard Large Plastic Edge Protectors
Suitable for Poly & Steel Banding
Reduces Risk of Strap Slippage

Pack Size - 1000

Part No.	Price
1000/CPL	£37.08

PLASTIC BUCKLES

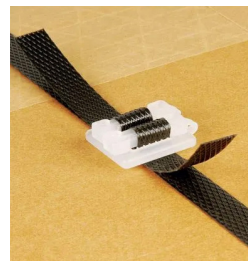

Plastic Buckles - Pack of 1000
Used with 12mm polypropylene strap.
For manual strapping.
100% recyclable.

Part No.	Type	Price
PB12W	Standard	£20.93
PB12WHD	Heavy Duty	£29.82

Packaging

STEEL BANDING

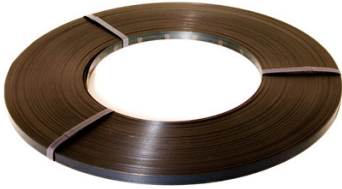

Steel Banding used for Heavy Duty Applications up to 781kg Breaking Strain

(extra carriage may be chargeable when ordering multiple rolls)

Part No.	Size	B/S	Length	Price
PST13/1	13mm	518kg	330m	£94.20
SST19/1	19mm	775kg	333m	£79.50

19MM STEEL BANDING KIT



19mm Steel Banding Starter Kit

Kit contains:
- Roll of 19mm strapping
- Box of 1000 seals
- Tensioning tool
- Sealing tool
- Mobile coil holder

Part No.	Price
960 801	£385.00

STEEL BANDING SEALS

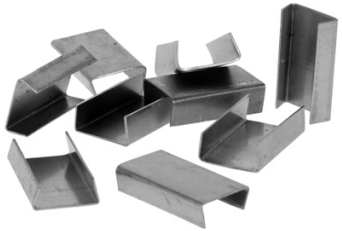

Steel Banding Seals
13mm 1000 pcs
19mm 2000 pcs

Part No.	Size	Price
PST25S	13mm	£14.87
BS19	19mm	POA

STEEL BANDING TENSIONER



Tensioning Tool for 13mm-19mm Steel Banding.

Part No.	Price
T19	£99.90

STEEL BANDING COIL HOLDER



Heavy Duty Mobile Coil Holder On Wheels

Complete With Plastic Tray For Seals

Part No.	Price
PSM/30	£196.70

STEEL BANDING SEALER



Sealing Tools for Steel Banding

2 Sizes Available for 13mm & 19mm Banding

Part No.	Size	Price
PST4	13mm	£56.18
S19	19mm	£47.28

STRETCH FILM KIT



Box of 12 Rolls (15mu 100mm wide x 150m)
1 Easy Grip Handle

Part No.	Price
HSP/100	£27.51

COMBI TENSIONER & CRIMPER



12mm Budget Combination Tensioner / Crimper Strapping Tool for 12mm PP strap

Part No.	Size	Price
P/3010	12mm	£138.00

STRETCH FILM REFILLS



Two options of thicknesses to refill HWSC

Part No.	Thickness	Colour	Price
HWF100	15mu	Clear	£1.96
HWF17	17mu	Clear	£1.92

STEEL BANDING SHEARS



Heavy Duty Steel Banding Safety Shears for 13mm & 19mm Banding, Holds Banding While Cutting to Required Length

Part No.	Price
SSC/30	£45.84

Packaging

PALLET WRAP



Polyethylene Stretch Film
Secures Pallets & Provides
Water Resistance & Stability
During Transport or Storage

Part No.	Thickness	Colour	Size	Price
200 715	17 micron	White	300m Roll	£12.01
200 716	17 micron	White	6x 300m Rolls	£68.00
200 731	25 micron	Black	250m Roll	£11.95

PALLET WRAP DISPENSER



Robust Construction
Ideal For Wrapping Standard
Core Pallet Film
Twist Grip Handle For Tension
Control

Part No.	Price
200 717	£26.24

SCISSORS



Stainless Steel with
Moulded Plastic Handle

Serrated Cutting Blade
8.1/2" Long

Part No.	Price
200 055	NLA

STAPLE GUN - RAPID 13



Fast & Easy Loading Using
Fine Wire Staples
Ideal for Fabrics & Leather

Accepts 13/4, 13/6 & 13/8mm
Staples

Part No.	Price
200 713	£39.01

CARDBOARD LABELS



Cardboard Labels - Unstrung
120 x 60mm

Write on with Pen or Marker

Part No.	Colour	Price (per 100)
310 080	Green	£5.80
310 081	Red	£5.80
310 082	Manila	£6.67

STAPLE GUN - RAPID 33



Heavy Duty
Ideal for Textiles, Canvas,
Fabric, Netting & Leather

Accepts 13/6, 13/8, 13/10
& 13/14mm Staples

Part No.	Price
200 714	£100.10

LABEL CLIPS - 3/4"

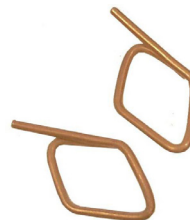

Diamond Shaped Label Clips

100 Per Pack

Part No.	Price (per 100)
310 099	£2.40

STAPLES



13/ Range Staples for use
with RAPID R13, R23 & R33
Staple Guns

Boxes of 5000

Part No.	Length	Price
200 708	4mm	£9.35
200 711	10mm	£13.00
200 712	14mm	£15.45

ALUMINIUM PLATES



Aluminium Plates for Fleet
Numbers
70 x 30 x 2mm (undrilled)

Part No.	Price
310 090	£0.96

Packaging

POLYPROPYLENE BAGS



Woven Polypropylene Bags

Part No.	Size	Thickness	Price (ea)
310 091	38 x 50cm	850 Denier	£0.25
310 092	45 x 60cm	850 Denier	£0.28
310 096	45 x 60cm	1500 Denier	£0.60
310 093	45 x 76cm	850 Denier	£0.30
310 094	50 x 90cm	850 Denier	£0.35
310 095	60 x 100cm	850 Denier	£0.45

1 TON BAG



Constructed Of High Quality, Tightly Woven Polypropylene Transport Sand, Mulch, Debris, Leaves etc.
Size: 90 x 90 x 90cm

Part No.	Price
960 900	£5.50

BLACK REFUSE SACKS



Black Refuse Sacks

Part No.	Price (ea)
895 296	£0.22

HEAVY DUTY RUBBLE SACK



Heavy Duty Polythene Rubble Sacks
Size: 55 x 90cm
500 Gauge

Part No.	Price (ea)
310 097	£0.50

HESSIAN SANDBAG & TIE



Hessian Sandbag c/w Tie
Size 330 x 760mm

Part No.	Price (ea)
310 100	£0.80

POLYPROPYLENE STRING



Polypropylene String Bulk Rolls

Part No.	Weight	Length	Mtrs/kg	Price
310 083	1kg	1400m	1400	£11.16
310 084	4.5kg	2025m	450	£23.18
310 085	4.5kg	1575m	350	£23.18
310 086	4.5kg	765m	170	£23.18

HESSIAN SACKS



Robust, Breathable Hessian Storage Sacks

Sold Singly

Part No.	Width	Height	Price (ea)
960 300	300mm	450mm	£0.86
960 450	450mm	600mm	£1.42
960 500	500mm	800mm	£1.85
960 600	600mm	1000mm	£2.60

CLEAR POLYTHENE BAGS

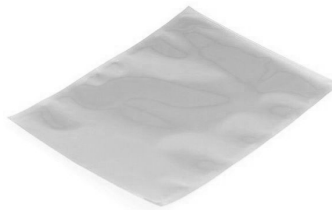

Heavy Duty 500 Gauge Polythene Bags

Packs of 100

Part No.	Width	Height	Price
310 101	15cm	24cm	£5.95
310 102	23cm	30cm	£11.50
310 103	25cm	38cm	£15.17
310 104	30cm	45cm	£21.17
310 105	40cm	50cm	£26.67

JIFFY BAGS



White Padded Jiffy Bags

Part No.	Size	Width	Height	Price (ea)
960 201	E/2	220mm	250mm	£0.35
960 202	H/5	270mm	350mm	£0.58

Cleaning Products

WIRE TIES



Wire Ties - Self Colour
For Tying Sacks and Bags
Use with Wire Puller
(Part No. 200 718)

Packs of 1000

Part No.	Length	Price
200 719	6"	£14.20
200 720	8"	£17.00
200 721	10"	£18.88
200 722	12"	£23.60
200 723	14"	NLA

HESSIAN CLOTH



Hessian Cloth Natural Brown
Sheet 252 gms/m²

Available in 10m & 25m Rolls

Part No.	Width	Length	Price
310 700	102cm	10m	£18.68
310 725	102cm	25m	£42.92
310 750	275cm	10m	£26.61
310 775	275cm	25m	£63.52
310 785	366cm	10m	£35.19
310 795	366cm	25m	£82.40

WIRE TIE PULLER

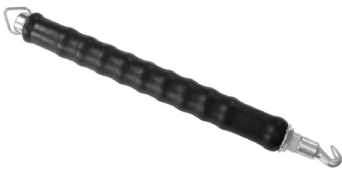

Drillapararat 4460 Wire Tie
Puller

Part No.	Price
200 718	£24.10

POLISHING CLOTH



Polishing Cloth
800g Stockinette Roll
14.6m roll

Part No.	Price
110 121	£7.30

DISH CLOTH



Fibre Dish Cloth

Part No.	Price (ea)
895 354	£0.80

YELLOW DUSTER



Yellow Polishing Dusters
10 Pack

Part No.	Price
110 126	£7.38

CLEANING CLOTH



Cleaning Cloth
800g Stockinette Roll
6m roll

Part No.	Price
110 120	£7.57

10 KG BULK RAGS - WHITE



White Cotton Rags
for Wiping & Polishing

Part No.	Price
200 908	£23.50

NYLON SCOURING PAD



Green Nylon Scouring Pad

Part No.	Price (ea)
895 357	£1.46

10 KG BULK RAGS - MIXED



Various Types of Material
inc Cotton & Towelling
for Wiping & Polishing

Part No.	Price
200 780	£12.40

Cleaning Products

WOODEN HAND BRUSH



Wooden Hand Brush
Soft Bristles

Part No.	Price
895 173	£2.04

12" SOFT BROOM HEAD



Soft Coco Bristle Broom Head
300mm (12") Wide

(suits wooden stale 895 171)

Part No.	Price
895 168	£3.86

PLASTIC DUSTPAN & BRUSH



Plastic Dustpan & Clip-on
Brush
Soft Nylon Bristles

Part No.	Price
895 462	£4.25

12" STIFF YARD BRUSH HEAD



Stiff Yard Brush
300mm (12") Wide

(suits wooden stale 895 453)

Part No.	Price
895 456	£5.80

METAL HOODED DUSTPAN



Metal Hooded Dustpan
Black Painted Finish

Part No.	Price
895 461	£6.83

METAL HAND SHOVEL



Metal Hand Shovel
with Wooden Handle

Part No.	Price
895 174	£4.33

COTTON MOP HEADS



Cotton Mop Heads
Size 14

(suits stale - 895 171)

Part No.	Description	Price
895 170	Plastic Head	£2.56
895 459	Metal Head	£2.60

24" BROOM HEAD



610mm (24") Broom Head
Soft Coco Bristles

(suits wooden stale 895 453)

Part No.	Description	Price
895 452	Soft Bristle	£8.82
896 453	Stiff Bristle	£10.69
895 450	Metal Broom Support	£2.75

BROOM HANDLES



Wooden Broom Stales
Floor Squeegee Head Available
for 895 453 (Part No. 895 175)

Part No.	Dia.	Length	Price
895 171	24mm	4ft	£2.50
895 453	29mm	5ft	£3.95

MOP BUCKETS



Plastic Mop Bucket made from
Strong Polypropylene

Steel Bucket Zinc Galvanised

12 litre Capacity

Part No.	Description	Price
999 590	Plastic	£6.71
895 185	Metal	£21.42

Washroom

HAND TOWELS



Citrus-based formula combined with a tough, textured towel to loosen, dissolve and absorb dirt and grease

Tub of 72 Towels

Part No.	Price
200 577	£18.54

BIG WIPES



Industrial Degreasing Towels
Tough enough for use on tools, workbenches, engines etc.
Gentle enough to use on hands

Meets EU Regulation 1223/2009

Tub of 80 Wipes

Part No.	Description	Price
200 211	Black - Multi Purpose	£10.07
BGW2420	Red - Heavy Duty	£13.32
BGW2440	Green - Eco Friendly	£14.12

SWARFEGA HAND SOAP



Heavy-duty, gel formula hand cleaner that quickly removes deeply ingrained oil and grease.

Contains non-abrasive micro-polymer granules. With added conditioner

4.5 litre Tub

Part No.	Description	Price
200 787	4.5 litre Tub	£47.90
200 788	Hand Pump for 200 787	£3.85

HEAVY DUTY XL WIPES



Muckyz XL Textured Wipes

Hand, machinery, and tool wipes. Removes silicone, paint, sealant, adhesive, bitumen, oil, grease, expanding foam and dirt.

Tub of 100 Wipes

Part No.	Price
934 1302	£3.99

LOCTITE 7850 ORANGE



LOCTITE 7850 Hand Cleaner with pumice. Contains Jojoba, lanolin & aloe for added skin conditioning & protection, Citrus fragrance, works with or without water

3 litre dispenser



Part No.	Price
865 508	£29.50

BARRIER CREAM



Barrier Cream 1 Litre Bottle
Non-Greasy, Non-Toxic

Part No.	Price
865 410	£7.00

300MM WINDOW SQUEEGEE



For Wiping Away Surplus Liquids on Windowpanes or Vinyl Floors etc

Width: 300mm

Part No.	Price
999 950	£6.62

LIQUID HAND CLEANER



Anti-Bacterial Hand Soap
Kills 99.9% of Germs

2 x 5 Litre

Part No.	Price
865 503	£23.58

PLASTIC NAIL BRUSH

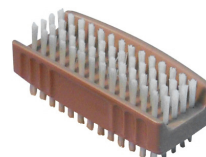

4" Plastic Nail Brush

Part No.	Price
895 172	£0.95

Washroom

460 TEA BAGS



PG Tips Pyramid Tea Bags
Pack Size: 920g
Pack of 460 Tea Bags

Part No.	Price
600 043	£18.36

COFFEE - 750G



Nescafe Original Granules
Double Filter, Full Flavour
Makes Approximately 416 Cups
Sold in 750g

Part No.	Price
COFFEE	£38.76

1KG SUGAR



Tate + Lyle Granulated Sugar
Fair Trade
1kg Bag

Part No.	Price
600 047	£3.73

1KG COFFEE MATE



Nestle Coffee Mate Whitener
For Creamier Tasting Coffee
Sold in 1kg

Part No.	Price
COFFEE MATE	NLA

TEA TOWELS 10PK



Chequered Tea Towels
High Quality Cleaning Product
Colours May Vary
Pack of 10

Part No.	Price
600 038	£7.90

SKIN SAFETY DISPENSERS



Deb Step 1 Skin Protection 1 Litre
Dispenser
Extra Protection Pre-Work Skin
Cream for Wet & Dry Work
Supplied Without Refill

Part No.	Price
895 495	£16.98

SCOURER SPONGE



Scourer Sponge with Hand Grip
14cm x 7cm x 4.5cm
Sold Individually

Part No.	Price
600 030	£0.50

DEB HANDWASH



Cream Hand Cleaner available in
2L and 4L Cartridges

Part No.	Type	Size	Price
865 7104	Blue	2L	£17.43
865 711		4L	£33.08
865 524	Lime	2L	£21.50
865 525		4L	£40.83



Deb Step 2 Heavy Duty Hand
Cleaner 2 Litre Dispenser
Use with Deb Hand Cleaner Top
Up Packs
Supplied Without Refill

Part No.	Price
895 496	£22.28



Deb Step 3 Pure Restore 1 Litre
Dispenser
Super Hydrating After Work
Conditioning Cream
Supplied Without Refill

Part No.	Price
895 498	£16.72

Washroom

RUBBER PLUNGER



5" Diameter Rubber
Plunger
Beech handle

Part No.	Price
804 950	£3.82

WHITE TOILET ROLLS - 36 PACK



White Toilet Rolls

Pack of 36

Part No.	Price
VP507	£17.30

CENTRE FEED PAPER TOWEL



Blue Paper Rolls - 2 Ply
Centre Feed Continuous Sheet
190mm x 150m
(Suits PP092 Dispenser)
Case of 6 Rolls

Part No.	Price
PD80SP/21	£19.95

JUMBO TOILET ROLL



Mini Jumbo Toilet Roll
Length: 150m

Pack of 12 Rolls

Part No.	Price
600 006	£28.50

CENTRE FEED DISPENSER



Centre Feed Roll Dispenser
Plastic - Wall Mounted

Part No.	Price
PP092	£35.14

JUMBO ROLL DISPENSER



Mini Jumbo Toilet Roll
Dispenser

Part No.	Price
600 007	£23.63

PAPER ROLL - 2 PLY



Bulk Paper Roll - 2 Ply
1000 Sheets
400 Metre Rolls

Part No.	Colour	Width	Price
PD107	Blue	370mm	£26.50
PD117	White	260mm	£21.96

C-FOLD HAND TOWELS



C-Fold Paper Hand Towels

Approx 2500 per Box

Part No.	Price
600 004	£18.37

PAPER ROLL DISPENSER



Floorstand Dispenser
For Blue & White Paper Rolls

Part No.	Price
PM97	£69.18

C-FOLD TOWEL DISPENSER



C-Fold Towel Dispenser
Plastic - Wall Mounted

Part No.	Price
600 005	£37.90

Gasket Paper

PLASTIC WATER CONTAINERS



Plastic Water Containers
With Carry Handle
Tough & Durable

Part No.	Size	Price
969 005	5 litre	£6.35
969 025	25 litre	£13.25

GASKET PAPER



Gasket Paper
1 m² Sheets

Part No.	Size	Thickness	Price
425 129	1m x 1m	0.15mm	£2.70
425 130	1m x 1m	0.25mm	£3.90
425 131	1m x 1m	0.80mm	£9.02

NON STICK GASKET PAPER



Exhaust Paper
Non Asbestos with Integral
Non-Stick Finish
48" x 12" Sheets

Part No.	Size	Thickness	Price
425 127	48" x 12"	0.40mm	£16.65
425 128	48" x 12"	0.75mm	£24.16

CORK GASKET SHEET



Cork/Neoprene Gasket
Highly Compressible
For Low & Medium Bolt
Pressure Applications
Withstands Weather, Petrol,
Acid & Oil

Part No.	Width	Thickness	Length	Price
124 0157	1m	1.0mm	1m Sheet	£22.12
124 0158	1m	1.0mm	10m Roll	£152.10
124 0159	1m	1.5mm	1m Sheet	£25.48
124 0160	1m	1.5mm	10m Roll	£228.50
124 0161	1m	2.0mm	1m Sheet	£32.31
124 0162	1m	2.0mm	10m Roll	£280.80
124 0163	1m	3.0mm	1m Sheet	£47.28
124 0164	1m	3.0mm	10m Roll	£449.50

NEOPRENE RUBBER SHEET



Suitable for Water, Ozone,
Most Oils, Greases, Moderate
Acids & Chemicals
Temp Range: -20°C to 110°C

Part No.	Width	Thickness	Length	Price
124 0284	1.4m	1.5mm	1m Sheet	£27.40
124 0285	1.4m	1.5mm	10m Roll	£260.00
124 0286	1.4m	2.0mm	1m Sheet	£32.62
124 0287	1.4m	2.0mm	10m Roll	£260.00
124 0068	1m	3.0mm	1m Sheet	£26.34
124 0069	1m	3.0mm	10m Roll	£230.00

PAINT BRUSHES



High Quality Paint Brushes
Pure Bristles

Part No.	Size	Price
895 186	1/2"	£1.22
895 187	1"	£1.62
895 188	1.1/2"	£1.89
895 189	2"	£2.60
895 190	3"	£3.52
110 156	5 Assorted HQ Brushes Sizes 1/2" to 3"	£9.97

4" MASONRY BRUSH



Faithfull 100mm Masonry Brush
For Smooth Or Rough Surfaces
Ideal For Various Masonry Paints
Synthetic & Natural Bristle Mix

Part No.	Price
FAIPBMAS	£7.62

10 TOUCH-UP BRUSHES



10 High Quality Touch-Up
Paint Brushes
Wooden Handles
Sizes: No. 2, 4, 6, 8

Part No.	Price
110 114	£8.51

Paint Brushes

24 TOUCH-UP BRUSHES



24 Budget Touch-Up Paint Brushes
Plastic Handles
3 Sizes

Part No.	Price
110 173	£5.43

9" FOAM PAINT ROLLER



9" Paint Roller for General Decorating c/w Foam Refill

Part No.	Description	Price
200 979	9" Paint Roller	£3.85
200 980	Foam Refill	£1.48

9" FIBRE PAINT ROLLER

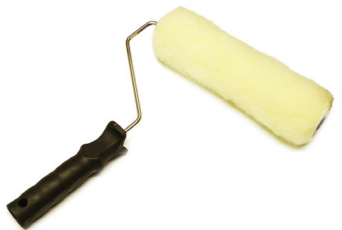

9" Paint Roller for General Decorating c/w Fibre Refill

Part No.	Description	Price
200 981	9" Paint Roller	£3.71
200 982	Fibre Refill	£1.95

9" PAINT ROLLER TRAY



9" Paint Roller Tray

Part No.	Price
200 983	£1.95

WALLPAPERING SCISSORS



High Quality Scissors
280mm Long

Part No.	Price
985 418	£12.86

4" GLOSS MINI ROLLER SET



4" Gloss Mini Roller Set
Includes Roller & Tray

Part No.	Description	Price
999 750	4" Gloss Roller Set	£4.67
999 751	10 x 4" Foam Refills	£7.95

DUST SHEETS



Washable Cotton & Polythene Dust Sheets

Ideal for Painters & Decorators

Part No.	Type	Size	Qty	Price
999 575	Cotton	3.5 x 2.6m	1	£13.25
999 580	Polythene	12ft x 9ft	3	£5.65

WINDOW SCRAPER



Moulded Plastic With Heavy Duty Blade And Blade Guard

Part No.	Description	Price
999 610	Window Scraper	£2.20
999 620	Pack of 5 Blades	£2.31

RUBBER SANDING BLOCK



5" Rubber Sanding Block
(sandpaper sold separately)

Part No.	Price
999 656	£5.10

Stencils

Custom Made Stencils

Examples:

Ideal for marking plant and machinery, doors, walls, vehicles, skips, ton bags, scaffolding etc. Use again and again.

Letter Height	Price per Letter
1"	£2.45
1.1/2"	£2.90
2"	£3.25
3"	£4.80
4"	£8.80



INTERLOCKING STENCIL SETS



Brass Interlocking Stencil Sets

Set Comprises:
- Letters A-Z
- Numerals 0-9
- Various Punctuation & Symbol Characters

INTERLOCKING LETTER SETS



A Interlocking Stencil Sets

Letter Set A-Z
(1 each per set)

Part No.	Letter Height	Material	Price
961 025	25mm	Brass	£19.02
961 050	50mm	Brass	£27.17
961 075	75mm	Brass	£40.79
961 100	100mm	ZP Steel	£64.62

Part No.	Letter Height	Pieces	Price
956 025	25mm	76	£51.13
957 025	25mm	100	£69.95
958 025	25mm	154	£105.90
956 050	50mm	76	£65.77
957 050	50mm	100	£87.20
958 050	50mm	154	£132.40
956 075	75mm	76	£93.40
957 075	75mm	100	£140.80
958 075	75mm	154	£199.50

INTERLOCKING NUMBER SETS



Interlocking Stencil Sets

Number Set 0-9
(1 each per set)

Part No.	Letter Height	Material	Price
959 025	25mm	Brass	£8.24
959 050	50mm	Brass	£11.78
959 075	75mm	Brass	£17.65
959 100	100mm	ZP Steel	£28.03

STENCIL SPRAY



Fast Drying, Waterproof

Stencil Spray
400ml Cans

MASKING TAPE



High Quality Masking Tape
50m Rolls

Part No.	Colour	Price
954 110	White	£10.15
954 100	Black	£9.99
954 105	Red	£6.77
954 111	Yellow	£10.05
954 112	Green	£10.55
954 113	Blue	£10.15

Part No.	Width	Price
895 336	25mm (1")	£1.19
895 337	50mm (2")	£1.95

Stencils

METAL LETTER SETS



Plain (not interlocking)
ZP Steel Stencil Sets

Letter Set A-Z
(1 each per set)

Part No.	Letter Height	Price
951 025	25mm	£16.36
951 050	50mm	£16.60
951 075	75mm	£29.00
951 100	100mm	£48.51

NUMBER PUNCH SETS



Set of 9 Number Punches
in Plastic Storage Case

Part No.	Number Height	Price
952 003	3mm	£9.47
952 006	6mm	£13.29
952 010	10mm	£28.48

METAL NUMBER SETS



Plain (not interlocking)
ZP Steel Stencil Sets

Number Set 0,1,2,3,4,5,
6,7,8 (for 9 use 6)

Part No.	Letter Height	Price
950 025	25mm	£6.10
950 050	50mm	£6.30
950 075	75mm	£11.04
950 100	100mm	£17.84

LETTER PUNCH SETS



Set of 27 Letter Punches
in Plastic Storage Case

(A-Z plus &)

Part No.	Number Height	Price
953 003	3mm	£22.80
953 006	6mm	£37.29
953 010	10mm	£79.30

WHITEBOARDS



Budget Dry Wipe Whiteboards
Ideal for use in Workshops,
Warehouses, Offices etc.

Made From 3mm PVC
Easily Cleaned Using a
Dry Cloth

Part No.	Size	Price
200 427	300mm x 200mm	£12.90
200 429	600mm x 400mm	£52.98

DRY WIPE PENS



Dry Wipe Marker Pens

1.3mm Bullet Point Nib

Part No.	Colour	Price
200 430	Black	£1.85
200 431	Blue	£1.85
200 432	Red	£1.85

NOTEBOOKS - 3 PACK



A5 & A4 Notepads
200 Pages Spiral Bound
Pack of 3

Part No.	Size	Price
199 001	A4 (3 pack)	£13.23
199 002	A5 (3 pack)	£7.20

HB PENCILS - 6 PACK



Rubber Tipped HB Pencils

Pack of 6

Part No.	Price
199 020	NLA

Spray Paints

Double Coverage Acrylic Spray Paints

Easy and convenient to apply
Double coverage
Can be used on plastics, metals & ceramics
150ml pack size (equivalent to 300ml)



Part No.	Colour	Size	Price
962 002	Grey Primer	150ml	£4.58
962 003	Satin Black	150ml	£4.58
962 004	Radiant Red	150ml	£4.58
962 005	Modena Green	150ml	£4.58
962 006	Signal Yellow	150ml	£4.40
962 007	Phoenix Orange	150ml	£4.58
962 008	Nissan Gold	150ml	£4.58
962 009	Moondust Silver	150ml	£4.58
962 011	Fiat White	150ml	£4.40
962 012	Pageant Mid Blue	150ml	£4.40

Part No.	Colour	Size	Price
963 051	Gloss Black	400ml	£4.35
963 050	Satin Black	400ml	£4.35
963 225	Gloss White	400ml	£4.75
963 052	Silver Grey VHT	400ml	£9.98
963 200	Post Office Van Red	400ml	£8.58
963 150	AA Van Yellow	400ml	£8.82
963 055	Blue VHT	400ml	£8.60
963 253	Green	400ml	£7.20
963 057	Clear Lacquer	400ml	£5.94

Standard Spray Paints

Excellent covering power, excellent durability
400ml pack size



FIXT Primers

Excellent covering properties, providing a highly durable base coat
400ml pack size



Part No.	Description	Size	Price
FX081226	Grey Primer	400ml	£5.18
FX081225	Zinc Galv Primer	400ml	£5.07
FX081227	White Primer	400ml	£5.18
FX081228	Aluminium Paint	400ml	£5.18
FX081233	Engine Lacquer	400ml	£5.18

Document Wallets

Plastic Wallets

Made from Anti-glare Clear Plastic - Open at One Edge

Protects Contents from the Effects of Frequent Handling, Grease, Dirt & Dust

PLASTIC WALLET WITH FLAP

Clear Plastic Wallet Sleeve Type with a 50mm Flap

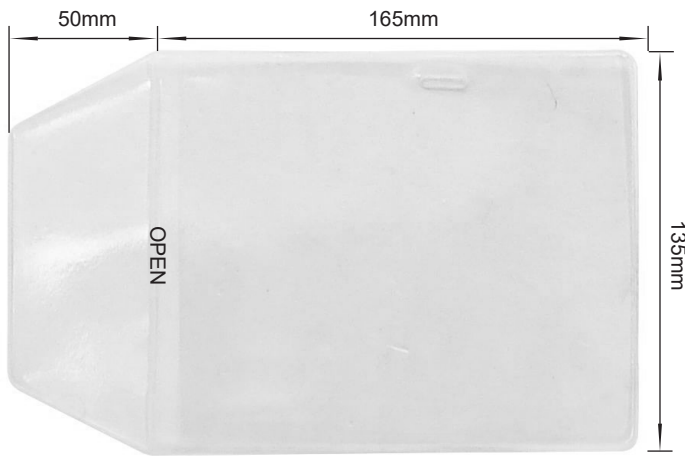

Part No.	Pack Size	Price
210 445	10 Pack	£3.50
250 445	50 Pack	£17.00
250 100	100 Pack	£33.50
250 500	500 Pack	£157.70

PLASTIC WALLET WITH EYELET

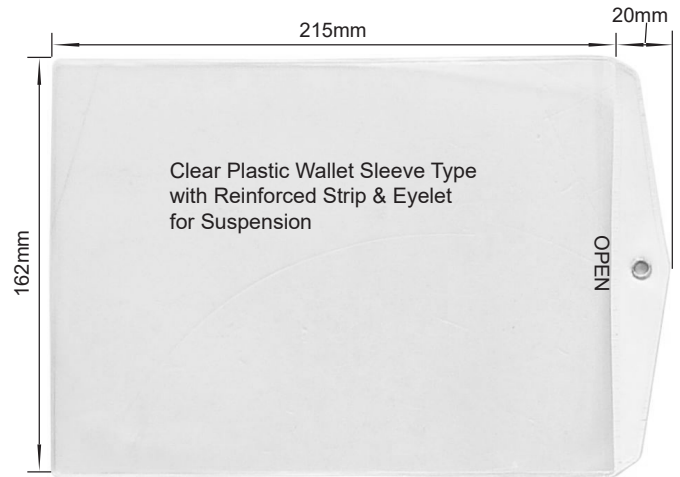

Part No.	Price
200 444	£0.95

100 PACK CABLE TIES

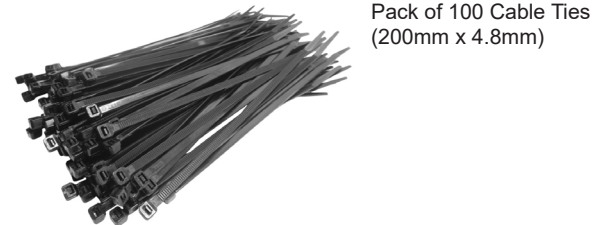

Part No.	Price
245 191	£2.67

A4 Plastic Document Holder. Can be attached to a vehicle via 2 pre drilled fixing holes or by using double sided tape. Can be locked using a small padlock.	Round Plastic Document Holder Tube Overall Length: 400mm Tube Length: 350mm 315mm Hole Centres for Fixing	Single Hole Metal Tie on Tag. Single hole for attachment using wire or small cable ties. Paper Faced - can be written on using a biro or marker	Double Slot Metal Tie on Tag. Double Slot for attachment using rope, strapping, wire or small cable ties. Paper Faced - can be written on using a biro or marker	Wire Ties 10" wire ties to suit single and double hole tie on tags Pack of 10
901 006	901 008	200 032	200 030	200 031
£18.57	£11.28	£0.49	£0.48	£0.32

Abrasives - Husqvarna Diamond Blades

Husqvarna Performance Grades

BRONZE Bronze category is ideal for occasional users. It offers ease of use combined with product quality, durability and affordability.

SILVER Silver category is ideal for general contractors and is developed for professional use in all-round applications. It offers high cutting speed and wear resistance in all cutting and sawing operations.

GOLD Gold category, the blades are developed for intensive professional use in specialist applications, providing maximum cutting speed and wear resistance in heavy cutting operations.

TACTI-CUT S50 DIAMOND BLADE



Husqvarna Tacti-Cut S50 Diamond Blade - For cutting concrete & abrasive building materials

BRONZE Husqvarna

Part No.	Size	Segment	Bore	Price
579 81 64 11	12" / 300mm	10mm	20mm	£27.03

TACTI-CUT S50+ BLADE



Husqvarna Tacti-Cut S50+ Diamond Blade - For cutting concrete & abrasive building materials

BRONZE Husqvarna

Part No.	Size	Segment	Bore	Price
579 81 56 11	12" / 300mm	13mm	20mm	£37.60
579 81 56 20	14" / 350mm	13mm	25.4mm	£62.37

TACTI-CUT S65 DIAMOND BLADE



Husqvarna Tacti-Cut S65 Diamond Blade - For cutting concrete & abrasive building materials

BRONZE Husqvarna

Part No.	Size	Segment	Bore	Price
579 81 65 10	12" / 300mm	10mm	25.4mm	£80.20
579 81 65 20	14" / 350mm	10mm	25.4mm	£93.70

TACTI-CUT S85 DIAMOND BLADE



Husqvarna Tacti-Cut S85 Diamond Blade - For cutting asphalt & abrasive building materials

BRONZE Husqvarna

Part No.	Size	Segment	Bore	Price
579 81 66 10	12" / 300mm	10mm	25.4mm	£75.12
579 81 66 20	14" / 350mm	10mm	25.4mm	£93.70

VARI-CUT S50 DIAMOND BLADE



Husqvarna Vari-Cut S50 Diamond Blade - For cutting concrete & abrasive building materials

SILVER Husqvarna

Part No.	Size	Segment	Bore	Price
586 59 55 11	12" / 300mm	10mm	20mm	£92.30
586 59 55 02	14" / 350mm	10mm	25.4mm	£113.90

VARI-CUT S65 DIAMOND BLADE

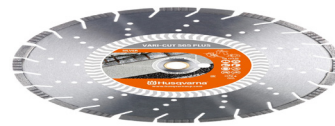

Husqvarna Vari-Cut S65 Diamond Blade - For cutting concrete & abrasive building materials

SILVER Husqvarna

Part No.	Size	Segment	Bore	Price
587 90 44 01	12" / 300mm	10mm	20mm	£90.90
587 90 45 01	14" / 350mm	10mm	25.4mm	£113.90
534 97 70 50	18" / 450mm	10mm	25.4mm	£168.70

VARI-CUT S85 DIAMOND BLADE



Husqvarna Vari-Cut S85 Diamond Blade - For cutting asphalt & abrasive building materials

SILVER Husqvarna

Part No.	Size	Segment	Bore	Price
579 81 77 11	12" / 300mm	10mm	20mm	£92.30
579 81 77 20	14" / 350mm	10mm	25.4mm	£113.90
579 80 96 50	18" / 450mm	10mm	25.4mm	£171.30

ELITE-CUT S35 DIAMOND BLADE



Husqvarna Elite-Cut S35 Diamond Blade - For cutting concrete & abrasive building materials

GOLD Husqvarna

Part No.	Size	Segment	Bore	Price
579 81 15 20	14" / 350mm	15mm	25.4mm	£154.20
579 82 06 50	18" / 450mm	15mm	25.4mm	£224.60

DIAMOND TILE BLADE

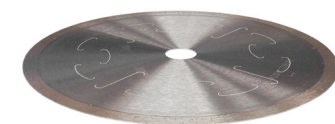

10" / 250mm, Arbor Dia 25.4mm
Continuous Rim for use with
Tile & Brick Saws

Husqvarna

Part No.	Price
543 08 06 16	£55.67

Abrasives

DEWALT DIAMOND TILE BLADE



DeWalt Diamond Tile Blades
Suitable for Wet and Dry Cutting
Continuous Rim, Suitable for all Tile
Materials



Part No.	Size	Bore	Price
DEWDT3714QZ	4 1/3" / 110mm	20mm	£33.88
DEWDT3733XJ	10" / 254mm	25.4mm	£80.47

BUDGET DIAMOND TILE BLADE



Budget Diamond Tile Blades
Suitable for Wet Cutting
Continuous Rim, Not Suitable for
Hard Tiles such as Porcelain and
Gres

Part No.	Size	Bore	Price
FAIDB105CRP	4 1/6" 105mm	16mm	£13.85
FAIDB115CR	4 1/2" 115mm	22.2mm	NLA
FAIDB180CR	7 1/10" 180mm	25.4mm	£17.98

TRADE DIAMOND BLADES



Entry Level Blade 10mm Segment
General Construction Materials
Concrete, Brick, Natural Stone, Tiles



Part No.	Size	Bore	Price
300 605	4 1/2" / 115mm	22mm	£5.87
300 609	9" / 230mm	22mm	£18.36
333 002	12" / 300mm	20mm	£23.00

TURBO DIAMOND BLADES



Pro 10mm Angled Turbo Segment
General Construction Materials
Concrete with Steel, Brick, Natural
Stone, Tiles



Part No.	Size	Bore	Price
300 604	4 1/2" / 115mm	22mm	£7.10
333 020	12" / 300mm	20mm	£36.72

EXPERT DIAMOND BLADE



Expert 10mm Continuous Segment
General Construction Materials
Long Life/Fast Cut Blade Concrete
with Steel, Brick, Natural
Stone, Tiles



Part No.	Size	Bore	Price
333 030	12" / 300mm	20mm	£75.58

CLIPPER CLASSIC UNI

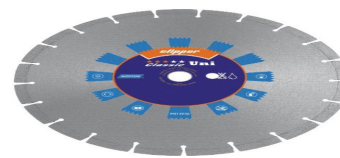

Norton Clipper Classic UNI
General Construction Materials
Concrete, Brick, Natural Stone, Tiles



Part No.	Size	Bore	Price
70184626807	5" / 125mm	22mm	£13.89
70184626810	9" / 230mm	22mm	£32.18
70184626811	12" / 300mm	20mm	£60.11
70184626813	14" / 350mm	25.4mm	£74.19

CLIPPER CLASSIC BETON



Norton Clipper Classic Beton
For cutting concrete, reinforced
concrete & hard building materials



Part No.	Size	Bore	Price
70184626869	12" / 300mm	20mm	£80.50
70184626872	14" / 350mm	25.4mm	£112.20
70184626873	16" / 400mm	25.4mm	£144.30
70184626874	18" / 450mm	25.4mm	£153.70

CLIPPER CLASSIC ASPHALT



Norton Clipper Classic Asphalt
For cutting asphalt & abrasive
building materials



Part No.	Size	Bore	Price
70184626876	12" / 300mm	20mm	£100.70
70184626879	14" / 350mm	25.4mm	£155.60
70184626880	16" / 400mm	25.4mm	£160.30
70184626881	18" / 450mm	25.4mm	£249.70

4X4 EXPLORER MULTIPURPOSE



Norton Clipper 4x4 Explorer
Long-life, multi-purpose blade for
cutting most construction materials
including concrete, reinforced
concrete granite, sandstone,
asphalt & steel up to 5mm



Part No.	Size	Bore	Price
70184625308	5" / 125mm	22mm	£44.20
70184646156	9" / 230mm	22mm	£86.10
70184646881	12" / 300mm	20mm	£154.80
70184646571	14" / 350mm	20mm	£251.40
70184646154	14" / 350mm	25.4mm	£251.40
70184647348	16" / 400mm	25.4mm	£305.60
70184647349	18" / 450mm	25.4mm	£392.80

Abrasives

STONE CUTTING DISCS - FLAT

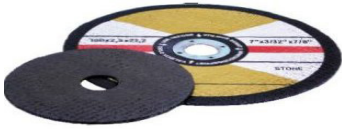

Abrasive Stone Cutting Discs
Flat Type

Suitable for a Wide Range of Stone
Cutting Applications

Part No.	Size	Hole Ø	Price (ea)
750 000	4" (100mm)	16mm	£1.24
750 003	4½" (115mm)	22mm	£1.45
750 005	5" (125mm)	22mm	£1.47
750 007	7" (178mm)	22mm	£1.94
750 009	9" (230mm)	22mm	£2.65
750 011	12" (300mm)	20mm	£3.22
750 013	12" (300mm)	22mm	£2.98
750 015	14" (350mm)	25.4mm	£4.90

METAL CUTTING DISCS - DPC



Abrasive Metal Cutting Discs
Depressed Centre

Suitable for a Wide Range of
Metal Cutting Applications

Part No.	Size	Hole Ø	Price (ea)
750 019	4" (100mm)	16mm	£1.43
750 021	4½" (115mm)	22mm	£1.40
750 023	5" (125mm)	22mm	£1.56
750 025	7" (178mm)	22mm	£1.86
750 027	9" (230mm)	22mm	£3.04

STONE CUTTING DISCS - DPC



Abrasive Stone Cutting Discs
Depressed Centre

Suitable for a Wide Range of Stone
Cutting Applications

Part No.	Size	Hole Ø	Price (ea)
750 018	4" (100mm)	16mm	£1.34
750 020	4½" (115mm)	22mm	£1.46
750 022	5" (125mm)	22mm	£1.59
750 024	7" (178mm)	22mm	£1.83
750 026	9" (230mm)	22mm	£2.67

METAL GRINDING DISCS - DPC



Abrasive Metal Grinding Discs
Depressed Centre

Suitable for a Wide Range of
Metal Grinding Applications

Part No.	Size	Hole Ø	Price (ea)
750 029	4" (100mm)	16mm	£1.59
750 031	4½" (115mm)	22mm	£1.78
750 033	5" (125mm)	22mm	£2.51
750 035	7" (178mm)	22mm	£2.60
750 037	9" (230mm)	22mm	£3.93

STONE GRINDING DISCS - DPC



Abrasive Stone Grinding Discs
Depressed Centre

Suitable for a Wide Range of Stone
Grinding Applications

Part No.	Size	Hole Ø	Price (ea)
750 028	4" (100mm)	16mm	£1.48
750 030	4½" (115mm)	22mm	£1.68
750 032	5" (125mm)	22mm	£2.15
750 034	7" (178mm)	22mm	£2.65
750 036	9" (230mm)	22mm	£5.07

THIN METAL CUTTING DISCS



Extra Thin Metal Cutting Disc
Suitable for Metal & Stainless
Steel Cutting Applications

22mm Bore

Part No.	Size	Thickness	Price (ea)
750 076	4.1/2"	0.75mm	£1.35
750 040	4.1/2"	1mm	£1.10
750 043	4.1/2" (10pk)	1mm	£8.67
750 045	5"	1mm	£2.00

METAL CUTTING DISCS - FLAT

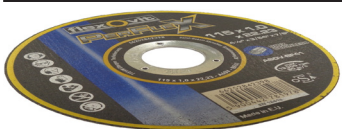

Abrasive Metal Cutting Discs
Flat Type

Suitable for a Wide Range of
Metal Cutting Applications

Part No.	Size	Hole Ø	Price (ea)
750 002	4" (100mm)	16mm	£1.43
750 004	4½" (115mm)	22mm	£1.43
750 006	5" (125mm)	22mm	£1.56
750 008	7" (178mm)	22mm	£2.02
750 010	9" (230mm)	22mm	£2.65
750 012	12" (300mm)	20mm	£3.49
750 014	12" (300mm)	22mm	£3.19
835 326	12" (300mm)	25.4mm	£3.09
750 050	14" (350mm)	20mm	£9.74
750 016	14" (350mm)	25.4mm	£6.28

4½" FLAP DISCS



Zirconium Flap Discs
Depressed Centre

115mm x 22mm Hole

Part No.	Grade	Price (ea)
969 251	80 Grit (medium)	£2.69
969 252	40 Grit (coarse)	£2.69

Abrasives

115MM POLISHING DISC



Polishing Disc
Removes Rust & Paint

115mm Dia x 22mm Bore

Part No.	Price
750 310	£8.64

5" CUP STONES



Ideal for General Grinding & Surface Preparation

M14 Thread

Part No.	Application	Price
891 100	Concrete & Stone	£17.27
891 102	Metal	£16.90

PEG SPANNERS



Colour Coded Peg Spanners

For Fitting or Removing
Abrasive Discs

Part No.	Colour	Peg Centres	Peg Ø	Price
300 260	Red	35mm	5mm	£3.50
300 100	Zinc (fork)	35mm	5mm	£3.55
300 170	Green	20mm	4mm	£3.62
300 210	White	30mm	4mm	£3.12
300 200	Yellow	28mm	4mm	£3.50
300 230	Black	32mm	5mm	£4.38

200MM BENCH WHEELS - ALOX

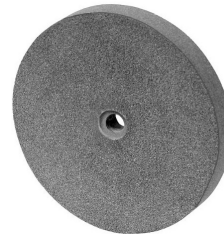

200mm Aluminium Oxide
Wheels for General Grinding

32mm Bore with Reducing
Rings to suit 25mm, 20mm &
16mm Bore Grinders

Part No.	Material	Grade	Price
800 820	Aluminium Oxide	36 Grit	£35.73
800 825	Aluminium Oxide	80 Grit	£35.73
800 830	Aluminium Oxide	120 Grit	£35.73

ADJUSTABLE PEG SPANNER



For Fitting or Removing
Abrasive Discs

Range 20-35mm
Suits Pins 3-5mm

Part No.	Price
300 120	£27.50

200MM BENCH WHEEL - SIC



200mm Silicon Carbide Wheel
for Sharpening Tungsten
Carbide Tools

32mm Bore with Reducing
Rings to suit 25mm, 20mm &
16mm Bore Grinders

Part No.	Material	Grade	Price
800 855	Silicon Carbide	80 Grit	£25.74

BACKING SPANNER



Angle Grinder Backing
Spanner
14mm/17mm

Part No.	Price
300 110	£3.53

150MM BENCH WHEELS - ALOX



150mm Aluminium Oxide
Wheels for General Grinding

32mm Bore with 13mm
Reducing Bush

Part No.	Thickness	Grade	Price
895 366	13mm	36 Grit	£14.78
895 367	13mm	80 Grit	£14.72
895 368	16mm	36 Grit	£15.27
895 369	16mm	80 Grit	£15.27

M14 BLADE FLANGE



Replacement Blade Flange

Suitable for most M14
threaded angle grinders

Part No.	Price
300 270	£1.71

Abrasives

150MM BENCH WHEEL - SIC



150mm Silicon Carbide
Wheel for Sharpening Tungsten
Carbide Tools

32mm Bore with 13mm
Reducing Bush

Part No.	Material	Grade	Price
895 370	Silicon Carbide	80 Grit	£18.26

CUP BRUSHES



Twisted Wire Cup Brushes
0.35mm Oil Hardened Steel Wire
Max 8500 rpm

Ideal for Polishing & Surface
Preparation

Part No.	Diam.	Thread	Price
891 115	3"	M10	£10.19
891 111	4"	M14	£16.32
891 113	5"	M14	£21.13

CUP BRUSHES



Crimped Wire Cup Brushes
0.30mm Crimped Steel Wire
Max 8500 rpm

Ideal for Polishing & Surface
Preparation

Part No.	Diam.	Thread	Price
891 114	3"	M10	£6.20
891 110	4"	M14	£12.19
891 112	5"	M14	£15.74

200MM BENCH GRINDER BRUSH



200mm x 25mm Wide All
Purpose Wire Wheel
32mm Bore with Reducing
Rings to suit 25mm, 20mm,
16mm & 13mm Bore Grinders

Part No.	Price
800 865	£16.88

150MM BENCH GRINDER BRUSH



150mm Wire Wheel For
Bench Grinders

38mm Bore with Metric &
Imperial Adaptors

Part No.	Price
895 375	£15.02

WHEEL DRESSERS



Designed For Dressing, Truing,
Sharpening And Removing
Glaze From Solid Abrasive
Grinding Wheels

Part No.	Description	Suits	Price
816 700	Wheel Dresser No.1	6" Wheels	£29.00
816 705	Wheel Dresser No.2	8" Wheels	£76.89
816 710	Spare Cutter No.1	6" Wheels	£6.36
816 715	Spare Cutter No.2	8" Wheels	£10.60

CUP BRUSH - 9MM SHANK



Crimped Steel Wire Cup Brush
For Use With Power Drills

Max 4,500rpm
50mm Diameter
9mm Shank

Part No.	Price
895 382	£3.33

5 PIECE STONE GRINDING SET



Drill Mounted Rotary Grinding
Stones Suitable For Use On
Most Metals

6mm Shank

Part No.	Price
969 253	£2.95

CIRCULAR BRUSH - 9MM SHANK



Crimped Steel Wire
Circular Brush
For Use With Power Drills

Max 4,500rpm
50mm Diameter
9mm Shank

Part No.	Price
895 377	£2.17

Abrasives

3 PIECE WIRE BRUSH SET



50mm Wire Cup Brush, 50mm Wire Wheel & 25mm End Brush For Use With Power Drills

6mm Shank

Part No.	Price
969 254	£3.42

FLAP WHEELS

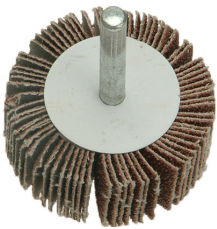

For Use In Drills & Flexible Shaft Drives
Aluminium Oxide Grain

60 Grit, 6mm Shank

Part No.	Diam.	Height	Price
969 250	50mm	20mm	£2.85
969 284	60mm	30mm	£3.75
969 450	80mm	30mm	£4.35

NYLON BACKING PADS



Nylon Backing Pads
(Max 13,000rpm)

Part No.	Diam.	Thread	Price
895 361	4"	M10 x 1.25	NLA
300 201	4"	M10 x 1.5	£5.80
300 302	4½"	M14 x 2	£6.00
300 303	5"	M14 x 2	£6.60
300 304	7"	M14 x 2	£12.87

DELTA SHAPED SANDING PADS



Delta Shaped Hook & Loop Sanding Pads
Aluminium Oxide Grain

93mm x 93mm

Part No.	Grade	Price (ea)
939 080	80 Grit	£0.38
939 180	180 Grit	£0.38

SANDING DISCS S/ADHESIVE



Backed with Pressure Sensitive Adhesive

Diameter: 150mm (6")

Part No.	Diam.	Grade	Price (ea)
835 651	6"	320 Grit	£0.36
835 652	6"	180 Grit	£0.36
835 653	6"	120 Grit	£0.36
835 654	6"	80 Grit	£0.36
835 655	6"	60 Grit	£0.40
835 656	6"	40 Grit	£0.36

SANDING DISCS - HOOK & LOOP



Aluminium Oxide with Dust Extraction Holes

Hook & Loop Backing

Part No.	Diam.	Grade	Price (ea)
835 661	6"	220 Grit	£1.40
835 662	6"	180 Grit	£1.40
835 663	6"	120 Grit	£1.40
835 664	6"	100 Grit	£1.40
835 665	6"	80 Grit	£1.40
835 666	6"	60 Grit	£1.40
835 667	6"	40 Grit	£1.40

SANDING DISCS - FIBRE



Aluminium Oxide Fibre Backed

Part No.	Diam.	Grade	Price (ea)
538 001	4"	36 Grit	£0.52
538 005	4"	60 Grit	£0.44
538 010	4"	100 Grit	£1.13
538 015	4½"	36 Grit	£0.67
538 020	4½"	60 Grit	£0.52
538 025	4½"	100 Grit	£0.57
538 029	7"	40 Grit	£1.37
538 030	7"	60 Grit	£1.04
538 035	7"	100 Grit	£1.11

Abrasives

3" SANDING BELTS



Aluminium Oxide, Highest Quality Full Resin Cloth Belt

553 x 75mm (22" x 3")

Part No.	Grade	Price (ea)
538 056	36 Grit	£2.33
538 057	60 Grit	£2.10
538 058	100 Grit	£2.37

4" SANDING BELTS



Aluminium Oxide, Highest Quality Full Resin Cloth Belt

610 x 100mm (24" x 4")

Part No.	Grade	Price (ea)
538 040	36 Grit	£2.43
538 045	60 Grit	£2.43
538 050	100 Grit	£2.26

FLOOR SANDER SHEETS

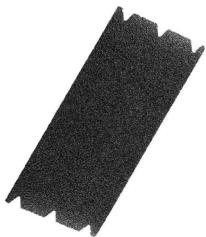

Industrial quality Floor Sander Sheets for rapid sanding and finishing of all types of wooden floor

205mm x 478mm

Part No.	Grade	Price (ea)
538 060	24 Grit	£1.33
538 061	40 Grit	£1.31
538 062	60 Grit	£1.14
538 063	80 Grit	£1.04
538 064	120 Grit	£0.95

EMERY ROLLS



Blue Twill Cloth, Aluminium Oxide Grain

25mm Wide x 50m Roll

Part No.	Grade	Price (ea)
835 157	40 Grit	£18.27
835 156	80 Grit	£15.72
835 155	120 Grit	£14.58

EMERY SHEETS

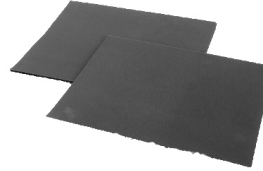

Blue Twill Cloth, Aluminium Oxide Grain

230 (9") x 280mm (11")

Part No.	Grade	Price (ea)
835 160	40 Grit	£0.76
835 159	80 Grit	£0.74
835 158	120 Grit	£0.74

SANDPAPER SHEETS



Sandpaper Sanding Sheets

230 (9") x 280mm (11")

Part No.	Grade	Price (ea)
835 170	40 Grit	£0.48
835 171	80 Grit	£0.57
835 172	120 Grit	£0.54

WET & DRY PAPER

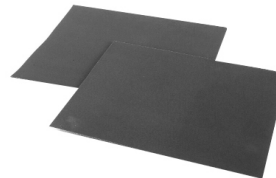

Waterproof Alum Oxide Grain For Wood, Paint, Metal & Automotive Use

230 (9") x 280mm (11")

Part No.	Grade	Price (ea)
835 141	120 Grit	£0.48
835 147	220 Grit	£0.48
835 144	400 Grit	£0.48
835 145	600 Grit	£0.48

SANDING SPONGES

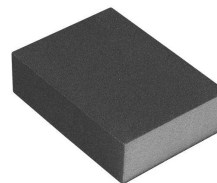

Sanding Sponge Blocks Use Wet or Dry

100mm x 70mm x 25mm

Part No.	Grade	Price
835 175	40 Grit	£1.20
835 176	80 Grit	£1.20
835 177	100 Grit	£1.44

RUBBER SANDING BLOCK



Rubber Sanding Block

Length: 125mm

Part No.	Price
999 656	£5.10

Numatic Vacuum Spares

GENUINE NUMATIC DUST BAGS



Hepaflo 3 Layer Filter Dust Bags
fits Numatic Vacuum Cleaners
Dust Bags 10 Pack

Part No	Price
908 0124	NLA

PAPER HENRY VACUUM BAG



Replacement Henry Vacuum
Bag. Tough Paper Bag
Complete with Cardboard Collar

Part No	Price (ea)
299 900	£0.93

DUST BAGS 10 PACK



Filter-Flo Synthetic Vacuum
Dust Bags 10 Pack

Part No	Price
908 0015	£7.56

FILTERED DUST BAGS 10 PACK



Filter-Flo Synthetic Vacuum
5 Layer Filtration
Dust Bags 10 Pack

Part No	Price
908 0016	£9.77

CLOTH FILTER BAG



White Cloth Filter Bag for
Numatic Henry Hoover Vacuum
Replaces: NVM-15B

Part No	Price
713 302	£10.77

THREADED BAG CONNECTOR



Red Threaded Bag Connector
for Numatic Henry Hoover
Vacuum

Part No	Price
713 314	£11.70

BAG CONNECTOR



Bag Connector for Numatic
'Henry' Hoover Vacuum Cleaner

Part No	Price
713 312	£15.06

VACUUM HOSES

12/SBK



908 0283

Vacuum Hose 32mm Dia fitted
with cuffs suitable for Numatic
vacuum cleaners



908 0183

Part No	Type	Price
908 0283	1.8m Domestic & Commercial	£11.19
908 0183	Slanted Cuffs c/w Adaptor 5m	£11.99
908 0298	Genuine Numatic 2.4m	£33.17

SIDE HOSE END CONNECTOR



Side Hose End Connector 32mm
fits Henry Numatic Cylinder
Vacuum Cleaners

Part No	Price
908 0358	£3.50

CHROME HOSE BEND END



Chrome Hose Bend End 32mm
Dia c/w Reducer fits Henry/
Hetty Numatic Vacuum Cleaners

Part No	Price
908 0173	£6.78

Numatic Vacuum Spares

EASY RIDE AIRO BRUSH



Easy Ride Airo Brush Nozzel
Head 32mm fits Henry Numatic
Vacuum Cleaners
Genuine Numatic Part

Part No	Price
908 0190	£84.42

WET/DRY FLOOR ATTACHMENT



Replacement 38mm Wet/Dry
Floor Attachment
fits 'Henry', 'Hetty', 'Edward' and
'James' vacuum cleaners

Part No	Price
713 267	£32.97

COMBINATION HEAD TOOL



Suitable for Numatic Vacuum
Cleaners. HI-PRO Hp290,
Wand Dock Elbow c/w Wand
Dockclip. Genuine Numatic.

Part No	Price
908 0001	£65.05

HEAD TOOL LONG ELBOW



Long Elbow Combination Floor
Tool. Suitable for all Henry, Harry
and Hetty models

Part No	Price
908 0310	£67.88

TOP LIFTING HANDLE



Top Lifting Handle for Numatic
'Henry' Hoover Vacuum Cleaner

Part No	Price
713 301	£21.20

BUCKET CLIP CONNECTOR



Bucket Clip Connector for
Numatic 'Henry' Hoover
Vacuum Cleaner

Part No	Price
713 315	£6.02

FRONT CASTOR WHEEL



Front Castor Wheel for Numatic
'Henry' Hoover Vacuum Cleaner

Part No	Price
713 308	£21.92

TWIN CASTOR/RUNNER WHEEL



Twin Castor/Runner Wheel long
shaft fits Numatic Henry Cylinder
Vacuum Cleaners
Genuine Numatic Part.

Part No	Price
908 0439	£9.35

REAR WHEEL FOR NUMATIC



Rear Wheel for Numatic 'Henry'
Hoover Vacuum Cleaner

Part No	Price
713 310	£18.87

HUB FOR REAR WHEEL



Hub for Rear Wheel fits Numatic
'Henry' Hoover Vacuum Cleaner

Part No	Price
713 311	£5.07

REAR WHEEL COVER



Rear Wheel Cover for Numatic
'Henry' Hoover Vacuum Cleaner

Part No	Price
713 317	£8.03

3" CASTOR WHEEL



Castor Wheel (each)
For Numatic Wet and Dry Vacuum
Cleaners Suitable for the WV900

Part No	Price
510 975	£12.37

Numatic Vacuum Spares

10M - 3 CORE CABLE & PLUG



1mm 3-Core Cable & Plug
Fits Numatic/Henry Vacuums
Sold as 10 Metre Roll

Part No	Price
713 306	£52.08

12M - 2 CORE CABLE & PLUG



Mains Power Cable 12m - 2 core
1.0mm Fitted UK 13Amp Plug
fits Numatic Vacuum Cleaners

Part No	Price
908 0377	£13.72

CABLE HOOK BLACK



Vacuum Cleaner Cable Hook
Genuine Numatic Part

Part No	Price
908 0725	£11.41

STRESS RELIEF SHROUD



Cable Stress Relief Shroud.
Genuine Numatic Part

Part No	Price
908 0501	£3.13

HI/LO GREEN ROCKER SWITCH



Green Rocker Hi/Lo Switch fits
Numatic Cylinder Vacuum
Cleaners. Genuine Numatic Part

Part No	Price
908 0502	£26.76

RED ROCKER ON/OFF SWITCH



Red Rocker On/Off Switch fits
Numatic Cylinder Vacuum
Cleaners. Genuine Numatic Part

Part No	Price
908 0557	£27.77

GREEN ROCKER SWITCH



Green Rocker Switch for
Numatic 'Henry' Hoover
Vacuum Cleaner

Part No	Price
713 305	£17.65

RED HI/LOW ROCKER SWITCH



Red Hi/Low Rocker Switch for
Numatic 'Henry' Hoover
Vacuum Cleaner

Part No	Price
713 307	£31.19

DOUBLE POLE ON/OFF SWITCH

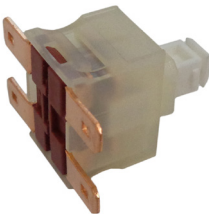

Double Pole On/Off Switch
Suitable for Numatic Domestic
Vacuum Cleaner Appliances
Genuine Numatic Part

Part No	Price
908 0379	£12.32

ON/OFF POWER SWITCH HVR2

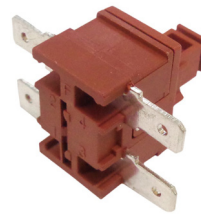

Double Pole On/Off Power
Switch HVR2 fits Henry/Hetty
Numatic Vacuum Cleaners

Part No	Price
908 0649	£3.75

SWITCH COVER PLUG HANDLE



Vacuum Cleaner Switch cover
plug handle. Genuine Numatic

Part No	Price
908 0398	£3.20

VACUUM SWITCH SPRING



Vacuum Cleaner Switch spring.
Genuine Numatic Part

Part No	Price
908 0654	£3.18

Abrasives

WIRE BRUSHES



Wire Brushes
Wooden Handle

Part No.	Bristles	Price
902 2025	2 Row	£1.96
902 2026	4 Row	£1.45

BRASS COATED WIRE BRUSHES



Brass Coated Steel Wire
Ergonomic Handle

Part No.	Price
800 880	£2.52

ASSORTED BRUSH SET



Assorted Abrasive Brush
Set with Nylon, Brass &
Wire Bristles

Part No.	Price
902 2029	£3.71

STEEL WOOL



Assorted Pack of 15 Pads
Fine, Medium & Coarse
Grades

Part No.	Price
895 294	£13.52

FLOOR SANDER DUST BAGS



Paper Dust Bags for HireTech
Floor Sanders

Part No.	Model	Price (ea)
299 977	HT7 Edging Sander	£1.35
299 978	HT8 Upright Sander	£1.25

DUSTBAG - HENRY VACUUMS



Henry Vacuum Bags
Suits all Standard Sized
Henry Vacuum Cleaners

Part No.	Price (ea)
299 900	£0.93

HOSE - HENRY VACUUMS



Suction Hose for
Henry Vacuum Cleaners
Complete with Fittings

Part No.	Type	Size	Price
713 250	Black	2.5m	£13.27
713 251	Yellow (hi-vis)	5m	£28.00

FLOOR ATTACHMENT



Floor Attachment for Henry
Vacuum Cleaners
For Carpet & Hard Floor

Part No.	Price
713 260	£11.80

CREVIS TOOL



Crevis Tool for Henry Vacuums
32mm Dia. Fitting
Overall length 10"

Part No.	Price
713 255	£1.85

VACUUM ACCESSORY KITS



Replacement Hose & Tool Kits

Includes 2.5mm hose, aluminium poles and floor tools

Henry kit pictured (Contents vary)

Part No.	Fits Models	Price
713 261	Henry Range (32mm)	£25.98
713 262	Numatic Wet & Dry Vacs (38mm)	£70.67
713 263	Karcher Wet & Dry Vacs (38mm)	£126.70
713 264	Niifisk/Alto Wet & Dry Vacs (38mm)	£84.80

SIP Air Compressors & Air Tools



Direct Drive Air Compressors

The Airmate Direct Drive Air Compressors have a Cast Iron Barrel for Longer Service Life, they have an Efficient and Durable Cooling System Suitable for most Trade Applications. Premium Italian Design.



Part No.	Description	Motor	Air Receiver	Max Pressure	Price
845 6238	SIP TN2.5/25-D	2.5 hp	25 Litre	116.0psi (8.0 Bar)	NLA
845 6242	SIP TN3/50-D	3.0 hp	50 Litre	130.0psi (9.0 bar)	£327.10
845 5299	SIP TN3/100-D	3.0 hp	100 Litre	130.0psi (9.0 bar)	£436.00

VERTICAL AIR COMPRESSOR



Airmate Hurricane Air Compressors have been Designed to give a Vertical Space-saving Construction with a Solid Top-mounted Control Panel and an Integrated Easy-to-read Gauge. They also Feature an Easy Drain Valve and Regulator.

These Vertical Air Compressors have a Solid and Durable Construction due to SIP's Premium Italian Design.

116.0psi (8.0 bar) Max Pressure



Part No.	Description	Motor	Air Rec.	Price
845 6249	SIP V215/25	1.5 hp	24 Litre	£185.40
845 6243	SIP V245/50	2.0 hp	50 Litre	£246.90
845 6245	SIP V300/100	2.5 hp	100 Litre	£418.00

PROFESSIONAL AIR NIBBLER



Cuts 1.2mm Sheet Metal
2,500 Strokes/min

1/4" BSP



Part No.	Price
845 7584	£61.50

1/2" AIR IMPACT WRENCH



Twin Hammer 7,500rpm Speed
1/4" BSP Air Inlet



Part No.	Price
845 7212	£105.20

3/4" AIR IMPACT WRENCH



7000 rpm
3/8" BSP inlet
Twin Hammer



Part No.	Price
845 7202	£212.10

AIR DRILL KEYLESS CHUCK



Operating Pressure 90psi (6.3 bar)
Advanced Composite Construction
Variable Speed Trigger for Control
Inlet 1/4" BSP



Part No.	Description	Speed	Price
845 7209	3/8" Keyless Drill	1800 rpm	£53.20
845 7208	1/2" Keyless Drill	700 rpm	£68.74

SWIVEL AIR HOSE REEL



360° Degree Unlimited Rotary Base
2.0 Metre Hose Connection Length
218.0psi (15.0 bar) Pressure
30. Metre Max. Hose Length
1/4" BSP Male Air Inlet
8.0mm Hose Diameter

Part No.	Price
845 7979	£115.40



We are an Authorised Distributor of SIP Industrial Products. SIP Industrial have been Designing and Manufacturing the Highest Quality Welding and Compressed Air Technology Since 1968.

Please See our Website for Special Offers and Promotions - www.lsengineers.co.uk

SIP Air Compressors & Air Tools

Retractable Air Hose Reels



The Air Hose Reel Boasts High Visibility, Heavy-duty PVC Hose in a Tough Plastic Reel and a Through Flow Function - Allowing to Pass Through, Meaning it can be (un)wound During Operation.



Part No.	Description	Pressure	Length	Hose Dia	Price
845 7972	Hose Reel 12	116 psi (8.0 bar)	12 metre	6.5mm	£99.80
845 7974	SIP TN3/50-D	145 psi (10 bar)	15 metre	9.5mm	£136.60
845 7976	SIP TN3/100-D	145 psi (10 bar)	30 metre	9.5mm	£224.90

1/4" AIR DIE GRINDER KIT 15PC



Supplied with set of grinding points, chuck spanners and carry-case
Straight-Midi Configuration
Ø3mm, Ø6mm Collet Size
High 22,000.0 rpm
7 cfm Air Consumption
90psi (6.3 bar) Operating Pressure
1/4" BSP Air Inlet

Part No.	Price
SEAGSA67	£51.95

HEAVY DUTY AIR HAMMER KIT



c/w 5 Chisels
190mm Air Hammer:
90.0psi (6.3 bar) Pressure.
4,500 Blows per/min Speed.
Low 3.0CFM Air Consumption.
Front-facing Exhaust.
1/4" BSP Air Inlet.
Compact and Lightweight Design.
Solid and Durable Construction.



Part No.	Price
845 6724	NLA

COBALT SPRAY GUN



1.4mm nozzle
7CFM (198ltr/min) average working air consumption
43psi (3bar) - 58psi (4bar) max. operating pressure
1/4" BSP Air Inlet



Part No.	Price
845 2131	£37.95

MIRAGE HVLP SPRAY GUN



1.8mm Dia
14.7CFM low Air Consumption
36.0 - 50.0psi (2.5 - 3.5 bar)
1/4" BSP Air Inlet



Part No.	Price
845 2136	£52.40

AIR DUSTER GUN



Operating Pressure 58psi (2-4 bar)
Air Inlet 1/4" BSP (male)



Part No.	Nozzle Length	Price
845 2146	100mm	£5.50
845 2147	300mm	£11.78

COMPACT AIR DUSTER GUN



c/w 50mm Nozzle

General Purpose Air Duster Gun
Compact Design
29.0 - 87.0psi (2-4 bar)
Operating Pressure
1/4" BSP Air Inlet



Part No.	Price
845 2139	£6.75



We are an Authorised Distributor of SIP Industrial Products. SIP Industrial have been Designing and Manufacturing the Highest Quality Welding and Compressed Air Technology Since 1968.

Please See our Website for Special Offers and Promotions - www.lsengineers.co.uk

SIP Welding Products



ARC Inverter Welders

EMC Filter Included, Generator Friendly, Exceptionally Compact and Lightweight
Reliable Thermal Overload Protection, Robust on-demand Fan Cooling,
Built-in Scratch TIG Function, Supplied with the Following:
Electrode Lead, Earth Lead.



Part No.	Description	Supply	Current Range	Price
845 5705	T1400 ARC Inverter	230v (13 amp)	10 - 140 amps	£214.10
845 5707	T1600 ARC Inverter	230v (16 amp)	10 - 160 amps	£245.00

MIG Gas/Gasless Transformer Welders

Ready to use in Gasless Mode, Thermal Overload Protection, Supplied with the Following:
1.8m MIG Torch, Earth Lead, Wire Brush, Handheld Shield, Contact tip, 0.2kg Flux and
Gas Bottle Brackets



Part No.	Description	Out Put Setting	Supply	Current Range	Price
845 5710	T126-MIG Gasless	2	230v (13 amp)	60 - 125 amps (peak)	£225.70
845 5736	T136-MIG Gas/Gasless	4	230v (13 amp)	30 - 135 amps (peak)	£281.10
845 5756	T166-MIG Gas/Gasless	6	230v (16 amp)	30 - 165 amps (peak)	£343.40

ARC/TIG INVERTER WELDERS

845 5711



845 5732



These ARC/TIG Inverters from SIP are Equipped with a
Voltage Reduction Device, Lift-TIG Start Function,
Anti-stick Circuitry and Dinse Sockets.



Part No.	Description	Price
845 5711	HG1400DA - 230v (13amp)	£298.20
845 5716	HG1600DV - 230v (16 amp)	£304.70
845 5715	HG2000DA - 230v (20 amp)	£399.00
845 5732	HG2600A - 230v (22 amp)	£402.00

3 TIER WELDING CART (ONLY)



The Three Tier Welding Cart is Perfect for Hosting a
Range of Premium Welding Machines, as well as a
Host of Accessories, Consumables and Gas Bottles.



Part No.	Price
845 5700	£81.94



We are an Authorised Distributor of SIP Industrial Products. SIP Industrial have been Designing and Manufacturing the
Highest Quality Welding and Compressed Air Technology Since 1968.

Please See our Website for Special Offers and Promotions - www.lengineers.co.uk

SIP Welding Products

Electronic Welding Headshields

- Premium Quality, Solar Powered Helmet.
Filter Darkens Instantly when the Arc is Struck.
- Fibreglass Reinforced Resin Construction
 - Light Weight
 - Improved Mechanism Simplifies Cassette Changing
 - Ergonomic Headband with Replaceable Brow
 - Band & Locking Ratchet Adjustment
 - Conforms to DIN, GS CE & EN 379 Spec
 - Dark Shade 11/ Light Shade 4
 - Darkening time less than 0.2 Sec
 - UV/IR Protection to Shade 12 at all times.



Part No.	Description	Price
845 2883	Meteor 2185 (Black)	£55.45
845 2886	Meteor 2300F (Flame)	£70.00



HAND DRILL VICE

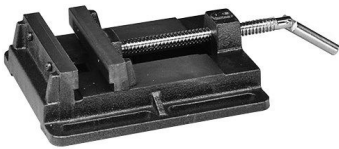

Drill Vices are Constructed from Heavy-Duty Cast Iron. Suitable for most Trade, Workshop and Garage Applications.



Part No.	Description	Price
845 7709	3.0" Drill Vice	£34.44
845 1724	5.0" Drill Vice	£34.77
845 1726	6.0" Drill Vice	£42.15

6" BENCH GRINDER



6" Professional Bench Grinder

Complete with Two Grinding Wheels
Robust Metal Housing
Wire Wheel Included
Built-in NVR Switch



Part No.	Price
845 7625	£135.90

WELDING CLAMPS



Welding Clamp Set Includes:
8.0" Bending Clamp
9.0" Welding Clamp
11.0" Locking 'C' Clamp



Part No.	Price
845 9530	£30.40

MAGNETIC HOLDER



Magnetic Holders Allow for Secure Positioning and Fixing of Materials Prior to, and During, Welding. Available in 45lbs and 80lbs Capacities, and Suitable for the most Demanding Tasks.



Part No.	Description	Price
845 9550	Magnetic Holder 'M' Model	£9.84
845 9552	Magnetic Holder 'L' Model	£13.47

WELDERS ANGLE CLAMP

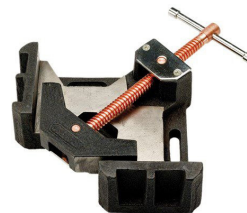

Solid Cast Iron Construction. Ideal for One Person Operation. Specialist Angle Jig/Fixture Clamp. Oblong Holes for Easy Bench Fixing. Copper Plated Spindle for Further Spatter and Spark Protection.



Part No.	Description	Price
845 7648	6" Angle Clamp	£69.95
845 7649	9" Angle Clamp	£92.40



We are an Authorised Distributor of SIP Industrial Products. SIP Industrial have been Designing and Manufacturing the Highest Quality Welding and Compressed Air Technology Since 1968.

Please See our Website for Special Offers and Promotions - www.lsengineers.co.uk

Welding Products



Welding Helmet - Auto Shade

Premium quality, solar powered helmet. Filter darkens instantly when the arc is struck.

- Fibreglass reinforced resin construction
- Total weight 460g including cassette
- Improved mechanism simplifies cassette changing
- Ergonomic headband with replaceable brow band & locking ratchet adjustment
- Conforms to DIN, GS, CE & EN 379 Spec
- Clear lens fitted to protect cassette
- Dark shade 11/Light shade 4
- Darkening time less than 0.2sec
- Clearing time 0.2 sec
- UV/IR protection to shade 12 at all times

Part No.	Price
200 154	£65.00

HAND HELD WELDING MASK



Hand Held Welding Mask
Complete with Shade 11 &
Clear Lenses

Part No.	Description	Price
200 184	Welding Mask	£10.50
200 185	Replacement Lens - Clear	£0.35
200 186	Replacement Lens - Dark	£0.80

WELDERS GAUNTLETS



High Quality Red Leather
Welders Gauntlets
Flock Lined

Part No.	Price (pair)
200 220	£5.25

WELDERS APRON



Chrome Leather Bib Type
Welding Apron

Size: 36" x 24"
c/w Cotton Ties

Part No.	Price
200 407	£9.95

WELDING HEADSHIELD



Flip Up Welding Headshield
Complete with Shade 11 &
Clear Lenses

Part No.	Description	Price
200 187	Welding Mask	£10.90
200 185	Replacement Lens - Clear	£0.35
200 186	Replacement Lens - Dark	£0.80

WELDING SLEEVES

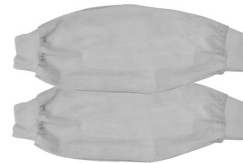

Chrome Leather Welders
Sleeves - 1 Pair

Elasticated Both Ends

Part No.	Size	Price
200 408	14"	£7.35
200 409	18"	£8.95

GAS WELDING GOGGLES



Gas Welding Flip Up Goggles

Part No.	Price
200 210	£5.15

WELDING GAITERS



Chrome Leather Welders
Gaiters - 1 Pair

Velcro Fastened

Part No.	Size	Price
200 410	9"	£12.50
200 411	12"	£14.90

Welding Products

LEATHER WELDERS HOOD



Heavy Duty, Hook & Loop Fastening and comes in One Size
Manufactured from split cow hide leather with Kevlar® stitching
Conforms to EN ISO 11611

Part No.	Price
SEASSP145	£23.30

KNEE PADS

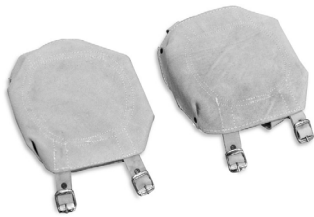

Chrome Leather Welders
Knee Pads - 1 Pair

Foam Lined, Buckle Straps

Part No.	Price
200 414	£15.83

WELD CHIPPING HAMMER



Weld Chipping Hammer

Part No.	Price
200 209	£2.40

PAINT MARKERS



Write sharp, defined, bright marks on any surface including metal, plastic, glass, concrete, rubber and more

Part No.	Colour	Price
200 7842	White	£5.70
200 7852	Yellow	£5.70

FRENCH CHALK STICKS



French Chalk Sticks
For Marking Out Work

Part No.	Size	Price (ea)
200 328	Chalk Sticks 100x10x10mm	£0.22
200 329	Chalk Thins 127x13x5mm	£0.12
200 330	Holder for Chalk Thins	£1.65

STEEL RULE



Stainless Steel Rule,
Permanently Etched &
Polished to Give Long
Lasting Clarity & Accuracy
of Measurement

FISCO

Part No.	Size	Price
902 1966	12"	£3.47

LOCKING PLIERS



Locking Pliers with Curved,
Serrated Jaws
Spring Action
Hardened & Tempered Jaws
Size: 230mm, Capacity: 41mm

Part No.	Price
902 1910	£9.52

SELF GRIP C-CLAMP



280mm Self Grip C-Clamp

Nickle Plated with Quick
Release Lever

Part No.	Price
902 1911	£12.25

WELDING CLAMP



280mm Self Grip Welding
Clamp

Nickle Plated with Quick
Release Lever

Part No.	Price
902 1912	£13.85

WELDING CURTAIN



Welding Curtain 6ft x 6ft on a
Free Standing Frame
Comes with 24 Clips

Flame Retardant

Part No.	Description	Price
200 225	Welding Curtain Complete	£77.35
1468	Curtain Only	£29.90
1472	Frame Only	£38.68
1474	Clip (ea)	£0.80

Welding Products

MILD STEEL ELECTRODES

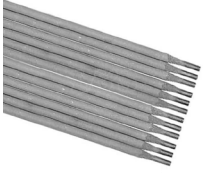

General Purpose - Mild Structural Steels
Can Be Used in all Positions
AC and DC Current
5kg Packs

Part No.	Size	Length	Price
845 274	2.0mm	300mm	£21.13
845 275	2.5mm	350mm	£18.67
845 276	3.2mm	350mm	£17.97
845 285	4.0mm	400mm	£16.02

LOW HYDROGEN ELECTRODES

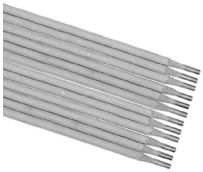

Low Hydrogen - High Tensile & Low Alloy Mild Steels
Can Be Used in all Positions
AC and DC Current
5kg Packs

Part No.	Size	Length	Price
885 250	2.5mm	350mm	£20.03
885 320	3.2mm	350mm	£18.85
885 400	4.0mm	400mm	£15.90

ST/STEEL ELECTRODES

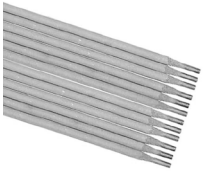

Stainless Steel E308L Electrodes
For Welding 301, 302, 304 & 308 Stainless Steels
AC and DC Current

Part No.	Size	Length	Pack	Price
885 7438	2.5mm	300mm	2kg	£36.59
885 7439	3.2mm	350mm	4kg	£82.82

ELECTRODE HOLDER



Welding Electrode Holder
Twist Type - 400 Amp

Part No.	Price
200 189	£9.25

ELECTRODE HOLDER



Welding Electrode Holder
Clamp Type - 200 Amp

Part No.	Price
200 202	£8.35

WELDING CABLE



Single Insulated Black
Welding Cable

Part No.	Size	Length	Price
124 0058	25mm ² / 200 Amp	5m	£25.62
124 0059	25mm ² / 200 Amp	25m	£123.00
124 0060	25mm ² / 200 Amp	50m	£227.70
124 0061	35mm ² / 252 Amp	5m	£35.86
124 0062	35mm ² / 252 Amp	25m	£160.80
124 0063	35mm ² / 252 Amp	50m	£320.00

PANEL SOCKETS



Dinse Type Panel Sockets

Part No.	Size	Amps	Price
200 203	10-25mm Female	25 Amp	£2.65
200 204	35-50mm Female	35 Amp	£4.25

CABLE PLUGS



Dinse Type Cable Plugs

Part No.	Size	Amps	Price
200 205	10-25mm Male	25 Amp	£2.65
200 206	35-50mm Male	35 Amp	£4.25

CABLE SOCKETS



Dinse Type Cable Sockets

Part No.	Size	Amps	Price
200 207	10-25mm Female	25 Amp	£2.65
200 208	35-50mm Female	35 Amp	£4.45

HEAVY DUTY EARTH CLAMP



Welding Earth Clamp
Heavy Duty, 400 Amp

Part No.	Price
200 188	£4.25

Welding Products



Gas Cutting & Welding Set

SWP Acetylene cutting & welding set in a sturdy plastic carrying case.

Set Comprises:

- Shank, Mixer & Cutting Attachment
- 7 x Swaged Welding Nozzles
- 2 x ANM-S Cutting Nozzles
- Spark Lighter
- Tip Cleaning Set
- Bottle Spanner

Part No.	Price
200 197	£223.60

SHANK SECTION



SWP Combined Acetylene Cutting & Welding Blowpipe Shank Only

Part No.	Price
200 921	£39.13

SINGLE STAGE REGULATORS



100% Tested
Safe By Design
Brass Forged Body & Bonnet



New Design P.A. Knob Provides Ease Of Operation Relief Valve Ensures Safe Venting Of Excess Pressure

Part No.	Type	Max. Pressure	Price
200 190	Oxygen	10 Bar (150 psi)	£34.15
200 191	Acetylene	1.5 Bar (22 psi)	£34.15
885 7450	Argon/CO ²	10 Bar (150 psi)	£34.89
200 192	Propane	2 Bar (30 psi)	£34.15

CUTTING ATTACHMENT



SWP Combined Acetylene Cutting & Welding Blowpipe Cutting Attachment

Part No.	Price
200 922	£46.73

OXY/ACETYLENE HOSE SETS



Oxygen/Acetylene Hose Sets
Blue - Oxygen
Red - Acetylene
6mm Hose
3/8" Cylinder Valve
3/8" Nut & Tail

Part No.	Description	Price
200 417	5m	£34.10
200 418	10m	£42.20
200 419	20m	£83.60

STANDARD MIXER



SWP Combined Acetylene Cutting & Welding Blowpipe Standard Mixer

Part No.	Price
200 923	£12.10

FLASHBACK ARRESTORS



Flashback Arrestors
Oxygen 3/4" R/H Nut
Fuel Gas 3/4" L/H Nut

CUTTING TORCH 18" / 90°



Cutting latch lever for operator comfort On/off valves easy to operate, even with gloves on 18" overall length Angle of head 90 degrees

Part No.	Price
200 193	£32.50

Part No.	Description	Price
200 194	Oxygen	£20.72
200 195	Fuel Gas	£20.72

Welding Products

WELDING NOZZLES

Swaged Gas Welding Nozzles



Part No.	Nozzle Size	Mild Steel Thickness			Price
040 101	1	0.9mm	-	20 swg	£3.55
040 102	2	1.2mm	-	18 swg	£3.55
040 103	3	2.0mm	-	14 swg	£3.55
040 105	5	2.6mm	-	12 swg	£3.55
040 107	7	3.2mm	1/8"	10 swg	£3.55
040 110	10	4.0mm	5/32"	8 swg	£3.55
040 113	13	5.0mm	3/16"	6 swg	£3.55
040 118	18	6.5mm	1/4"	3 swg	£4.45
040 125	25	8.2mm	5/16"	0 swg	£4.75

ACETYLENE CUTTING NOZZLES

A-NM S Acetylene Cutting Nozzles



Part No.	Nozzle Size	Mild Steel Thickness	Price
200 746	1/32"	3-6mm	£4.15
200 747	3/64"	5-12mm	£4.15
200 748	1/16"	10-75mm	£4.15

PROPANE CUTTING NOZZLES

P-NM S Propane Cutting Nozzles



Part No.	Nozzle Size	Mild Steel Thickness	Price
200 995	1/32"	3-6mm	£4.15
200 996	3/64"	5-12mm	£4.15
200 997	1/16"	10-75mm	£4.15

MILD STEEL WELDING RODS

Gas Welding Rods
Copper Coated Mild Steel
For Mild Steel & Wrought Iron

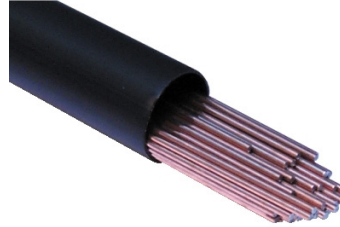

Part No.	Size	Pack	Price
845 123	1.6mm	2kg	£23.27
845 124	2.4mm	2kg	£19.83
845 125	3.2mm	2kg	£21.58

BRAZING FLUX 500G

Weldflux 500g Tub



Part No.	Price
200 222	£13.50

TRIPLE FLINT LIGHTER

Triple Flint Spark Ignition Gun
Complete with Flints

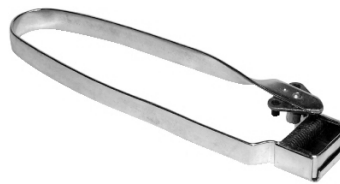

Part No.	Description	Price
845 286	Triple Flint Lighter	£2.65
200 230	Spare Flints	£0.75

WELDING NOZZLE CLEANER

Welding Nozzle Cleaner
Assortment Of Nozzle
Cleaning Probes



Part No.	Price
200 231	£1.95

Welding Products

GAS BOTTLE KEY



Gas Bottle Spindle Key

Part No.	Price
200 226	£1.85

COMBINATION SPANNER



Gas Bottle Combination Spanner

Part No.	Price
200 227	£2.50

CYLINDER TROLLEYS



Robust Construction Heavy Gauge Steel - Welded Joints
Solid Tyred Large Diameter Wheels

Part No.	Type	Size	Price
200 201	Oxygen / Acetylene	Single	£98.00
200 857	Oxygen & Acetylene	Double	£94.70
200 992	Propane (46kg)	Single	£91.40
297 005	Oxygen & Propane	Double	£105.80
297 006	Porta-Pack	Double	£78.86

GAS LEAK DETECT SPRAY



Gas Leak Detection Spray
Non Flammable
400ml Aerosol

Part No.	Price
200 969	£3.25

ANTI SPLATTER SPRAY



Prevents Adhesion of Weld Spatter
Protects Shrouds, Jigs, Fixtures &
Workpieces
300ml Aerosol

Part No.	Price
200 228	£2.65

MIG TORCH KITS



Air Cooled Mig Torch Kits
c/w Euro Fitting

Compatible with Binzel
60% Duty Cycle

3m Cable Length

Part No.	Rating	Binzel	Wire Ø	Price
200 198	150 Amp	Type 15	0.6 - 1.0mm	£55.65
200 199	200 Amp	Type 25	0.6 - 1.2mm	£83.03

MIG WELDING SHROUDS



Mig Welding Shrouds

Part No.	Binzel Type	Price
845 215	Type 15	£2.50
297 007	Type 25	£2.70

MIG CONTACT TIPS



Mig Contact Tips - ECU
M6 x 25mm

Part No.	Wire Ø	Binzel Type	Price
845 211	0.6mm	Type 15	£0.90
845 212	0.8mm	Type 15	£0.95
845 213	1.0mm	Type 15	£0.90
297 008	0.6mm	Type 25	£0.95
297 009	0.8mm	Type 25	£0.90
297 010	1.0mm	Type 25	£0.90

MILD STEEL MIG WIRE ROLLS



Copper Coated, De-Oxidised
Mild Steel Mig Welding Wire

EN440 AWS A5.18: ER70S-6

Part No.	Wire Ø	Roll	Price
MWW1	0.6mm	0.7kg	£3.90
MWW2	0.8mm	0.7kg	£3.15
MWW4	0.6mm	5 kg	£21.20
MWW3	0.8mm	5 kg	£14.43
MWW5	0.8mm	15 kg	£44.17
MWW6	1.0mm	15 kg	£43.28
MWW7	1.2mm	15 kg	£43.28

Soldering Products

GASLESS MIG WIRE



Flux Cored Gasless Mig Wire

Wire Dia. 0.8mm
0.5kg spool

Part No.	Price
200 434	£8.50

FIXT SUPERGLUE GEL



Thick Adhesive Ideal For Vertical Surfaces

3g Tube

Part No.	Price
FX085553	£1.46

40 WATT SOLDERING IRON



40W 240v Light Duty Soldering Iron
3.5mm Dia. Tip

Spare Tips Available

Part No.	Price
902 1845	£10.78

FIXT SUPERGLUE LIQUID



Low Viscosity Instant Superglue Adhesive

20g Bottle

Part No.	Price
FX085555	£2.66

MULTICORE SOLDER



Flux Cored Soldering Wire

Part No.	Wire Ø	Roll	Price
845 119	1.6mm (16swg)	1/2kg	£32.30
845 118	3.5mm (10swg)	1/2kg	£32.07

FIXT NUT LOCK



For Locking & Sealing of Nuts, Bolts & Hydraulic or Pneumatic Components

Part No.	Description	Price
FX085562	10ml Bottle	£3.40
FX085563	50ml Bottle	£7.63

TINMANS SOLDER STICK



Tinmans Solder Stick - 1/4kg

Part No.	Price
845 117	£9.17

FIXT STUD LOCK



For Locking and Sealing of Studs, Nuts & Bolts Not Requiring To Be Disassembled

50ml Bottle

Part No.	Price
FX085567	£7.78

SOLDERING FLUID 500ML



Soldering Flux Fluid For Soldering & Tinning

500ml Bottle

Part No.	Price
845 122	£10.93

FIXT RETAINER



For retaining of close fitting parts. Use on bushes, shafts, rotors & pulleys

1 x 10ml Bottle

Part No.	Price
FX085564	£3.15

Chemicals & Sprays

ASSORTED FIXT ANEROBICS



Contains: Nut Lock, Stud Lock, Retainer

3 x 50ml Bottles



Part No.	Price
FX085560	£22.97

FIXT RAPID EPOXY



Bonds Metal, Wood, Glass, Ceramic, Porcelain
Sets in 5 Minutes
25ml Syringe



Part No.	Price
FX085557	£3.98

LOCTITE 243



Medium Strength Threadlocker
Locks & Seals Studs
Seals Against Corrosion
Restores Worn Bearing Housings
Allows Disassembly
10ml Bottle



Part No.	Price
865 611	£14.95

DOUBLE BUBBLE EPOXY KIT



'Double Bubble' Mix & Fix Epoxy Kit. Bonds to concrete, stone, wood, glass, metal etc.
Fast Cure Epoxy
Sets in 3-5 Minutes

Part No.	Price
865 275	£2.00

LOCTITE 648



Sleeve & Bush Retainer
For Retaining Bearings, Liners & All Cylindrical Parts
Prevents Corrosion
Allows Disassembly
50ml Bottle



Part No.	Price
865 614	£61.42

FIXT EPOXY PUTTY STICK



Hand Knead-able
For Re-Building Damaged Castings & Worn Parts

180mm x 20mm x 140g



Part No.	Description	Price
200 777	Steel	£8.30
200 778	Aluminium	£7.90

Q-BOND ADHESIVE SYSTEM



Ultra Strong Adhesive & Repair System
Repairs Cracks, Holes & Gaps in Metal, Plastic, Wood & More
Bonds in 10 Seconds

Part No.	Price
865 280	£10.50

EVOSTICK IMPACT ADHESIVE



Bonds Decorative Laminates (eg. Formica), Rigid PVC, Wood, Chipboard, Hardboard, Cork, Leather, Rubber, Stone, Metal & Firm Fabrics



Part No.	Description	Price
865 258	70g Tube	£8.41
865 259	500ml Tin	£17.30

SUPER STEEL EPOXY WELD



Epoxy Repair Compound Fixes, Fills & Bonds to Any Surface Including: Metal, Wood, Ceramic & Plastics, 2 x 25g Tubes



Part No.	Price
865 257	£9.15

FIXT SPRAY ADHESIVE



High Strength Adhesive
Ideal for Vehicle Interiors

400ml Aerosol



Part No.	Price
FX085550	£4.20

Chemicals & Sprays

FIXT CLEAR INSTANT GASKET



FIXT Clear Instant Gasket,
Sealing & Bonding Compound
Grade 300

◀ **FIXT** ▶

Part No.	Description	Price
FX085525	40ml Tube	£3.07
FX085526	100ml Tube	£3.88

FIXT SILICONE SEALANT



Engineering Grade Silicone
Sealant & Adhesive Compound

300ml Cartridge

◀ **FIXT** ▶

Part No.	Colour	Price
FX085530	Black	£5.38
FX085531	White	£5.38
FX085528	Clear	£4.85

BLUE HYLOMAR



Non Setting Universal Joining
Compound, Resistant To
Fuels and Lubricants

100g Tube

HYLOMAR

Part No.	Price
865 135	£11.03

HIGH TEMP SILICONE SEALANT



FIXT High Performance
Silicone Sealant - Red
Temperatures up to 330°C

200ml Cartridge

◀ **FIXT** ▶

Part No.	Price
FX085533	£18.22

HONDA LIQUID GASKET



Black Silicone Gasket
Suitable for Honda GCV,
GXH50 GX100 Engines

100ml Tube

Part No.	Price
TB1207B	£25.83

CAULKING GUN



Suitable For Cartridges
up to 310ml

Part No.	Price
865 246	£4.50

GASKET REMOVER 400ML



Removes all types of chemical gas-
kets eliminating excessive scraping.
Softens chemical gaskets quickly

LOCTITE

Part No.	Price
865 624	£10.63

LIQUID NAILS



Instantly Bonds:
Brick, Carpet, Ceramics, Cork,
Glass, Metal, Plaster, Plasterboard,
Plastic, PVC, Wood

295ml Cartridge

Part No.	Price
200 064	£2.56

EXPANDING FILL & FIX FOAM



Fix & Fix Expanding Foam
Quick Setting
Fills Irregular Gaps
Fixes Framework & Insulates

500ml Aerosol

Part No.	Price
865 715	£9.92

Chemicals & Sprays

HOLTS GUN GUM



Holts Gun Gum
Gas Tight Silencer
Repair Paste

200g Tub



Part No.	Price
865 671	£4.19

SMOKE TREATMENT



STP Smoke Treatment
Reduces Exhaust Smoke & Oil
Consumption

450ml Bottle



Part No.	Price
865 516	£6.31

STP VALETING SPRAY



STP Son Of A Gun! Restores The
Lustre and Shine of Vinyl, Leather,
Rubber, PVC, Wood and Plastic.
Helps Protect Against Weathering

250ml Pump Bottle



Part No.	Price
865 518	£5.60

FUEL INJECTOR CLEANER



High Strength Injector Cleaner
Removes Deposits from Fuel
Injection Systems. Safe With
Catalytic Converters

250ml Bottle



Part No.	Price
963 350	£5.50

OIL TREATMENT



STP Oil Treatment
Formulated To Reduce Engine
Wear & Keep Engines Cleaner

300ml Ring-Pull Tin



Part No.	Price
865 511	£6.03

DIESEL INJECTOR CLEANER



High Strength Injector Cleaner
Removes Deposits from Diesel
Injection Systems

250ml Bottle



Part No.	Price
963 300	£7.70

ENGINE FLUSH



STP Engine Flush
Removes Harmful Sludge &
Deposits For Petrol and Diesel
Engines

450ml Ring-Pull Tin



Part No.	Price
865 512	£6.17

DIESEL TREATMENT



Removes Varnish, Carbon
Deposits & Water From Diesel Fuel
Systems Prevents Corrosion, Poor
Performance & Starting Problems.

250ml Bottle



Part No.	Price
963 250	£5.50

BRADDEX EASY START



HOLTS-BRADDEX Easy Start
Assists Engine Starting

280ml Aerosol Can



Part No.	Price
865 701	£4.60

POWER STEERING FLUID



STP Power Steering Fluid
Stops/Reduces Leakage By
Revitalising Seals

350ml Bottle



Part No.	Price
865 517	£3.90

Chemicals & Sprays

GT85 RELEASE SPRAY



General Purpose Cleaning/Lubricating Spray
Powerful Penetrating Oil & Water Displacer Cleans & Protects

400ml Aerosol

Part No.	Price
GT85	£2.35

WD40 - SMART STRAW



WD-40 Drives Out Moisture
Cleans & Protects
Loosens Rusted Parts
Aerosol



Part No.	Size	Price
865 480	450ml	£6.25
902 440	600ml	£6.33

MAINTENANCE SPRAY



High Specification Multi-purpose Fluid Displaces Moisture, Cleans & Lubricates Low Viscosity For Maximum Coverage Long Lasting Protection From Moisture

400ml Aerosol



Part No.	Price
FX081127	£3.25

WD40 - 5 LITRE



Stops Squeaks, Drives Out Moisture
Cleans & Protects
Loosens Rusted Parts

5 Litre Plastican



Part No.	Price
999 770	£33.50

MAINTENANCE FLUID - 5 LITRE



High Specification Multi-purpose Fluid Displaces Moisture, Cleans & Lubricates Low Viscosity For Maximum Coverage Long Lasting Protection From Moisture

5 Litre Plastican



Part No.	Price
FX081128	£22.95

SWARFEGA JIZER - 5 LITRE



The Swarfega Jizer Degreaser is a Parts Degreaser which Quickly Dissolves Heavy Deposits of Mineral Oil, Grease, Tar, Bitumen and Waxes.

5 Litres



Part No.	Price
963 450	£39.00

WHITE GREASE WITH PTFE



Visible White Lubricant
Resistant To Heat, Salt & Moisture
Ideal For Linkages, Latches, Gears, Hinges, Weatherproofs & Protects

400ml Aerosol



Part No.	Price
FX081151	£3.85

SILICONE GREASE



Outstanding Lubricating Properties
Protects Against Damp & Corrosion
Preserves & Protects Rubber Components
Insulates & Protects Electrical Components

400ml Aerosol



Part No.	Price
FX081161	£5.42

WHITE FOOD GREASE



Non Toxic Silicone Free Light Oil
Lubricant Heat Stable, Non Toxic
Suitable For Food-Safe Environments

400ml Aerosol



Part No.	Price
FX081153	£4.03

PENETRATING & GRAPHITE



Tough Graphite Enhanced Lubricant
Powerful Heavy-duty Industrial Formula Provides A Strong Graphite Film Providing A High Level Of Lubrication

400ml Aerosol



Part No.	Price
FX081275	£3.36

Chemicals & Sprays

COPPER GREASE



Copper Grease
Anti-Seize Compound
Prevents Disc Brake Squeal

85g Tube

Part No.	Price
865 116	£5.02

COPPER ANTI-SEIZE



Thick, Protective Lubricant For
Metal Parts Prevents Corrosion,
Seizure & Brake Squeal Effective At
Temperatures Up To 1100 °c High-
Grip Anti Fling - Will Not Wash Off
400ml Aerosol



Part No.	Price
FX081154	£4.50

PENETRATING FLUID



Freeway Penetrating Fluid
Releases The Most Stubborn Of
Rusted On Parts

500ml Tin

Part No.	Price
865 117	£14.70

3-IN-ONE MULTIPURPOSE OIL



3-IN-ONE Lubricating Oil
Lubricates, Penetrates, Cleans &
Prevents Rust

100ml Tin

Part No.	Price
865 321	£3.42

DUCK OIL 5 LITRE



For Use On Intricate Machinery
Parts & For Removing Moisture
From Electrical Parts Low Viscosity,
Silicone-free, Film Forming,
High Flash Point, 5 Litre Can c/w
Dispenser

Swarfega

Part No.	Price
200 065	£44.98

WIRE ROPE & CHAIN SPRAY



Coating For Chains, Cables & Open
Gearing Reduces Wear & Increases
Component Life High-Grip 'stay-
put' Coating Easy To Apply In-Situ

400ml Aerosol



Part No.	Price
FX081276	£4.15

FOAMING CLEANER



Tough, Fast Acting Foaming Cleaner
Rapidly Cleans Trims, Fabrics,
Tools etc. Foaming Action Provides
Deeper Cleansing Suitable As A
Hard Surface Cleaner For Plastic,
Glass, Wood & Whiteboards etc.

400ml Aerosol



Part No.	Price
FX081208	£2.99

GLASS & MIRROR CLEANER



Fast-Acting Foam, Pleasant Smell
& Easy To Use. Non-Smearing
& Leaves No Greasy Film Or
Residue. Ideal For Screens, VDU's,
Light Fittings & Mirrors

400ml Aerosol



Part No.	Price
FX081207	£3.10

DEGREASER SPRAY



Removes Grease, Tar, Dirt, Oil &
Bitumen Suitable For Degreasing
Concrete Floors Fast Acting,
Biodegradable Formulation Fully
Soluble, Can Be Rinsed With Water
400ml Aerosol



Part No.	Price
FX081329	£3.70

DEGREASER FLUID



Removes Grease, Tar, Dirt, Oil &
Bitumen Suitable For Degreasing
Concrete Floors Fast Acting, Biode-
gradable Formulation Fully Soluble
- Can Be Rinsed With Water
5 Litre Can



Part No.	Price
FX081175	£22.52

Chemicals & Sprays

BRAKE & CLUTCH SPRAY



Instantly Removes Brake Dust, Oil & Grease Apply Without Dismantling Parts Helps Prevent Brake Squeal Non-Corrosive To Brake Rubbers
400ml Aerosol



Part No.	Price
FX081104	£3.55

BRAKE & CLUTCH CLEANER



Instantly Removes Brake Dust, Oil & Grease Apply Without Dismantling Parts Helps Prevent Brake Squeal Non-Corrosive To Brake Rubbers
1 litre Bottle



Part No.	Price
FX081112	£5.23

CARB & INJECTOR CLEANER



Cleans Fuel & Injection Components Removes Carbon From Valves & Venturis Fast Deep Cleaning Formula Improves Engine Performance & Tickover

400ml Aerosol



Part No.	Price
FX081375	£3.10

ELECTRICAL CLEANER



Powerful Spray Clears Contamination Fast Evaporating, Leaves No Residue Removes Dust, Grease, Tar, Dirt & Oil Safe To Use On Most Plastics

400ml Aerosol



Part No.	Price
FX081350	£3.70

COCKPIT SHINE



Fast Shining Dashboard Renovator Long Lasting Cherry Fragrance Eliminates Dashboard Squeaks Ideal For Plastic, Vinyl, Rubber & Wood

400ml Aerosol



Part No.	Price
FX081209	£3.65

AIR DUSTER



Safely Removes Dust & Foreign Objects Completely Dry & Leaves No Residue Safe To Use On Electrical Equip, VDU's etc. Ozone Friendly Propellant

400ml Aerosol



Part No.	Price
FX081210	£5.31

CARPET SHAMPOO



Low Foam Carpet Shampoo For Use With Electric Carpet Cleaners

750ml Bottle

Part No.	Price
200 835	£4.40

GRAFFITI REMOVER



Removes Graffiti From Most Porous & Non Porous Surfaces Highly Effective On Felt Tip Pens, Ballpoint Pens & Most Paints, Inks etc.

400ml Aerosol

Part No.	Price
200 800	£7.23

INK & CHEWING GUM REMOVER



Ideal For The Removal Of Ink, Chewing Gum, Toffee, Putty Etc. From Carpets, Upholstery And Wood Leaves Surfaces Tack-free

400ml Aerosol

Part No.	Price
200 801	£6.77

SPRAY BOTTLE



500ml Trigger Spray Applicator

Suitable for use with many solvent based chemicals

Part No.	Price
895 090	£2.95

SPRAY PUMP



1 Litre Pump Spray Applicator

Suitable for use with many solvent based chemicals

Part No.	Price
895 059	£27.50

Workwear & PPE

HIGH-VIS JACKETS



High Visibility Waterproof Jacket

Yellow or Orange
EN471 Class 3

Part No.	Colour	Size	Price
907 1000	Yellow	Small	£23.85
907 1001	Yellow	Medium	£23.85
907 1002	Yellow	Large	£23.85
907 1003	Yellow	X Large	£23.85
907 1004	Yellow	XX Large	£23.85
907 1005	Orange	Small	£23.85
907 1006	Orange	Medium	£23.85
907 1007	Orange	Large	£23.85
907 1008	Orange	X Large	£23.85
907 1009	Orange	XX Large	£23.85

HIGH-VIS OVERTROUSERS



High Visibility Waterproof Overtrousers

Yellow or Orange
EN471 Class 1

Part No.	Colour	Size	Price
907 1055	Yellow	Small	£10.82
907 1056	Yellow	Medium	£10.82
907 1057	Yellow	Large	£10.82
907 1058	Yellow	X Large	£10.82
907 1059	Yellow	XX Large	£10.82
907 1060	Orange	Small	£10.82
907 1061	Orange	Medium	£10.82
907 1062	Orange	Large	£10.82
907 1063	Orange	X Large	£10.82
907 1064	Orange	XX Large	£10.82

HIGH-VIS VEST



High Visibility Vest

Yellow or Orange
EN471 Class 2

Part No.	Colour	Size	Price
907 1020	Yellow	Medium	£2.92
907 1021	Yellow	Large	£2.92
907 1022	Yellow	X Large	£2.92
907 1023	Yellow	XX Large	£2.92
907 1024	Orange	Medium	£2.92
907 1025	Orange	Large	£2.92
907 1026	Orange	X Large	£2.92
907 1027	Orange	XX Large	£2.92

HIGH-VIS SWEATSHIRTS



Conforms to BS EN 471: 2003 Class 3, Conforms to Railway Group, Standard GO/RT 3279 (Orange Garments Only)
100% Polyester

Part No.	Colour	Size	Price
724 0041	Yellow	Medium	£17.60
724 0042	Yellow	Large	£17.60
724 0043	Yellow	X Large	£17.60
724 0031	Orange	Medium	£17.60
724 0032	Orange	Large	£17.60
724 0033	Orange	X Large	£17.60

HIGH-VIS SLEEVED WAISTCOAT



High Visibility Long Sleeved Waistcoat

Yellow or Orange
EN471 Class 3

Part No.	Colour	Size	Price
907 1035	Yellow	Medium	£5.30
907 1036	Yellow	Large	£5.30
907 1037	Yellow	X Large	£5.30
907 1038	Yellow	XX Large	£5.30
907 1039	Orange	Medium	£5.30
907 1040	Orange	Large	£5.30
907 1041	Orange	X Large	£5.30
907 1042	Orange	XX Large	£5.30

HIGH-VIS POLO SHIRTS



Conforms to BS EN 471: 2003 Class 2, Conforms to Railway Group, Standard GO/RT 3279 (Orange Garments Only)
100% Polyester

Part No.	Colour	Size	Price
724 0101	Yellow	Medium	£10.15
724 0102	Yellow	Large	£10.15
724 0103	Yellow	X Large	£10.15
724 0091	Orange	Medium	£10.15
724 0092	Orange	Large	£10.15
724 0093	Orange	X Large	£10.15

2 PIECE RAINSUIT



PVC/Polyester Waist Length Jacket with Hood
Trousers with Elasticated Waist & Press Stud Adjustment at Ankle

Part No.	Colour	Size	Price
907 1075	Navy	Medium	£14.59
907 1076	Navy	Large	£14.59
907 1077	Navy	X Large	£14.59
907 1078	Navy	XX Large	£14.59

HIGH-VIS LONG-SLEEVE POLO



Conforms to EN ISO 20471: 2003 Class 3, Conforms to Railway Group, Standard GO/RT 3279 (Orange Garments Only)
100% Polyester

Part No.	Colour	Size	Price
724 0061	Yellow	Medium	£15.46
724 0062	Yellow	Large	£15.46
724 0063	Yellow	X Large	£15.46
724 0051	Orange	Medium	£15.46
724 0052	Orange	Large	£15.46
724 0053	Orange	X Large	£15.46

Workwear & PPE

FUNCTION UNIVERSAL JACKET



Comfortable & Practical
Work Jacket
Cotton/Polyester Blend

No Chainsaw Protection

STIHL®

Part No.	Size	Chest	Price
0088 335 0704	Medium	41"	£62.79
0088 335 0705	Large	44"	£62.79
0088 335 0706	X Large	47"	£62.79
0088 335 0707	XX Large	49"	£62.79

CHAINSAW TROUSERS



Bib & Brace Safety Trousers
Fabric 47% cotton, 53%
Polyamide for breathability
and durability

**Chainsaw Protection to
EN381-5 Class**

Part No.	Waist	Leg	Price
350 257	32 - 34"	Standard	£90.66
350 258	32 - 34"	Long	£90.66
350 259	36 - 38"	Standard	£90.66
350 212	36 - 38"	Long	£90.66
350 260	38 - 40"	Standard	£90.66
350 261	38 - 40"	Long	£90.66

ALL WEATHER JACKET



Hard Wearing All Weather
Work Jacket With Hood
Bi-Elastic Flexible Material

No Chainsaw Protection

STIHL®

Part No.	Size	Chest	Price
0000 885 5452	Medium	41"	£76.79
0000 885 5456	Large	45"	£76.79
0000 885 5460	X Large	48"	£76.79
0000 885 5464	XX Large	51"	£76.79

CHAINSAW TROUSERS



For Occasional use where there are
Multiple Users. Ventilation material
on back of thighs. Easy to put on
and close.

**Chainsaw Protection to
EN ISO 11393 Class I** **STIHL®**

Part No.	Size	Price
0088 508 0100	XS – Medium	£116.80
0088 508 0101	Large – XXL	£116.80

STIHL BRACES



Adjustable Braces With
Metal Clips
Length: 130cm

STIHL®

Part No.	Price
0000 884 1512	£18.84

BRUSHCUTTER TROUSERS



Oregon Brushcutter Trousers
Tear and Scratch Resistant
Fuel, Oil & Heat Resistant
Hi-visibility and Reflective Stripes

No Chainsaw Protection

OREGON

Part No.	Waist	Leg	Price
OR295465/S	30"	31"	£51.03
OR295465/M	32"	31"	£51.03
OR295465/L	34"	32"	£51.03
OR295465/XL	36"	32"	£51.03
OR295465/2XL	38"	33"	£51.03
OR295465/3XL	40"	33"	£51.03

Stihl Workwear

Full range of Stihl Workwear & PPE available to order.
Please note - Stihl sizes tend to be slightly smaller than
UK sizes so order the next size up if there is any doubt.

Workwear & PPE

ECONOMY BODY WARMER



Nylon 4oz Quilted Body Warmer with Nylon Lining & 2 External Pockets

Part No.	Size	Price
907 1210	Small	£21.73
907 1211	Medium	£21.73
907 1212	Large	£21.73
907 1213	X Large	£21.73
907 1214	XX Large	£21.73

POLYCOTTON BOILERSUIT



7.1/4oz Boilersuits in 65/35 Polycotton - Stud Front

6 Large Pockets & 1 Rule Pocket

Part No.	Colour	Chest	Price
907 1250	Navy	38"	£22.97
907 1251	Navy	40"	£22.97
907 1252	Navy	42"	£22.97
907 1253	Navy	44"	£22.97
907 1254	Navy	46"	£22.97
907 1255	Navy	48"	£22.97
907 1256	Navy	50"	£22.97
907 1257	Navy	52"	£22.97
907 1258	Spruce	38"	£22.97
907 1259	Spruce	40"	£22.97
907 1260	Spruce	42"	£22.97
907 1261	Spruce	44"	£22.97
907 1262	Spruce	46"	£22.97
907 1263	Spruce	48"	£22.97
907 1264	Spruce	50"	£22.97
907 1265	Spruce	52"	£22.97
907 1266	Royal	38"	£22.97
907 1267	Royal	40"	£22.97
907 1268	Royal	42"	£22.97
907 1269	Royal	44"	£22.97
907 1270	Royal	46"	£22.97
907 1271	Royal	48"	£22.97
907 1272	Royal	50"	£22.97
907 1273	Royal	52"	£22.97

PADDED BODY WARMER



Lightweight, fully lined and padded Full length internal storm flap Flex stretchable side panels Large left breast zipped pocket Two lower zipped pockets Internal hook & loop closure pocket

Part No.	Size	Price
907 1220	Small	£26.68
907 1221	Medium	£26.68
907 1222	Large	£26.68
907 1223	X Large	£26.68
907 1224	XX Large	£26.68

HIGH-VIS BODY WARMER



High Visibility Quilted Body Warmer

EN471 Class 2

Part No.	Size	Price
907 1230	Small	£24.50
907 1231	Medium	£24.50
907 1232	Large	£24.50
907 1233	X Large	£24.50
907 1234	XX Large	£24.50

FLAME RETARDANT OVERALLS



Treated Lightweight 220gsm coverall, offering maximum protection against heat and flame.

Conforms to EN ISO 11611

Part No.	Colour	Size	Price
724 0131	Navy	Medium	£54.37
724 0132	Navy	Large	£54.37
724 0133	Navy	X Large	£54.37
724 0121	Orange	Medium	£54.37
724 0122	Orange	Large	£54.37
724 0123	Orange	X Large	£54.37

TYVEK EASYSAFE BOILERSUIT



Tyvek 200 Easysafe Dupont certified Type 5, 6 chemical protective coverall

EN 1073-2, (protection against radioactive contamination) Antistatic treatment on outside

Part No.	Size	Chest	Price
896 5941	Small	33" - 36"	£8.58
896 5942	Medium	36" - 39"	£8.58
896 5943	Large	39" - 42"	£8.58
896 5936	X Large	42" - 45"	£8.58
896 5927	XX Large	45" - 48"	£8.58

Harness Safety Equipment

FALL ARREST BLOCK



Retractable Fall Arrest Block

Outer Casing Made from High Resistant Polymer.
Minimum Breaking Strength 15kn.
Fitted with Karabiner at top.
Swivel Snap Hook with Load Indicator at Bottom.
Galvanised Steel Wire Rope 4.8mm.
Minimum Breaking Strength 20kn.

Part No.	Size	Price
493 066	6 Metre	£259.30
493 010	10 Metre	£314.20
493 015	15 Metre	£304.60

HI VIS SAFETY HARNESS



Front & Rear Attachment Points.
Orange Work Vest.
Fully Adjustable.
Adjustable Zip System.
Conforms to:
En 361:2002 En 471:2003

Part No.	Colour	Price
493 302	Orange	£178.00
493 303	Yellow	£94.96

1/4 TURN LOCKING KARABINER



Aluminium Quarter Turn Locking Karabiner
Aluminium Alloy in Green Finish.
Gate Opening : 22mm.
Minimum Breaking Strength: 20kn.

Part No.	Price
493 722	£22.98

TOOLS LANYARD



Designed to Attach Tools to the User or an Anchor Point.

Part No.	Price
493 100	£19.64

SCREW LOCKING KARABINER



Aluminium Screw Locking Karabiner
Aluminium Alloy in Green Finish.
Gate Opening : 22mm.
Minimum Breaking Strength: 20kn.

Part No.	Price
493 522	£18.28

FLAME RESISTANT LANYARD



Flame Resistant Shock Absorbing Webbing Lanyard 44mm Wide Webbing with 44mm Wide Webbing Shock Absorber. Karabiner at One End and Scaffold Hook at the Other End. Shock Absorber Covered in Special Tubular Sleeve.

Part No.	Size	Price
493 510	1 Metre	£56.86
493 520	2 Metre	£53.04

SAFETY HARNESS KITS



Scaffolders Safety Harness / Restraint Kits
Shock Absorbing Webbing Lanyard
Includes Environmentally Friendly Carry Bag.

Part No.	Type	Price
493 001	Scaffolders Single Point	£99.92
493 005	Scaffolders 2 Point	£92.18
493 003	Standard Single Point	£86.14
493 006	2 Point Restraint	£91.58

FULL BODY HARNESS



2 Point Elasticated Full Body Harness
Front & Rear 'D' Rings.
Special Stainless Steel Fittings.
Fully Adjustable.
Elastic Webbing for Comfort and Impact Resistance.

Part No.	Price
493 700	£119.00

Workwear & PPE

FLINT RF440A BLACK SAFETY BOOT



Rock Fall
INDUSTRY DEFINING SAFETY FOOTWEAR

100% non-metallic, with protective toecap and midsole, Flint is comfortable and lightweight, it's developed with specialist comfort materials including a shock absorbing dual density EVA nitrile rubber outsole and Activ-Step® PU anti-fatigue comfort footbed.

Specification:
EN ISO 20345:2011 S3 SRC

Features:

Industries:

- 100% Non-Metallic Construction
- Anti-Static
- Oil Resistant
- Protective Midsole
- Protective Toecap
- Water Repellent Upper

- Construction
- Engineering
- Logistics
- Quarry
- Utilities



Part No.	Size	Price
206 3106	6	£60.07
206 3107	7	£60.07
206 3108	8	£60.07
206 3109	9	£60.07
206 3110	10	£60.07
206 3111	11	£60.07
206 3112	12	£60.07

HERD RF205 BROWN SAFETY BOOT

100% non-metallic, with protective toecap and midsole, Flint is comfortable and lightweight, it's developed with specialist comfort materials including a shock absorbing dual density EVA nitrile rubber outsole and Activ-Step® PU anti-fatigue comfort footbed.

Rock Fall
INDUSTRY DEFINING SAFETY FOOTWEAR

Specification:
EN ISO 20345:2011 S3 SRC



- 100% Non-Metallic Construction
- Anti-Static
- Cold Insulation
- Heat Resistant Outsole to 300°C
- Oil Resistant
- Protective Midsole
- Protective Toecap
- Water Repellent Upper
- Fully Waterproof
- Sustainable

Part No.	Size	Price
206 3206	6	£70.38
206 3207	7	£70.38
206 3208	8	£70.38
206 3209	9	£70.38
206 3210	10	£70.38
206 3211	11	£70.38
206 3212	12	£70.38
206 3213	13	£70.38

GRANITE RF170 SAFETY BOOT



Rock Fall
INDUSTRY DEFINING SAFETY FOOTWEAR

Protective toecap and midsole, Granite is highly robust and developed with specialist durability materials including FORCE10® components, IMPACT SHIELD™ and limited stitching.

Features:

Industries:

- 100% Non-Metallic Construction
- Anti-Static
- Cold Insulation
- Oil Resistant
- Protective Midsole
- Protective Toecap
- Water Repellent Upper
- Highest Level Slip Resistance
- Heat Resistant Outsole to 300°C
- Internal Digging Plate

- Construction
- Engineering
- Logistics
- Quarry
- Utilities
- Foundry
- Fabrication
- Rail
- Highways



Part No.	Size	Price
206 2506	6	£54.08
206 2507	7	£54.08
206 2508	8	£54.08
206 2509	9	£54.08
206 2510	10	£54.08
206 2511	11	£54.08
206 2512	12	£54.08
206 2513	13	£54.08
206 2514	14	£54.08
206 2515	15	£54.08

Workwear & PPE

BALTIMORE PM4008 SAFETY BOOT



100% non-metallic, with protective toecap and midsole, Baltimore is lightweight and developed with premium materials including an Activ-Tex® waterproof membrane and Activ-Step® shock absorbing dual density PU outsole



Features:

- 100% Non-Metallic Construction
- Anti-Static
- Wide Fitting
- Oil Resistant
- Protective Midsole
- Protective Toecap
- Waterproof Membrane
- Highest Level Slip Resistance

Industries:

- Construction
- Engineering
- Logistics
- Highways
- Utilities
- Fabrication
- Facility Manager
- Security

Part No.	Size	Price
206 0606	6	£44.17
206 0607	7	£44.17
206 0608	8	£44.17
206 0609	9	£44.17
206 0610	10	£44.17
206 0611	11	£44.17
206 0612	12	£44.17
206 0613	13	£44.17
206 0614	14	£44.17
206 0615	15	£44.17

ORLANDO TC35 SAFETY BOOT

Protective toecap and midsole, Orlando is lightweight and developed with premium materials including a shock absorbing nitrile rubber outsole and Activ-Step® PU anti-fatigue comfort footbed.

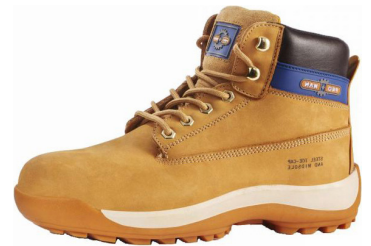

Specification:
EN ISO 20345:2011 S3 SRC

Features:

- Heat Resistant Outsole to 300°C
- Anti-Static
- Oil Resistant
- Protective Midsole
- Protective Toecap
- Water Repellent Upper

Industries:

- Construction
- Engineering
- Logistics



Part No.	Size	Price
206 5106	6	£48.93
206 5107	7	£48.93
206 5108	8	£48.93
206 5109	9	£48.93
206 5110	10	£48.93
206 5111	11	£48.93
206 5112	12	£48.93

FLY RF108 LIGHTWEIGHT SAFETY TRAINER



100% non-metallic, including a fibreglass toecap and composite midsole, Maine is comfortable and lightweight, it's developed with specialist comfort materials including a shock absorbing dual density EVA nitrile rubber outsole and Activ-Step® PU anti-fatigue comfort footbed.



Part No.	Size	Price
206 4606	6	£54.93
206 4607	7	£54.93
206 4608	8	£54.93
206 4609	9	£54.93
206 4610	10	£54.93
206 4611	11	£54.93
206 4612	12	£54.93
206 4613	13	£54.93

- 100% Non-Metallic Construction
- Anti-Static
- Oil Resistant
- Protective Midsole
- Protective Toecap
- Small Sizes Available 2+
- SRC Slip Rated
- Vegan Friendly
- Sustainable
- Water Repellent Upper

Workwear & PPE

RUBBER APRON & GLOVES



Latex Rubber Apron
42" x 36"

Heavyweight Rubber
Gauntlet - 17"

Part No.	Description	Price
200 593	Apron - 42" x 36"	£17.46
200 592	Gauntlet - 17"	£12.77

STEEL TOECAP WELLINGTONS



Steel Toe Cap
Steel Mid-Sole
Oil Resistant Outsole
Antistatic
Energy Absorbing Sole
Waterproof
EN ISO 20345 S5 SRA

Part No.	Size	Price
200 496/6	6	£20.17
200 496/7	7	£20.17
200 496/8	8	£20.17
200 496/9	9	£20.17
200 496/10	10	£20.17
200 496/11	11	£20.17
200 496/12	12	£20.17

SHOE COVERS



Shoe Covers
Quality Hygienic Product
Elasticated to Secure on Foot
Pack of 50 Pairs

Part No.	Price
190 041	£4.42

THERMAL SOCKS



Short Pile Thermal Socks
1 Pair

Part No.	Price
200 572	£1.82

SEA BOOT SOCKS



Traditional Wool Mix Long
Sock for use with
Wellingtons or Waders
1 Pair

Part No.	Colour	Price
200 842	White	£5.53
200 844	Navy	£4.74

WORK SOCKS



Scan Work Socks 2 Pairs
Size 6-12

Part No.	Price
SCASOCKS	£9.32

HI-GRIP GLOVES



Yellow 'Criss-Cross' High
Grip Gloves

Part No.	Price (pair)
200 576	£1.13

WORK GLOVES



Rigger Work Gloves
Colour May Vary

Part No.	Price (pair)
200 406	£1.45

WARRIOR THERMAL GLOVES



Warrior Thermal Hi-Grip
Gloves
Size 10

Part No.	Price (pair)
300 965	£2.17

WELDERS GAUNTLETS



High Quality Red Leather
Welders Gauntlets - Flock Lined

Part No.	Price (pair)
200 220	£5.25

PVC GAUNTLETS



PVC Gauntlets
Fully Coated 14" Long

Part No.	Price (pair)
200 783	£1.84

PVC GLOVES



Knitted Wrist PVC Work
Gloves

Part No.	Price (pair)
200 405	£1.30

Workwear & PPE

DEWALT GEL GLOVES



DeWalt Power Tool Gel Gloves
Silicon Gel Padded Palm to
Reduce Vibrations, Brow Wipe Pad,
Knuckle Strap and Rubber
Finger Grips - Size Large



Part No.	Price
DEWDWGPTG	£29.50

POLYTHENE GLOVES



Disposable 100pk Gloves
Large Size, Fits Either Hand

Part No.	Price
895 208	POA

VINYL GLOVES



Powdered 100pk vinyl disposable
gloves
100% synthetic PVC
Contains no latex / protein
Ambidextrous
Easy to pull on beaded cuff

Part No.	Size	Price
190 000	Small	£6.70
190 015	Medium	£6.70
200 213	Large	£6.70
190 030	X Large	£6.70

ANTI-IMPACT GLOVES



Foam Latex Padded Anti-Impact
Metacarpal Protection Gloves
Rubber coated Palms & HPPE
Lined. Conforms to EN388:2016
and EN420 Standards

Abrasion Performance: 3
Blade Cut Performance: 5
Tear Performance: 4
Puncture Performance: 2

Part No.	Size	Price
SCAGLOAIM	Medium	£10.44
SCAGLOAIL	Large	£10.44
SCAGLOAIXL	X Large	£10.44
SCAGLOAIXX	XX Large	£10.44

LATEX GLOVES



Disposable 100pk gloves
Allows touch sensitive work to be
carried out with ease
Ambidextrous
Easy to pull on beaded cuff

Part No.	Size	Price
300 320	Small	£8.50
300 355	Medium	£8.50
895 206	Large	£8.50
300 380	X Large	£8.50

CHAINSAW SAFETY GLOVES



Soft Leather Safety Gloves
Comfortable & Hard Wearing
Class 0 (0-16m/s)
BS EN 381

Part No.	Size	Price
350 161	Large (10)	£13.94
351 022	X Large (11)	£13.94

NITRILE GLOVES



Nitrile 100pk Disposable Gloves
Powder & Latex Free
CE category III
CE class I examination glove
Fulfilling medical / food contact
requirements

Part No.	Size	Price
610 000	Small	£8.95
610 100	Medium	£8.95
610 200	Large	£8.95
610 300	X Large	£8.95

STIHL CHAINSAW GLOVES



Soft Leather Safety Gloves
Comfortable & Hard Wearing
Class 0 (0-16m/s)
BS EN 381



Part No.	Size	Price
0088 610 0408	Small (8)	£38.63
0088 610 0409	Medium (9)	£38.63
0088 610 0410	Large (10)	£38.63
0088 610 0411	X Large (11)	£38.63

GLOVE BOX DISPENSER



Wall Mounted Disposable Glove
Box Holder / Dispenser
White-Coated Metal Frame
260mm x 125mm x 95mm

Part No.	Price
300 399	£16.34

Husqvarna Accessories

 Husqvarna Please See our Website for more Accessories - www.lsengineers.co.uk

LIGHT WORK GLOVES



A slim fit and comfortable glove made with a goat leather palm with jersey fabric on the back

Part No.	Size (Palm Width)	Price
599 64 94 06	6cm	£17.32
599 64 94 07	7cm	£17.32
599 64 94 08	8cm	£17.32
599 64 94 09	9cm	£17.32
599 64 94 10	10cm	£17.32
599 64 94 12	12cm	£17.32

FUNCTIONAL GLOVES



A comfortable saw protection glove made with a goat leather double palm with foam laminated spandex on the back and with nylon neoprene knuckles

Part No.	Size (Palm Width)	Price
599 65 16 07	7cm	£26.71
599 65 16 08	8cm	£26.71
599 65 16 09	9cm	£26.71
599 65 16 10	10cm	£26.71
599 65 16 12	12cm	£26.71

PROTECTIVE GLASSES-CLEAR



Clear X Protective glasses with non-scratch, clear lenses.

Part No.	Price
544 96 37 01	£12.27

PROTECTIVE GLASSES



Yellow X Protective glasses with non-scratch, Yellow lenses.

Part No.	Price
544 96 37 02	£14.43

PROTECTIVE GLASSES-UV



Sun X Protective glasses with non-scratch, Grey Tinted lenses with UV-Protection.

Part No.	Price
544 96 37 03	£14.43

HEAVY DUTY GLOVES



A one size durable glove made with a goat leather palm with spandex fabric on the back

Part No.	Size (Palm Width)	Price
596 31 05 10	10cm	£12.90

TECHNICAL GLOVES



A Technical glove with high comfort. Goat leather palm with interlock jersey and grey foam and laminated spandex fabric on back

Part No.	Size (Palm Width)	Price
599 65 03 09	9cm	£25.98
599 65 03 10	10cm	£25.98
599 65 03 12	12cm	£25.98

TECH GLOVES/SAW PROTECT



A Technical glove with saw protection 20m/s. Goat leather palm with interlock jersey and grey foam and laminated spandex fabric on back

Part No.	Size (Palm Width)	Price
599 65 12 08	8cm	£39.72
599 65 12 09	9cm	£39.72
599 65 12 10	10cm	£39.72

SUN PROTECTIVE GLASSES-UV



Protective Tinted Sunglasses with UV Protection. non-scratch, grey tinted lenses with UV-protection for better vision in sunny conditions

Part No.	Price
544 96 38 02	£10.76

PROTECTIVE OVER GOGGLES



For people who wear eyeglasses. Featuring anti-fog coated lenses and soft inside for greater comfort

Part No.	Price
544 96 39 01	£18.77

Workwear & PPE

SAFETY GOGGLES



Two Part Molded Frame With Polycarbonate Lens & Direct Vents
BS EN166:1995

Part No.	Price
200 400	£1.44

VISOR WITH ADAPTORS



8" Polycarbonate Visor Only Complete With International Slot Adaptors

Part No.	Price
200 216	£15.50

JUPITOR SAFETY GOGGLES



Optical Class, Anti-Mist Scratch Resistant Polycarbonate Lenses Medium Energy Impact Can Be Worn Over Spectacles Conforms to EN166.1.B.3.4.9

Part No.	Price
200 218	£4.95

MESH FACE SHIELD



Wire Mesh Safety Visor With Adjustable Head Band Conforms to EN 166 & EN 1731

Part No.	Price
200 215	£8.50

E20 SAFETY GLASSES



E20 Scratch Resistant Safety Glasses Complies with EN 166:2001 Personal Eye Protection

Part No.	Price
200 242	£2.18

CLEAR FACE SHIELD



Clear Polycarbonate Safety Visor With Adjustable Head Band Conforms to EN 166 & EN 1731

Part No.	Price
200 214	£6.85

STIHL SAFETY GLASSES



Non Misting, Scratch Resistant Safety Glasses BS EN 166

STIHL®

Part No.	Colour	Price
0000 884 0366	Clear	£14.50
0000 884 0363	Yellow	£14.50
0000 884 0364	Orange	£14.50
0000 884 0365	Tinted	£14.50

MESH VISOR SET



Lightweight Mesh Visor with Integral Ear Defenders Pivoting Visor Adjustable Head Strap EN 166, EN1731

STIHL®

Part No.	Price
0000 884 0541	£16.90

SAFETY HAT W/CHINSTRAP



c/w V 4 point chinstrap 30mm slot fixing point for attachments. Colour: Black

Part No.	Price
200 416	£11.17

CONTRACTORS SAFETY HATS



High Density Polyethylene Safety Helmet Conforms to EN 397/1995

Part No.	Colour	Price
200 403	White	£9.00
200 404	Yellow	£9.00
200 402	Blue	£9.00

Husqvarna Visors and Accessories

 Husqvarna Please See our Website for more Accessories - www.lsengineers.co.uk

HEARING PROTECT/PERSPEX



Hearing Protection with Perspex Visor. To be used when performing light trimmer work

Part No.	Price
505 66 53 60	£25.98

HEARING PROTECTION



Husqvarna Hearing Protectors with Padded Headband

Part No.	Price
505 66 53 04	£26.72

HEARING/ PERSPEX/ COVER



Hearing Protection with Perspex Visor and Cover Protection for Grass Clearing and other tasks Can be fitted with sun peak

Part No.	Price
505 66 53 48	£39.72

HEARING/ MESH VISOR/ COVER



Husqvarna Hearing Protection with Mesh Visor and Cover

Part No.	Price
505 66 53 58	£39.75

REPLACEMENT VISOR HOLDER



Husqvarna Replacement Visor Helmet Holder

Part No.	Price
505 66 53 28	£13.08

ANTI-FOG VISOR



Husqvarna Anti-fog Visor for Chainsaw Helmet

Part No.	Price
505 66 53 63	£18.07

PERSPEX VISOR



Husqvarna Replacement Perspex Visor Fits Helmet

Part No.	Price
505 66 53 43	£10.10

NYLON MESH VISOR



Husqvarna Replacement Nylon Mesh Visor Fits Helmet

Part No.	Price
599 67 51 01	£11.55

METAL MESH VISOR



Husqvarna Metal Mesh Visor for Chainsaw Helmets

Part No.	Price
599 67 50 01	£11.55

ULTRA VISION VISOR



Husqvarna Ultravision Visor for Chainsaw Helmet

Part No.	Price
574 61 35 01	£20.22

Husqvarna Helmets and Accessories

 Husqvarna Please See our Website for more Accessories - www.lsengineers.co.uk

CLASSIC FOREST HELMET



Helmet completely equipped for forestry or garden work, Includes Metal Mesh Visor and Hearing Protectors

Part No.	Price
580 75 43 01	£45.05

FUNCTIONAL FORESTRY HELMET



Husqvarna Functional Forest Chainsaw Safety Helmet Ultra vision Visor Hearing Protectors

Part No.	Price
576 41 24 02	£67.58

TECHNICAL FOREST HELMET



Technical Forest Chainsaw Helmet Sturdy and Lightweight Hearing Protection, FM Radio, Head Lamp slot

Part No.	Price
585 05 84 01	£117.30

FUNCTIONAL FLUORESCENT HELMET



Husqvarna Functional Forest Helmet - Fluorescent Ultra vision Visor Hearing Protectors

Part No.	Price
576 41 24 01	£65.85

TECHNICAL ARBORIST HELMET



Technical Arborist Chainsaw Helmet. Ventilated Helmet Unique Harness Adjustment Only for working at a height

Part No.	Price
578 09 23 01	£91.50

ADJUSTABLE CHIN STRAP



Husqvarna Adjustable Chin Strap for Pro Forest Helmet. To fit H200, H300 Helmets

Part No.	Price
582 17 04 01	£5.05

NECK GUARD TECH HELMET



Husqvarna Neck Guard fits Husqvarna Technical Helmets, Suitable for OEM No. 585 05 84 01, 578 09 23 01

Part No.	Price
581 75 43 01	£19.98

NECK GUARD



Husqvarna Neck Guard fits Husqvarna Functional Helmets, Suitable for OEM No. 576 41 24 02, 576 41 24 01

Part No.	Price
505 66 53 06	£4.32

SUN PEAK VISOR - FORESTRY



Husqvarna Sun Peak Visor for Chainsaw Forest Helmets

Part No.	Price
578 17 98 01	£4.32

SUN PEAK VISOR - TECHNICAL



Husqvarna Sun Peak Visor V300 (Technical Helmet)

Part No.	Price
581 50 82 01	£5.83

HEARING PROTECTION



Husqvarna Hearing Protection Common Helmet Set

Part No.	Price
505 66 53 25	£24.55

HEARING PROTECTION - TECH



Husqvarna Hearing Protection Technical Helmet Set

Part No.	Price
587 44 24 01	£22.05

Workwear & PPE

CHAINSAW SAFETY HELMET



Chainsaw Safety Helmet
Complete With Mesh Visor &
Integral Ear Defenders
Conforms to EN 397/1995
& 89/686/EEC

Part No.	Price
719	£21.98

STIHL CHAINSAW SAFETY HELMET



Stihl Function Basic Chainsaw
Safety Helmet Complete With Mesh
Visor & Integral Ear Defenders
Conforms to EN 352, EN 397
& EN 1731
Ear protection SNR 24

STIHL®

Part No.	Price
0000 888 0810	£44.05

EAR DEFENDERS



Lightweight Ear Defenders
Filled With High-Impact
Polystyrene Acoustic Foam
Conforms to BS EN 352-1:93

Part No.	Price
200 401	£4.25

CONCEPT 24 EAR DEFENDERS



Breathable Metal Headband
Soft Pads For Comfort
SNR 24 (up to 104dB(A))
BS EN 352

STIHL®

Part No.	Price
0000 884 0541	£16.90

FOAM EAR PLUGS



Safe & Easy to Use
Reusable After Washing
Gently Fits into the Ear Canal
BS EN 352
Box of 200 Plugs

Part No.	Price
907 1430	£21.50

RE-USABLE EAR PLUGS

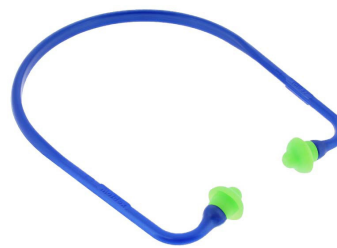

Pura-Band Reusable Ear Plugs -
Head Band Type
Protects from intermittent noise
Durable & washable pods made of
soft thermoplastic

Part No.	Price (ea)
895 211	£5.38

'E-A-RCAPS' EAR PODS



Reusable Protection for
Workers Exposed to
Continuous Noise
Slow Recovery Foam
BS EN 352

E-A-R

Part No.	Price (ea)
200 471	£5.60

E-A-R ULTRAFIT EARPLUGS



Reusable Corded Earplugs
Recommended for Permanent
Protection
BS EN 352

E-A-R

Part No.	Price (ea)
200 472	£2.44

MOLDEX EARPLUG DISPENSER



Moldex 35 dB(A) Ear Plugs
Complete with Dispenser
Contains 250 Pairs

MOLDEX
Moldex 35dB(A) Ear Plugs

Part No.	Price
895 390	£60.83

Health & Safety

FIRE SAFETY STICK



50 & 100 Second Fire Safety Stick

Certified for 5 fire classifications, A-Flammable solids, B-Flammable liquids, C-Flammable gases, Electrical up to 100,000v, and F-Cooking oils and fats

Part No.	Type	Price
500 550	50 Seconds	£69.27
500 100	100 Seconds	£93.20
500 555	50 Seconds with Sticker	£75.58
500 105	100 Seconds with Sticker	£98.40

DUST MASK FFP1



General Purpose Dust Mask FFP1 - Each

Protects Against Non Toxic Dust & Fumes

Part No.	Price (ea)
8710	NLA

DUST MASK FFP2



General Purpose Dust Mask FFP2 (S)
Protects Against Fine Toxic Dust, Fibres & Aqueous Mists

Part No.	Price (ea)
8810	POA

PAINT SPRAY MASK FFP2V



Single Use Mask FFP2V (SL) with Valve

Suitable for Paint Spray Use

Part No.	Price (ea)
8709	POA

RESPIRATORY MASK



Twin Half Mask Respirator Supplied with A1 cartridges

Conforms to EN140:1998 and EN14387:2004

Part No.	Description	Price
SCAPPERESPA1	Mask	£47.08
SCAPPECARTA1	A1 Gas Filter Disc (pair)	£23.51
SCAPPECARTP2	P2 Particle Filter Disc (pair)	£17.08

POWDER FIRE EXTINGUISHERS



Ideal for Cars, Vans, Workshops
Safe on Electrical Fires, Flammable Liquids & Gases
Easy to Handle
Compact & Portable
Fixing Bracket Included
Refillable

Part No.	Size	Price
907 1350	0.6kg	£18.13
907 1351	1.0kg	£19.74
907 1352	2.0kg	£22.95
907 1353	6.0kg	£43.33

FOAM FIRE EXTINGUISHERS



Recommended for Oil & Petrol Fires
Conforms to BS5423
Easy to Handle
Compact & Portable
Fixing Bracket Included
Refillable

Part No.	Size	Price
907 1360	1 Litre	£27.50
907 1361	2 Litre	£36.05

FIRE BLANKET



1.1 x 1.1m Fire Blanket
Compact & Simple To Use
Wall Mounted
Conforms to BS EN 1869

Part No.	Price
907 1365	£18.10

FIRE BUCKET



Plastic, 2 Gallon Fire Bucket with Lid

Wall Mountable

Part No.	Price
907 1368	£28.95

FIRE ALARM BELL



Rotary Hand Operated Fire Alarm bell

Part No.	Price
302 495	£67.84

Health & Safety

FIRST AID KIT - HOUSEHOLD



First Aid Kit 1-10 Person
1 x Guidance note
4 x Non woven triangular bandages
2 x Large sterile dressing
6 x Medium sterile dressing
2 x Sterile eye pad dressing
20 x Assorted waterproof plasters
6 x Alcohol free cleansing wipes
1 x Pair of disposable vinyl gloves
6 x Safety pins

Part No.	Price
895 281	£8.50

BUM BAG FIRST AID KIT



Bum Bag First Aid Kit:
1 x Guidance Leaflet
1 x Vinyl Gloves
1 x Large Dressing
4 x Medical Wipes
2 x Triangular Bandages,
20 x Assorted Washproof Plasters
1 x Resuscitation Shield
6 x Safety Pins

Part No.	Price
200 855	£9.29

FIRST AID KIT - PSV



Medical PSV First Aid Kit
1 x Guidance note
2 x Conforming bandage
1 x Conforming bandage
3 x Large sterile dressing
2 x Sterile eye pad dressing
30 x Assorted waterproof plasters
10 x Alcohol free cleansing wipes
1 x Pair of disposable vinyl gloves
12 x Safety pins
1 x Tuffcut scissors
2 x Non woven triangular bandages

Part No.	Price
895 276	£9.58

EYE WASH STATION



Eye Wash Station
2 x 500ml Solution Bottles
2 x No16 Eye Bandages
For Washing Out Foreign Bodies
Built-in Mirror
Instruction Label

Part No.	Description	Price
200 545	Eye Wash Station	£13.58
200 546	500ml Eye Wash Solution	£1.91
200 547	250ml Eye Wash Solution	£2.04
200 548	20ml Eye Wash Solution	£0.41

FIRST AID KIT - 50 PEOPLE



50 Person First Aid Kit
1 x Guidance note
8 x Non woven triangular bandages
4 x Large sterile dressing
12 x Medium sterile dressing
6 x Sterile eye pad dressing
60 x Assorted waterproof plasters
20 x Alcohol free cleansing wipes
3 x Pair of disposable vinyl gloves
12 x Safety pins

Part No.	Price
895 275	£21.37

RESUCIADE

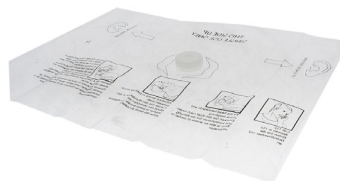

Disposable Resuscitation
Face Shield with One Way
Valve

Part No.	Price
200 550	£1.20

Health & Safety

ANTI INFECTION KIT



Protects the First Aider from Cross Infection
Kit Contains:
Face Shield, PVC Apron, Vinyl Gloves, Cleansing Wipe, Bio Hazard Disposable Bag

Part No.	Price
200 549	£6.70

WOUND CLEANING WIPES



Alcohol Free Wound Cleaning Wipes
Box of 100

Part No.	Price
895 223	£11.82

MEDI-WIPES - TUB OF 100



Disinfectant Drum Wipes Are Ideal For Cleansing Hard Surfaces In First Aid Treatment Areas
100 Wipes

Part No.	Price
200 551	£3.98

ACCIDENT REPORT BOOK



For Recording Details Of Medical Incidents, First Aid Treatment, & Persons Involved

Part No.	Price
200 556	£3.61

STERILE DRESSINGS



Sterile, BPC Cotton Lint Dressings
Ideal for Restocking First Aid Boxes

Part No.	Description	Price
200 553	No.7 Finger Dressing	£1.20
200 554	No.8 Medium Dressing	£1.30
200 555	No.9 Large Dressing	£0.90
200 552	No.3 X-Large Dressing	£1.43

'YOUR FIRST AIDERS ARE' SIGN



'Your First Aiders Are' Signs
400mm x 300mm

Part No.	Description	Price
200 960	Semi Rigid	£11.50
200 961	Self Adhesive	£9.50

PLASTER DISPENSER



Salvequick plaster dispenser
Complete with 40 x Fabric & 45 x Washproof Plasters

Part No.	Description	Price
200 850	Plaster Dispenser	£27.47
200 852	Fabric Refill (40 plasters)	£5.20
200 931	Washproof Refill (45 plasters)	£4.72

'HEALTH & SAFETY ACT' SIGN



Health & Safety at Work Act Sign - Semi Rigid
400mm x 300mm

Part No.	Price
790 537	£11.50

Health & Safety



Safety, Statutory & Warning Signs

We are able to supply safety and statutory signs to BS5378, warning signs and informational signs custom made to your requirements in a range of materials. A small selection is shown below.

Self Adhesive Vinyl (S/A)

Gloss, flexible PVC with permanent adhesive - ideal for interior use

Semi Rigid Plastic (S/R)

1mm semi rigid plastic - suitable for interior and exterior use

Rigid Foamex (R/F)

3mm rigid foamex - suitable for interior and exterior use

'SITE SAFETY' SIGN



Site Safety Sign
600mm x 450mm

Part No.	Description	Price
790 506	Semi Rigid Plastic	£8.90
790 507	3mm Rigid Foamex	£8.90

'REPORT TO SITE OFFICE' SIGN



All Drivers And Visitors Must Report To Site Office Sign
400mm x 300mm

Part No.	Description	Price
790 510	Self Adhesive	£5.25
790 511	Semi Rigid Plastic	£6.25
790 512	3mm Rigid Foamex	£7.95



400x300

Part No.	Type	Price
907 1400	S/A	£6.25
907 1401	S/R	£6.25
907 1402	R/F	£6.25



400x300

Part No.	Type	Price
907 1405	S/A	£6.25
907 1406	S/R	£6.25
907 1407	R/F	£6.25



400x300

Part No.	Type	Price
907 1410	S/A	£6.25
907 1411	S/R	£6.25
907 1412	R/F	£6.25



400x300

Part No.	Type	Price
907 1420	S/A	£6.25
907 1421	S/R	£6.25
907 1422	R/F	£6.25



400x150

Part No.	Type	Price
790 524	S/A	£4.25
790 525	S/R	£4.90



400x150

Part No.	Type	Price
790 526	S/A	£4.90
790 527	S/R	£4.90



400x150

Part No.	Type	Price
790 522	S/A	£4.90
790 523	S/R	£4.90



400x150

Part No.	Type	Price
790 528	S/A	£4.90
790 521	S/R	£4.90



400x150

Part No.	Type	Price
790 529	S/A	£3.85
790 530	S/R	£8.30



400x150

Part No.	Type	Price
790 531	S/A	£8.30
790 532	S/R	£8.30



400x150

Part No.	Type	Price
790 533	S/A	£6.25
790 534	S/R	£9.00



400x300

Part No.	Type	Price
790 535	S/A	£11.50
790 536	S/R	£11.50

Health & Safety



200x100

NO TOOLS OR EQUIPMENT ARE LEFT IN THIS VEHICLE OVERNIGHT

100x100

QUALITY CONTROL PASSED INSPECTION

Semi Rigid

QUALITY CONTROL AWAITING INSPECTION

Semi Rigid

Part No.	Type	Price	Part No.	Type	Price
790 539	S/A	£3.16	790 538	S/A	£1.30
790 140	S/R	£2.40			

Part No.	Size	Price	Part No.	Size	Price
790 513	300x200	£6.50	790 515	300x200	£6.50
790 514	600x450	£27.07	790 516	600x450	£28.43

STOP/GO POLE



Double Sided
Class 2 Reflective
600mm Dia
Rigid UPVC Plate
1.5 Metre Pole

Part No.	Price
300 650	£56.17

RIBBED SAFETY MATTING

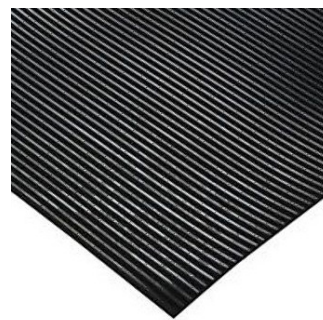

Ideal for Workshop Benches, Walkways, Van Floors, Cab Floors etc.

Easily Cut To Length
1000mm Wide x 3mm Thick
Sold per metre

Part No.	Price Per Metre
866 101	£11.30

ELECTRICAL CLEANER



Powerful Spray Clears Contamination Fast Evaporating, Leaves No Residue Removes Dust, Grease, Tar, Dirt & Oil Safe To Use On Most Plastics

400ml Aerosol



Part No.	Price
FX081350	£3.70

ORBIC SAFETY MAT



Heavy Duty Rubber Mat
Anti-fatigue and Anti-slip
Ideal for Large Areas
Easy to Clean
1500mm x 1000mm x 23mm

Part No.	Price
001 308	£41.35

ELECTRICAL SAFETY MATTING



Designed To BS921
Tested to 15,000 volts
For Use Adjacent to High Voltage Equipment
1000mm Wide x 10mm Thick
Sold per metre

Pallet charge applicable for lengths greater than 5 metres.

Part No.	Price Per Metre
866 102	£43.50

CABLE PROTECTOR



Cable/Hose Protector
Single Channel
Width: 60mm
Channel Size: 8 x 6mm
3m Lengths

Part No.	Price
897 100	£48.95

FIRMA SAFETY MAT

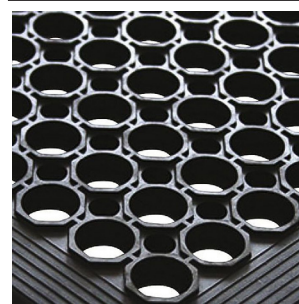

Bevel Edged
Hard Wearing - Made from Oil Resistant Rubber
Easy to Clean
1500mm x 915mm x 15mm

Part No.	Price
001 440	£39.04

Index

1		240v 16Amp Check Plug	E-6	8	
		240v Diesel Pump Kit	D-2		
1 Ton Bag	I-20	240v Extension Leads	E-2	8-Core Trailer Cable	A-6
1-Leg Chain Slings	C-3	240v Hand Lamps	E-8	800kg Rope Hoist	C-9
1" Water Pump Spares	B-1	240v, 16/32 Amp Plugs	E-5	8mm Lifting Chain	C-2
1/2" Drive Socket Sets	G-2	24N Plugs & Sockets	A-5		
1/2" Drive Torque Wrench	A-25	24v Beacons	A-38	9	
1/2" Garden Hose	B-17	24v Combination Lamp	A-3		
1/4" Drive Socket Sets	G-2	24v Diesel Pump Kit	D-2	966 Battery	E-9
1/4" Quick Connector	B-30	24v Gauges, Dashboard	A-41		
10mm Lifting Chain	C-2	24v Marker Lamp	A-2	A	
10W/40 Engine Oil	D-5	24v Relays	A-36		
110v 16Amp Check Plug	E-6	24v Trailer Plugs & Sockets	A-5	Abracs Diamond Blades	I-33
110v Diesel Pump Kit	D-2	24v Washer Pump	A-48	Abrasives, Husqvarna	I-32
110v Electrical Cable	E-3	24v Work Lamp	A-4	Abrasive Discs	I-33, I-34
110v Extension Leads	E-2			Absorbent Granules	D-14
110v Hand Lamps	E-8	3		Absorbent Pads	D-14
110v Plugs & Sockets	E-5			Absorbent Roll	D-14
12-Core Trailer Cable	A-6	3-Core Electrical Cable	E-3	Absorbent Socks	D-13
12" Diamond Blades	I-33	3-in-1 Oil	I-58	Abus Padlocks	I-10
1200HL Heater Spares	F-6	3-Leg Pullers	G-29	Accessories, Helmet	J-11
12N Trailer Plugs & Sockets	A-5	3-Ton Towing Bracket	A-8	Accessories, Husqvarna	J-11
12v Beacons	A-38	3-Way Adapter, Electrical	E-6	Accident Book	J-16
12v Combination Lamp	A-3	3-Way Adaptor Plug	E-1	Acetylene Regulator	I-50
12v Diesel Pump Kit	D-2	3.5-Ton Towing Bracket	A-8	ACME Screw Driver	G-9
12v Gauges, Dashboard	A-41	3/8" Drive Socket Sets	G-2	Acme Screws, Assorted	H-21
12v Marker Lamp	A-2	32 Amp Electrical Cable	E-3	Acrylic Spray Paint	I-30
12v Relays	A-36	3200kg Rope Hoist	C-9	Adaptor, 7-Pin to 13-Pin	A-5
12v Rocker Switch	A-4	3ft Trailer Board	A-1	Adaptor, Brass	B-11
12v Switches	A-36	3kVA Transformer	E-6	Adaptor, Cigarette Lighter	A-41
12v Trailer Lighting	A-2			Adaptor, Diamond Core	G-20
12v Trailer Plugs & Sockets	A-5	4		Adaptors, Impact Socket	G-5
12v Tyre Pump	A-24			Adaptors, Pressure Washer	B-29
12v Washer Pump	A-48	4-Leg Chain Slings	C-3	AdBlue Equipment	D-19
12v Work Lamp	A-4	4-Stroke Oil	D-5	Adblue Hose	B-19
13 Amp Plugs & Sockets	E-1	4-Way Socket, 13 Amp	E-1	Adblue Pump	D-19
13-Pin (Euro) Adaptor	A-5	415v Plugs & Sockets	E-5	Adhesive, Mirror	A-46
13-Pin Trailer Plug/Socket	A-5	4ft Trailer Board	A-1	Adhesives & Glues	I-53
13mm Lifting Chain	C-2	4x4 Explorer Blades	I-33	Adjustable Height Bracket	A-9
1400 Dustbin Heater	F-6			Adjustable Peg Spanner	I-35
16 Amp Electrical Cable	E-3	5		Adjustable Spanners	G-1
16 Amp Fly Leads	E-2			ADR Driver Kit	A-42
1600kg Rope Hoist	C-9	5-lever Deadlocks	I-12	Air Bags, Drain	B-27
1616 Gas Lantern	F-6	5-Ton Towing Bracket	A-8	Air Compressors	I-43
		50mm Load Straps	C-13	Air Duster	I-59
		50mm Tow Ball	A-7	Air Engraver	G-36
		5kVA Transformer	E-6	Air Hose	B-20
		5W/30 Engine Oil	D-5	Air Hose Reels	I-44
2				Air Line Gauge	B-35
				Air Line Hose & Fittings	B-32
2-Core Electrical Cable	E-3			Air Line, Workshop	B-32
2-Leg Chain Slings	C-3	7		Air Pressure Gauge, 12/24v	A-41
2-Ply Paper Roll	I-25			Air Test Kit	B-27
2-Stroke Mixing Bottle	D-16	7-Core Trailer Cable	A-6	Air Tool Kit, 5 Piece	G-36
2-Stroke Oil	D-5	7-Pin Extension Lead	A-6	Air Tools, PCL	B-35
2.1/2" Hydrant Fittings	B-24	7-Pin Plugs & Sockets	A-5	Air Tools, SIP	I-43, I-44
2" Load Straps	C-13	7mm Lifting Chain	C-2		
2" Water Pump Spares	B-1				
24 Hour Plug In Timer	E-1				

Index

Air Valves	B-15	B	Bin Bags	I-20
Airflow Couplings	B-33		Bit Holders, Insert	G-8
Al Oxide Grinder Wheel	I-35	Back Nuts BSP	Bit Set, Bahco	G-9
Alarm, Reversing	A-36, A-37	Backing Pads, Sanding	Bitumen Tools	F-9
Alarm, Smoke	J-15	Backing Spanner	Black Bin Bags	I-20
ALKO Brake Kit	A-17	Backpack Sprayer	Black Iron Fittings	B-14
ALKO Tow Ball	A-7	Bahco Spanners	Black Pallet Wrap	I-19
All Thread Connectors	H-15	Ball Ended Allen Keys	Black Rubber Cable	E-3
Allen Head Screws	H-2	Ball Hitch	Blacksmith Drills	G-11
Allen Keys	G-6	Ball Paint Markers	Blade Flange, Grinder	I-35
Alligator Saws	G-39	Ball Pein Hammers	Blade Fuse Holder	A-4
Alloy Blow Gun	G-36	BALS, 16/32 Amp Plugs	Blade Fuses	A-32
Allthread	H-3	Banding, Polypropylene	Blade Fuses, Assorted	H-23
Aluminium Epoxy Stick	I-54	Banding, Signfix	Blade/Bolt Spanners	G-2
Aluminium Paint	I-30	Banding, Steel	Blades, Diamond	I-33
Aluminium Plates, Fleet	I-19	Barn Type Tool Box	Blades, Hacksaw	G-21
Amber Beacons	A-38	Barrel Bund	Blades, Husqvarna	I-32
Amber Warning Lamp	A-35	Barrel Chain Sling	Blades, Jigsaw	G-20
Ammeter, 12/24v	A-41	Barrel Nipples, Malleable	Blades, Stanley	G-22
Anaerobics, FIXT	I-54	Barrel Pump, Patay	Blanking Cap, Brass	B-11
Anchor Bolts	H-14	Barrel Pump, Rotary	Blanking Cap, Test Plugs	B-27
Anchors, Fixing	H-14	Barrel Pumps	Blanking Caps, Malleable	B-14
Angle Clamp, Welding	I-46	Barrel Taps	Blanking Grommets	E-12
Angle Gate Valve	D-1	Barrier Chain & Fencing	Block & Tackle	C-7
Angle Grinder, Corded	G-39	Barrier Cream	Block Paving Mallet	G-33
Angle Grinder, Cordless	G-40	Barrier Tape	Blow Gun, PCL	B-35, G-36
Angle Grinders	G-39	Barrow Wheels	Blow Out Gun, Air	I-44
Angle Iron, Assorted	H-26	BARS Stop Leak	Blow Out Pump	H-15
Anti Freeze Tester	A-26	Barton Storage Bins	Blowgun, PCL	B-36
Anti Infection Kit	J-16	Base Frame, Patay DD120	Blowtorch Kits, Roofing	F-4
Anti Spatter Spray	I-52	Batteries	Blue Castor Wheels	I-6
Anti-Fog Visor	J-11	Battery Accessories	Blue Electrical Cable	E-3
Anti-Luce Catches	A-20	Battery Chargers	Blue Hose, Layflat	B-9
Anti-Seize Spray	I-58	Battery Condition Gauge	Blue Rope	A-18
Anti-Slip Tape	I-15	Battery Retainers	Blues Liquid Gasket	I-55
Apron, Rubber	J-7	Battery Terminals	Board Bands, Scaffold	G-41
Apron, Welding	I-48	Battery Tester	Body Filler	A-55
Arbors, Hole Saw	G-19	Bauer Couplings	Body Warmers	J-3
Arbourist, Helmets	J-12	BE45 Pump Spares	Boilersuits	J-3
ARC Welders	I-45	Beacon Bar	Boiling Rings, Propane	F-5
Arc Welding Accessories	I-48, I-49	Beacon Bar, LED	Bolster Chisel	G-31
Arctic Cable	E-3	Beacons	Bolt Croppers	G-25
Argon Regulator	I-50	Beam Clamps	Bolt, Spring	A-21
Arm, Vehicle Mirror	A-46	Bearings, Knott Wheel	Bolts & Setscrews	H-1
Armoured Hose, Gas	F-1	Bell, Fire Alarm	Bolts, Hardware	I-1
Asphalt Diamond Blades	I-33	Belle Mixer Conversion Kits	Bolts, Number Plate	A-6
Assorted Boxes	H-16	Bellows, Knott	Bonded Washers	H-13
Assorted Packs & Boxes	H-16	Belt, Floor Sander	Bonnet Catch	A-20
Auto Bulbs	A-34	Bench Grinder	Bonnet Stay, Telescopic	A-21
Auto Cable	A-29, E-4	Bench Grinder Wheels	Boots, Safety	J-5, J-6
Auto Electrics	A-36	Bench Vices	Boots, Wellington	J-7
Auto Fuses	A-32	Bent Nose Pliers	Bosch Power Tools	G-39
Auto Shade Helmet	I-46, I-47	Bib-n-Brace Trousers	Bosch, Wiper Blades	A-47
Automatic Centre Punch	G-29	Big Wipes	Bottle Jacks	A-23
Aviation Snips	G-30	Bike Security Chain	Bottle Key, Gas	I-52
Axle Stands	A-23	Bike Washers	Bottle Trolley, Propane	F-8

Index

Bow Saw	G-21	Builders Bucket	G-35	Cam & Groove Couplings	B-12
Bow Shackles	C-5	Bulb (Auto) Holder	A-33	Camera Batteries	E-10
Brace, Corner, Trailer	A-18	Bulb Kits, Auto	A-35	Camera Kits, Reversing	A-46
Braces, Stihl	J-2	Bulb, Halogen Floodlight	E-9	Camlock Couplings	B-12
Bracket, 7-Pin Socket	A-5	Bulb, Trailer Lamp	A-2	Canopy Door Handle	I-3
Bracket, Marker Lamp	A-2	Bulbs, 240v	E-9	Canopy Lock	A-21
Bracket, Mirror Arm	A-46	Bulbs, Auto	A-34	Canteen Supplies	I-24
Bracket, Trailer Adjusting	A-9	Bulk Grease	D-4	Cantilever Toolboxes	G-36
Brackets, Jockey Leg	A-15	Bulk Rags	I-21	Canvas Air Bags, Drain	B-27
Bradex Easy Start	I-56	Bulk Rope	A-18	Cap Head Screws	H-2
Bradley Towing Bracket	A-8	Bulk String	I-20	Cap, Tyre Valve	A-24
Bradley, Hydraulic Dampers	A-10	Bulldog Wheel Clamps	A-22	Cap/Tail, Brass	B-11
Braided Fuel Pipe	D-17	Bullet Terminals	A-30	Car Body Filler	A-55
Braided Hose	B-18	Bullfinch Burners	F-3	Car Heater Hose	B-20
Brake & Clutch Cleaner	I-59	Bullfinch Spares	F-4, F-5	Caravan Moving Bar	A-7
Brake Adjusters, Knott	A-14	Bumper Protector	A-7	Carb Cleaner	I-59
Brake Nuts	A-53	Bund, Drum	D-11	Carbine Hooks, Untested	C-10
Brake Nuts, Assorted	H-22	Bungee Straps	A-18	Carbiner Hooks, Fall Arrest	J-4
Brake Shoe Kits, Trailer	A-17	Burner, Road, Gas	F-9	Carbon Monoxide Alarm	J-15
Brake Tubing	A-53	Burner, Tar Boiler	F-8	Cardboard Labels	I-19
Brass Fittings	B-11	Burners, Gas	F-3	Cardboard Storage Boxes	I-9
Brass Olives, Assorted	H-29	Butane Cabinet Heater	F-5	Carpet Shampoo	I-59
Brass Padlocks	I-10	Butane Regulators	F-2	Carpet Tape	I-14
Brass Pipe Couplings	B-23	Butt Connectors	A-30	Carrier, Battery	A-28
Brass Screws, Assorted	H-17	Button Batteries	E-10	Cash Box	I-13
Brass Stencils	I-28	Button, Horn	A-37	Cast Eyes	A-11
Brass Valves	B-15	Buzzer, 12v	A-36	Cast Iron Strainer	B-9
Brass Water Nozzles	B-16	Bypass Shears	G-34	Cast Leg	A-13
Brazing Burner	F-3			Castellated Nut, Knott	A-14
Brazing Flux	I-51	C		Castor Wheels	I-5
Brazing Rods	I-51	C Hooks, Lifting	C-4	Castor Wheels, Vacuum	I-40
Breakaway Cable	A-9	C-Clamp	G-26	Catches, Trailer	A-20
Breaker, Push Button	E-10	C-Fold Towels	I-25	Caulking Gun	I-55
Brenton Bolts	I-2	Cabin Deadlocks	I-12	Caution Markers	G-42
Brick Bolster Chisel	G-31	Cabin Hooks	A-21, I-3	Cell Batteries	E-10
Brick Lines	G-37	Cable & Plug, Numatic	I-41	Cement Mixer Conversion Kits	D-18
Brick Nets	C-12	Cable Clips, Assorted	H-28	Cement, Tyre Repair	A-25
Brigade Hydrant	B-24	Cable Clips, Electrical	E-11, E-12	Centre Punch	G-29
Broaching Cutters	G-12	Cable Connector	E-3	Centrefeed Paper Roll	I-25
Broom Head	I-22	Cable Glands	E-13	Ceramic Drill Bits	G-15
Brush, Bench Grinder	I-36	Cable Installing System, Cobra	B-25	Chain Blocks	C-8
Brush, Chimney Sweep	B-27	Cable Lugs	A-27	Chain Post	G-42
Brush, Drain	B-27	Cable Plug, Arc Welding	I-49	Chain Slings	C-3
Brush, Sweeping	I-22	Cable Protector, Floor	J-18	Chain Spray	I-58
Brush, Vehicle Wash	A-50	Cable Pullers	C-8	Chain, Galvanised	C-6
Brush, Wire	G-29	Cable Stripping Tool	A-31	Chain, Lifting	C-2
Brushcutter Trousers	J-2	Cable Ties	E-11	Chain, Security	I-13
Brushes, Tar	F-9	Cable Twin Core	E-4	Chainsaw Clothing	J-2
BSF Hand Taps	G-17	Cable, Auto	A-29, E-4	Chainsaw Gloves	J-8, J-9
BSP Hand Taps	G-17	Cable, Electrical	E-3	Chainsaw Helmets	J-13
BSW Hand Taps	G-17	Cable, Single Core	E-4	Chainsaw Safety Glasses	J-9
Bucket, Mop	I-22	Cable, Speaker	E-4	Chainsaw, Helmets	J-12
Bucket, Vehicle Wash	A-50	Cable, Starter	E-4	Chalk Line Reel	G-37
Buckets	G-35	Cable, Trailer	A-6, E-4	Chamois Leather	A-50
Budget Locks	A-21			Changeover Kit, Propane	F-3
Buffer, Rubber	A-1				

Index

Changeover Switch	E-10	Cloth Filter, Vacuum	I-39	Corded Power Tools	G-39
Chargers, Li-Ion	G-40	Cloth, Vehicle Wash	A-50	Cordless Power Tools	G-40
Check Plug, 110v / 240v	E-6	Clothing, Footwear	J-5, J-6	Core Drilling Bits	G-20
Check Plug, 13 Amp	E-1	Clothing, Safety	J-1	Cork Gasket Sheet	I-26
Checkpoint Indicators	A-24	Cloths, Cleaning	I-21	Corner Brace, Trailer	A-18
Chemical Anchors	H-15	Club Hammers	G-32	Cotter Pin	A-20
Chemical Lance	B-30	Clutch Springs	H-27	Cotter Pin & Chain	I-4
Chemical Spill Kits	D-12	CO2 Regulator	I-50	Cotter Pins	H-9
Chemical Spray Bottle	I-59	Coach Bolts	H-2	Cotton Braided Hose	B-18
Chemico Grinding Paste	G-37	Coal Shovel	I-22	Cotton Dust Sheet	I-27
Chevron Tape	I-15	Coat, High-Vis	J-1	Cotton Mop Heads	I-22
Chevrons, Self Adhesive	A-43	Cobalt Jobber Drills	G-10	Cotton Rags	I-21
Chewing Gum Remover	I-59	Cobra Rodding System	B-25	Cotton Rags, White	A-50
Chimney Sweep Brush	B-27	Cobra Security Cables	I-13	Countersink Bits	G-12
Chin Strap, Helmets	J-12	Cobra TT 2-Stroke Oil	D-5	Countersunk Screws	H-12
Chisels, Builders	G-31	Cockpit Shine	A-50, I-59	Couplings, Pipe	B-23
Chocks, Wheel	A-23	Coffee	I-24	Couplings, Pressure Washer	B-29
Chok-A-Blok Webbing Guard	C-13	Coffee Mate	I-24	Cover, Towing Hitch	A-7
Chucks & Chuck Keys	G-15	Cold Chisel & Punch Set	G-29	Cover, Windscreen	A-49
Cigarette Lighter Plug/Socket	A-37	Cold Chisel, Builders	G-31	Covers, Trailer	A-18
Circlips	H-7	Collared Eye Bolts	C-6	Crayon, Wax	A-25
Circlips, Assorted	H-19	Combi Drill, Cordless	G-40	Cream, Hand	I-23
Circuit Breaker, RCD	E-1	Combination Lamp, Rear	A-3	Creeper Board, Mechanics	I-9
Circuit Breakers	E-10	Combination Padlocks	I-10	Crevice Tool, Henry Hoover	I-42
Clack Valve, Wickham	B-8	Combination Spanners	G-1	Crimp Terminals	A-30
Clamp, Earthing	I-49	Combination Squares	G-27	Crimping Pliers	A-31
Clamps, Beam	C-8	Commando Socks	J-7	Crimping Pliers, Ratchet	C-11
Clamps, Exhaust	A-52	Compartment Organiser	G-35	Cro-Mo Sockets	G-3
Clamps, Jockey Wheel	A-13	Component Connectors	C-4	Crocodile Clips	A-41
Clamps, Self Gripping	G-26	Composite Panel Screws	H-13	Croppers, Bolt	G-25
Clamps, Toggle	A-20, I-3	Compression Springs, Assorted	H-26	Cross Pein Hammers	G-32
Clamps, Welding	I-48	Compressor, Tyre 12v	A-24	Crow Bars	G-31
Class I Protective Clothing	J-2	Concave Vehicle Mirror	A-45	Cup Brushes	I-36
Claw Hammers	G-32	Concrete Blades, Diamond	I-33	Cup Stones	I-35
Cleaning Cloth	I-21	Concrete Screws	H-12	Cut-Off Saw Blades	I-32, I-33
Clear Adhesive Tape	I-14	Concrete Test Moulds	G-38	Cutting & Grinding Discs	I-33
Clear Boxes, Assortments	H-25	Conditioning Cream	I-24	CV Joint Grease	D-4
Clear Braided Tubing	B-18	Cone Cutters	G-12	Cylinder Honers	G-28
Clear Film, Stretch	I-18	Connector, Grease Gun	D-3	Cylinder Trolleys	I-52
Clear Lacquer	I-30	Connectors, High Current	A-35		
Clear Liquid Gasket	I-55	Contact Adhesive	I-54	D	
Clear Pallet Wrap	I-19	Contact Tips, MIG	I-52	Dairy Steam Hose	B-21
Clear Plastic Bags	I-20	Container Lock	A-22	Daishin Pump Spares	B-3
Clear Tubing, Washer	A-48	Continental Fuses	A-32	Dangerous Goods, ADR Kit	A-42
Clear Wallers	I-31	Continuous Hinge	I-1	Dashboard Indicator Lamp	A-35
Clearing Wheel, Drain	B-27	Control Box	E-13	DC400 Wheel Clamp	A-22
Clevis Hooks, Lifting	C-4	Conversion Kit, Mixer	D-18	DD120 Pump Spares	B-7
Clevis Pins	H-9	Convex Vehicle Mirror	A-45	De-Icer	A-49
Clip-On Tyre Connector	B-36	Cooling System Hose	B-20	Debris Nets	C-12
Clip, Number Plate	A-6	Coping Saw	G-21	Deburring Bits	G-12
Clipper Diamond Blades	I-33	Copper Brake Pipe	A-53	Decorating Tools	I-27
Clips, Road Sign	I-16	Copper Electrical Cable	E-3	Dee Shackles	C-5
Clips, Signfix Banding	I-16	Copper Grease	D-4, I-58	Dee Shackles, Untested	C-10
Closed Shackle Padlocks	I-11	Copper Hammers	G-32	Deep Drip Tray	D-10
		Copper Washers, Assorted	H-18		

Index

Deep Impact Sockets	G-5	Double Bubble Epoxy	I-54	Edge Protectors, Strapping	I-17
Deep Sockets	G-3	Double Leg Chain Slings	C-3	Edge Trim	I-2
Degreasing Fluids	I-57	Double Sided Tape	I-14	Elbow, Malleable	B-15
Deionized Water	A-28	Double Step	I-9	Elbow, Washer	A-48
Delivery Hose, Layflat	B-9	Dowty Washers, Assorted	H-19	Electrical Cable	E-3
Delta Sanding Discs	I-37	Drain Filters	D-8	Electrical Cleaner	I-59
Demolition Bars	G-31	Drain Pans, Oil	D-7	Electrical Matting	J-18
Detection Strips	D-8	Drain Rods & Fittings	B-26	Electrical Pliers	G-23
Dewatering Filter	D-8	Drain Testing Kits	B-27	Electrical PVC Conduit	E-13
Diagonal Cutters	G-23	Draw Tubes	A-12	Electrical Tape	E-11, I-15
Diamond Blades	I-32, I-33	Dressings, Sterile	J-16	Electrodes, Welding	I-49
Diamond Core Bits	G-20	Drill Bits, Diamond Core	G-20	Elite-Cut Blades	I-32
Diamond Glass & Tile Bits	G-15	Drill Chucks	G-15	Emergency Hammer	G-37
Diamond Warning Signs	A-44	Drillaparot Tie Puller	I-21	Emergency Stop Button	E-13
Diaphragms, Pump	B-8	Drills, Electric	G-39	Emery Cloth	I-38
Die Grinder Set, Air	I-44	Drills, Jobber HSS	G-10	End Cutters	G-23
Die Sets	G-17	Drills, Masonry	G-13	Engine Cleaning Brush	G-29
Die Stocks	G-18	Drip Tray, Drum	D-14	Engine Flush	I-56
Dies & Die Nuts	G-18	Drip Trays	D-9	Engine Hour Meter	A-41
Diesel & Fuelling Equipment	D-1	Drive Converters, Socket	G-4	Engine Lacquer	I-30
Diesel Filter, 1" BSP	D-2	Drive Rails, Socket	G-4	Engine Oil	D-5
Diesel Hose	D-1	Drop Scraper, Drain	B-26	Engineers, Files	G-30
Diesel Pump, Patay	B-7	Drum Dollies	D-16	Engraver, 240v	G-37
Diesel Transfer Pump, Hand	B-8	Drum Drip Tray	D-14	Engraver, Air	B-35, G-36
Diesel treatment	I-56	Drum Funnel	D-14	Enviropads	D-8
Digital Card Reader, Tacho	A-51	Drum Spill Containment	D-10	EP2 Grease	D-4
Digital Flow Meter, Fuel	D-1	Drum Toppers	D-13	EP90 Oil	D-5
Digital Multimeter	G-24	Drum Winches	A-19	Epoxy Adhesives	I-54
Digital Vernier	G-27	Dry Wipe Pens	I-29	Equal Tees, Malleable	B-14
DIN Mounted Beacons	A-38	Dry Wipe Whiteboards	I-29	Equaliser Bars	A-10
DIN Plug/Socket	A-37	Drywall Saw	G-21	EU Marker Boards	A-42
DIN Spigots	A-39	Duck Oil	I-58	Euro Plugs & Sockets	A-5
Dinghy Pump, Patay	B-7	Duck Tape	I-14	Evo Stik Impact Adhesive	I-54
Disc Cutter Blades	I-32	Duct Tape	I-14	Exhaust Accessories, Vehicle	A-52
Discus Padlocks	I-11	Duplex Webbing Slings	C-1	Exhaust Paper	I-26
Dish Cloths	I-21	Duracell Batteries	E-10	Exhaust Repair Paste	I-56
Dispenser, Barrier Cream	I-24	Durite Battery Charger	A-26	Exit Signs	J-17
Dispenser, Gloves	J-8	Durite Multimeter	G-24	Expanding Foam	I-55
Dispenser, Hose Clips	B-22	Dust Bags, Henry Hoover	I-42	Expansion Springs, Assort- ed	H-26
Dispenser, Pallet Wrap	I-19	Dust Cap, Trailer Wheel	A-17	Extension Bars, Socket	G-4
Dispenser, Paper	I-25	Dust Masks	J-14	Extension Cable, 12v	A-37
Dispenser, Poly Strapping	I-17	Dust Sheets	I-27	Extension Lead, 7-Pin	A-6
Dispenser, Steel Strapping	I-18	Dustbin Heater, Bullfinch	F-6	Extension Leads	E-2
Display Rack, Assortments	H-25	Dustbin Spill Kits	D-12	Extension, Diamond Core	G-20
Disposable Gloves	J-8	Dusters	I-21	Extension, Tyre Valve	A-24
Disposable Overalls	J-3	Dustpan & Brush	I-22	External Circlips	H-7
Distance Measuring Wheel	G-27			External Locking Washers	H-7
Distilled Water, Battery	A-28	E		Extruded Seal	I-2
Document Wallets	I-31	E-Clips	H-8	Eye Bolt Anchors	H-14
Dollies, Drum	D-16	E100TC Towing Bracket	A-8	Eye Bolts	C-6, H-15
Dome Nuts	H-5	E40TC Towing Bracket	A-8	Eye Hooks, Lifting	C-7
Door Handle, Canopy	A-21, I-3	Ear Defenders	J-13	Eye Nuts	C-6
Door Lock, Yale	I-13	Ear Plugs	J-13	Eye Protection	J-10
Door Retainers	I-1	Earthing Clamp, Welding	I-49	Eye Protection, Husqvarna	J-9
Door Trim/Seal	I-2	Easy Start, Bradex	I-56		
Dormer Drill Sets	G-11				

Index

Eye Wash	J-15	Flexible Drip Trays	D-9	Funnels	D-16
Eyelock, Trailer	A-7	Flexible Electrical Cable	E-3	Furnace, Bullfinch	F-5
F		Flexible Exhaust Pipe	A-52	Fuse (Auto) Holder	A-33
Face Visors	J-10	Flexible PVC Conduit	E-13	Fuse Holder, Blade Fuse	A-4
Fall Arrest Harnesses	J-4	Flint Lighter	I-51	Fuse Tap & Holder	A-33
Farmers Pack	H-26	Float Gauges, Tank	D-16	Fuses, Assorted	H-23
Fasteners & Fixings	H-1	Float Switch, Pump	B-8	Fuses, Auto	A-32
Fasteners, Assorted	H-16	Flood Lights	E-7	Fuses, Domestic Plug	E-1
Fatigue Matting	J-18	Floor Attachment, Henry	I-42	Fuses, Domestic, Assorted	H-28
Feeler Gauges	G-28	Floor Lamp, Site	E-7		
Female Pump Couplings	B-10	Floor Lashing Ring	A-21	G	
Female Spade Terminals	A-30	Floor Mats, Paper	A-54	G-Clamps	G-26
Fencing Couplers	G-41	Floor Sander Dust Bags	I-42	Gaffer Tape	I-14
Fencing Pliers	G-23	Floor Sanding Belts	I-38	Gaiter Kit, Universal	A-55
Ferrules, Wire Rope	C-11	Floor Saw Blades	I-33	Gaiter Kit, Universal	A-55
Festoon Bulb	A-35	Floor Spray, Line	I-16	Galvanised Chain	C-6, I-13
Festoon Lighting Kit	E-7	Floor Tape	I-15	Gap Filling Foam	I-55
Fibre Sanding Discs	I-37	Flooring Chisel	G-31	Garage Door Handle	I-3
Fibre Washers	H-7	Flowmeter, Fuel	D-1	Garage Funnel	D-16
Files, Engineers	G-30	Fluorescent Interior Lamp	A-3	Garage Handle	A-21
Film, Stretch	I-18	Fluorescent Starters	E-9	Garden Hose	B-17
Filter, Numatic	I-39	Fluorescent Tubes	E-9	Garden Waste Bags	I-20
Filtered Vacuum Bags	I-39	Flux, Brazing	I-51	Garden Tools	G-34
Fire Alarm	J-15	Flux, Soldering	I-53	Gas Bottle Spanner	I-52
Fire Blanket	J-14	Fly Leads	E-2	Gas Cutting Accessories	I-50
Fire Bucket	J-14	Foam Ear Plugs	J-13	Gas Cylinders	F-7
Fire Exit Signs	J-17	Foam Fire Extinguisher	J-14	Gas Hose & Fittings	F-1
Fire Extinguishers	J-14	Foam Paint Roller	I-27	Gas Leak Detection Spray	F-3
Firma Matting	J-18	Foaming Cleaner	I-58	Gas Light Mantles	F-6
First Aid	J-16	Fog Lamp	A-2	Gas PTFE Tape	I-14
First Aid Kits	J-15	Folding Hazchem Plate	A-42	Gas Soldering Kit	G-24
Fisco Tape Measures	G-27	Food Grease	I-57	Gas Spanners	F-8
Fish-Eye Mirror	A-45	Food Quality Hose	B-21	Gas Torch Kits	F-3
Fittings, Brass	B-11	Foot Pump	A-24	Gas Welding Accessories	I-48, I-50
Fixings, Number Plate	A-6	Foot Valve Strainers	B-9	Gas, Regulators	F-2
FIXT Adhesives	I-53	Foot, Trailer, Wind Up	A-18	Gasket Paper	I-26
Flame Retardant Overalls	J-3	Footwear, Safety	J-5, J-6	Gasket Paper, Assorted	H-28
Flammable Sign, Diamond	A-44	Ford Transit Rear Lens	A-3	Gasket Scraper Tool	G-28
Flange, Grinder Blade	I-35	Forestry, Helmets	J-12	Gasket, Liquid	I-55
Flanged Nuts	H-4	Fork Lift Sign	J-17	Gasless MIG Wire	I-53
Flanged Nuts, Barrel	D-16	Fork Terminals	A-31	Gate Bolts	I-2
Flanged Setscrews	H-2	Fork, Garden	G-34	Gate Valves	B-15
Flap Discs	I-34	Form A Washers	H-5	Gauge, Tank	D-16
Flap Wheels	I-37	Form C Washers	H-5	Gauges, Dashboard	A-41
Flaring Tool, Pipe	A-53	Four Leg Chain Slings	C-3	Gauntlets, Welding	I-48
Flashback Arrestors	I-50	Four Stroke Oil	D-5	Gear Oil	D-5
Flasher Unit, 12v	A-36	Frame, Patay DD120	B-7	Gear Oil Pump	D-7
Flashing Beacons	A-38	Freeway Oil	I-58	Geka Type Couplings	B-16
Flat Bar, Assorted	H-26	French Chalk	I-48	Generator Changeover	E-10
Flat Files	G-30	Fuel Additives	I-56	Switch	
Flat Washers	H-5	Fuel Cans	D-17	Generator Electrical Sockets	E-5
Fleet Number Plates	I-19	Fuel Gauge, 12v	A-41	Generator Frame	E-10
Flexi Bucket	G-35	Fuel Hose	B-18	Generator Mounts	E-10
Flexi Handles, Socket	G-4	Fuel Spill Kit	D-12	Generators, Loncin	D-18
		Fuelling Equipment	D-1	Genie Pump Diaphragm	B-8
		Fulton Braked Winches	A-19	Gilbow Tinsnips	G-26

Index

Gin Block	C-7	H4 Bulb Kit	A-35	Helmet Visors, Husqvarna	J-11
Gland Packing, Pump	B-8	H7 Bulb Holder	A-33	Helmet, Welding	I-46, I-47
Glass & Tile Bits	G-15	Hacksaws	G-21	Helmets, Husqvarna	J-12
Glass Auto Fuses	A-32	Had Drill Vice	I-46	Henry Hoover Accessories	I-42
Glass Cleaner	I-58	Half Round Files	G-30	Henry Vacuum Bags	I-39
Glass Fibre Repair Kit	A-55	Halogen Auto Bulbs	A-34	Hessian Sacks	I-20
Glasses, Safety	J-10	Halogen Bulb, Floodlight	E-9	Hessian Sheet	I-21
Gloss Paint Roller	I-27	Halogen Work Lights, Site	E-7	Hessian Sheet, Tarmac	F-9
Gloss Paint, Spray	I-30	Hammer Drills	G-39	Hex Allen Keys	G-6
Gloves	J-7, J-9	Hammer Shafts	H-27	Hex Bushes, Malleable	B-14
Gloves, Husqvarna	J-9	Hammer Wedges	H-28	Hex Insert Bits	G-8
Gloves, Welding	I-47	Hammer, Welding	I-48	Hex Socket Bits	G-5
Glue, Tyre Repair	A-25	Hammers	G-32	HGV, ADR Kit	A-42
Glues & Adhesives	I-53	Hand Brush	I-22	High Current Connectors	A-35
Goggles	J-10	Hand Cleaner	I-24	High Pressure Gas Regulators	F-2
Goggles, Husqvarna	J-9	Hand Cream	I-24		
Grab Hooks, Lifting	C-4	Hand Lamps	E-8	High Voltage Pliers	G-23
Grade 80 Hooks	C-4	Hand Protection	J-7, J-8	High-Vis Clothing	J-1
Grade 80 Lifting Chain	C-2	Hand Pump, Patay	B-5	High-vis Vehicle Tape	A-43
Graffiti Remover	I-59	Hand Pumps, Patay	B-7	Highway Maintenance Sign	A-44
Granit Padlocks	I-11	Hand Saw	G-21	Hilta Pump Diaphragm	B-8
Gravelly Fastener	A-21	Hand Soap	I-23	Hilta Pump Spares	B-3
Grease Cartridges	D-4	Hand Taps	G-16	Hinge, Gudgeon Pin	A-20
Grease Gun End	D-3	Hand Tools	G-1	Hinges, Steel	I-1
Grease Guns	D-3	Hand Towels	I-23	HiPro Gas	F-7
Grease Nipples	D-4, D-6	Handbrake, Trailer	A-12	Hiretech Sander Bags	I-42
Grease, Multipurpose	D-4	Handle, Broom	I-22	Hiretech Sanding Sheets	I-38
Green Beacons	A-39	Handle, Numatic	I-40	Hitch Lock, Trailer	A-7
Green Hose, Pump	B-9	Handle, Patay Pump	B-5, B-6	Hitch, Towing 50mm	A-7
Green Indicator Lamp	A-35	Handle, Pickaxe	G-33	Hoist Control Switch	E-13
Grey Primer	I-30	Handle, Plastic Pull	I-1	Hoist, Lever Ratchet	C-8
Grid, Drip Tray	D-9	Handle, Semi Rotary Pump	B-8	Holder, Blade Fuse	A-33
Grinder Disc Spanners	I-35	Handles, File	G-30	Holder, Hazchem Plate	A-42
Grinder Wheels, Bench	I-35	Hardware	I-1	Holder, Number Plate	A-6
Grinding & Cutting Discs	I-33	Hardware, Trailer	A-20	Hole Digger, Post	G-33
Grinding Paste, Valve	G-37	Harness, Fall Arrest	J-4	Holesaws	G-19
Grip Gloves	J-7	Harris Fencing Tools	G-41	Holts Gun Gum	I-56
Grip Tape	I-15	Hasp & Staples	I-12	Honda 4-Stroke Oil	D-5
Gripper Hand Lamp	E-8	Hazard Warning Diamonds	A-44	Honda Liquid Gasket	I-55
Grommets, Assorted	H-24	Hazard Warning Plate	A-42	Honda Water Pump Spares	B-1
Grommets, Wiring	E-12	Hazard Warning Tape	I-15	Honda Water Pumps	B-4
Groundsheets	C-12	Head Protection	J-10	Honeycombe Tape	A-43
GRP Repair Kit	A-55	Head Tool, Henry Vacuum	I-40	Hook & Loop Discs	I-37
Grub Screws	H-3	Head Tools, Numatic	I-40	Hook & Loop Tape	I-15
GT85	I-57	Headlamps, Personal	E-8	Hook Bolt Anchors	H-14
Guard, Vehicle Lamp	A-3	Health & Safety Sign	J-16	Hook Bolts	H-15
Gudgeon Pins	A-20	Hearing Protection	J-11, J-12	Hook On Connector	D-3
Gun Gum	I-56	Heat Shrink Tubing	E-12	Hook Set, Mini	G-28
Gun, Diesel	D-1	Heat Shrink, Assorted	H-23	Hooks, Lifting	C-4
		Heater Hose	B-18	Horn, 12/24v	A-37
		Heaters, Gas	F-5	Hose & Reg Kit, 1400	F-6
		Heavy Duty Castor Wheels	I-6	Hose & Tubing	B-18
		Heavy Duty Gloves	J-9	Hose Clips	B-22
H07 Electrical Cable	E-3	Hedge Shears	G-34	Hose Clips, Assorted	H-29
H1 Auto Bulb	A-34	Height Indicator, Vehicle	A-43	Hose Clips, Wide Band	B-10
H1 Bulb Holder	A-33	Helicoils	G-18	Hose Reel, Wall Mounted	B-17
H1/H7 Bulb Kit	A-35				

Index

Hose Strainers	B-9	Insert Bits	G-7	Key Storage	I-12
Hose, Diesel 1"	D-1	Insert Locking Nuts	H-4	Key, Container Lock	A-22
Hose, Exhaust	B-19	Inserts, Thread Repair	H-10	Key, Hydrant	B-24
Hose, Fuel	B-19	Inspection Lamps	E-8	Key, Manhole Lifting	B-26
Hose, Gas	F-1	Instant Gasket	I-55	Keyed Alike Padlocks	I-10
Hose, Henry Hoover	I-42	Instantaneous Couplings	B-24	Keyless Chucks	G-15
Hose, Numatic Vacuum	I-39	Instrument Bulb	A-34	Knee Pads, Welding	I-48
Hose, Pressure Washer	B-28	Insulation Tape	E-11	Knives, Stanley	G-22
Hose, Radiator	A-55	Insulation Tape, Electrical	I-15	Knob, Jockey Wheel	A-9
Hose, Water Pump	B-9	Insurance Padlocks	I-11	Knott Brake Shoe Kits	A-17
Hoses, Gas Welding	I-50	Interior Vehicle Lamp	A-3	Knott Couplings	A-10
Hour Meter, Engine	A-41	Interlocking Stencils	I-28	Knott Jockey Wheels	A-15
Hozelock Connectors	B-17	Internal Circlips	H-7	Knott, Bellows	A-12
HP Ultra 2-Stroke Oil	D-5	InterPump Seal Kits	B-29	Knott, Hydraulic Dampers	A-10
HSS Holesaws	G-19	Inverter, 12v - 230v	A-41	Koshin Pump Spares	B-3
HSS Jobber Drills	G-10	Irrigation Couplings	B-16	Krypton Torch Bulb	E-9
HT Setscrews	H-1	Isolator Switch, Battery	A-28	Kubota Grease Nipple	D-4, D-6
HT7 Sander Bags	I-42			Kubota Grease Nipples	D-6
HT8 Sander Bags	I-42	J			
Hub Cap, Knott	A-14	J Nuts	H-5	L	
Husqvarna 2-Stroke Oil	D-5	Jack Saw	G-21	Labels, Cardboard	I-19
Husqvarna Accessories	J-9	Jack, Trolley	A-23	Ladder Clamp Set	G-37
Husqvarna Blades	I-32	Jacks, Hydraulic	A-23	Ladle, Tar	F-9
Husqvarna, Helmets	J-12	JCB Grease Nipple	D-4, D-6	Lamp Guard	A-3
Hybrid, Wiper Blades	A-47	Jerricans	D-17	Lamp Unit, Vehicle	A-3
Hydrant Key	B-24	JET Rope Hoist	C-9	Lamp, Indicator (Dash-board)	A-35
Hydrants & Fittings	B-24	Jet, Windscreen Washer	A-49	Lamp, Trailer Board	A-2
Hydraulic Dampers, Bradley	A-10	Jiffy Bags	I-20	Lamp, Vehicle Interior	A-3
Hydraulic Dampers, Knott	A-10	Jigsaw Blades	G-20	Lamps, Hand	E-8
Hydraulic Jacks	A-23	Jigsaw, Corded	G-39	Lance, Pressure Washer	B-28
Hydrometer	A-26	Jigsaw, Cordless	G-40	Lantern Battery	E-9
Hylomar Exhaust Putty	A-52	Jigsaws	G-39	Lanyard, Tool	J-4
Hylomar Liquid Gasket	I-55	Jizer Degreaser	I-57	Lashing Ring	A-21, C-11
I		Jobber Drills, HSS	G-10	Latex Apron	J-7
Ice Scraper	A-49	Jockey Leg Brackets	A-15	Latex Gloves	J-8
Ifor Williams Storage Box	A-18	Jockey Wheels, Knott	A-15	Layflat Hose	B-9
Impact Sockets	G-5	Jubilee Clips	B-22	Lazy Tong Riveter	H-10
Impact Wrench, Air	B-35, I-43	Jugs, Pouring & Measuring	D-17	Leaf Rake	G-34
Imperial Allen Keys	G-6	Jump Leads	A-27	Leak Detection Spray, Gas	F-3
Imperial Grease Nipples	D-4, D-6	Junction Box, 8-Way	A-5	Leak Detector Spray, Gas	I-52
Imperial Hand Taps	G-16	Junction Box, Rubberlight	A-37	Leak Off Hose	B-18
Imperial Jobber Drills	G-11	Junior Hacksaw	G-21	Leak Off Pipe	D-17
Imperial Spanners	G-1	Jute Sheet, Tarmac	F-9	Leather Washers	B-10
Indicator Bulb	A-34	K		Leather, Chamois	A-50
Industrial Vacuum Hose	B-21	K0 Semi Rotary Pump	B-8	LED Beacons	A-38
Inferno Diamond Blades	I-33	K1 Semi Rotary Pump	B-8	LED Hand Lamps	E-8
Injector Cleaner	I-56, I-59	K2 Semi Rotary Pump	B-8	LED Light Bulbs	E-9
Injector, Chemical	B-30	Karbiner Hooks, Fall Arrest	B-8	LED Interior Lamp	A-3
Ink Stain Remover	I-59	Karcher Hoses & Adaptors	J-4	LED Trailer Boards	A-1
Inline Diesel Filter, 1" BSP	D-2	Karcher Vac Accessories	B-28	LED Trailer Lamp	A-2
Inline Filter, Pressure Washer	B-30	Key Cabinets	I-42	LED Work Lamps	A-4
Inline Fuse Holder	A-33	Key Steel	I-12	LED Work Lights, Site	E-7
Insert Bit Holders	G-8	Key Steel	I-3	Left Hand Nuts	H-5
		Key Steel, Assorted	H-26	Lemon Hand Cleaner	I-23

Index

Letter Punch Sets	I-29	Loncin Generators	D-18	Mechanical Flowmeter	D-1
Letter Stencils	I-28	Loncin Water Pumps	B-4	Mechanics Creeper Board	I-9
Letters, Number Plate	A-6	Long Nose Pliers	G-23	Medi Wipes	J-16
Levels, Spirit	G-28	Long Shank Padlocks	I-10	Mesh Barrier Fencing	G-42
Lever Action Pump	B-8	Loo Roll	I-25	Mesh Face Shield	J-10
Lever Ball Valves	B-15	Loose Bolt Anchors	H-14	Mesh Visors	J-11
Lever Lock Couplings	B-13	Lorry Nets	C-12	Metal Cutting Discs	I-34
Leyland Van Rear Lens	A-3	Low Energy Bulbs	E-9	Metal Drip Trays	D-9
License Holder, Vehicle	A-43	Low Hydrogen Electrodes	I-49	Metal Dustpan	I-22
Lid, 3kVA Transformer	E-6	Low Pressure Gas Regulators	F-2	Metal Mop Bucket	I-22
Lift-Off Hinge	I-1	Lump Hammers	G-32	Metal Number Plate	A-6
Lifting Blocks, Chain	C-8	Lynch Pins	I-4	Metal Plates, Fleet	I-19
Lifting Chain	C-2			Metal Storage Box, Trailer	A-18
Lifting Chain Slings	C-3			Metal Tool Box	G-36
Lifting Strops & Round Slings	C-1	M		Metric Allen Keys	G-6
Light Bar, LED	A-4	Machine Taps	G-16	Metric Grease Nipples	D-4, D-6
Light Bulbs, 240v	E-9	Magnetic Beacons	A-38	Metric Hand Taps	G-16
Light Unit, Vehicle	A-3	Magnetic Floodlights	E-7	Metric Jobber Drills	G-10
Light, Indicator (Dashboard)	A-35	Magnetic Hazchem Plate	A-42	Metric O-Rings	H-8
Light, Trailer Board	A-2	Magnetic Holder, Welding	I-46	Metric Setscrews	H-1
Lighting Module, Trailer	A-1	Magnetic Number Plate	A-6	Metric Spanners	G-1
Lighting, Site	E-7	Magnetic Tools	G-38	Midi Cobra Rodding System	B-25
Linch Pins	I-4	Magnetic Trailer Board	A-1	MIG Welders	I-45
Line Chalk	G-37	Magnetic Work Lamp	A-4	MIG Welding Accessories	I-52
Line Markers	I-16	Maintenance Sprays	I-57	Mild Steel Electrodes	I-49
Line Marking Spray	I-16	Makita Batteries	G-40	Mild Steel Hinges	I-1
Liner, Plant Nappy	D-13	Makita Power Tools	G-39, G-40	Mini Blade Fuses	A-32
Linn Storage Bins	I-9	Male Pump Couplings	B-10	Mini Fuses	A-32
Liquid Gasket	I-55	Male Spade Terminals	A-30	Mini Hook Set	G-28
Liquid Hand Cleaner	I-23	Male/Tail, Brass	B-11	Mini Hose Clips	B-22
Liquid Nails	I-55	Malleable Iron Fittings	B-14	Minimix Conversion Kits	D-18
Lithium Grease	D-4	Mallets	G-33	Mirror Arms	A-46
Lithium-Ion Batteries	G-40	Manhole Lifting Tools	B-26	Mirror Cleaner	I-58
Load Binder Chain	C-2	Manifold Nuts/Studs	A-52	Mirrors, Vehicle	A-45
Load Binders	C-12	Manifold Studs, Assorted	H-22	Mixed Rags	I-21
Load Projection Markers	A-43	Mantles, Gas Light	F-6	Mixer Conversion Kits	D-18
Load Straps	C-13	Manual Changeover Kit	F-3	Mixing Bottle, 2-Stroke	D-16
Loading Bay Rubber Buffer	A-1	Marble Drill Bits	G-15	Mobile Tool Chest	G-36
Lock n Lube Connector	D-3	Marine Hose	B-19	Mop Buckets	I-22
Lock Washers, Assorted	H-18	Markal Paint Markers	G-37	Mop Heads	I-22
Lock, Budget, Square Drive	A-21	Marker Boards	A-42	Mortice Deadlocks	I-12
Lock, Container	A-22	Marker Lamps	A-2	MOT Holder	A-43
Lock, Toolbox	A-21	Marking Spray, Line	I-16	Motorway Maintenance Sign	A-44
Lock, Tow Ball	A-7	Mask, Welding	I-47	Mould Release Oil	G-38
Lockable Gate Valve	D-1	Masking Tape	I-14	Mount, Generator	E-10
Lockfast Drain Rods	B-26	Masks, Dust	J-14	Mounting Bracket, 7-Pin	A-5
Locking Handles, Jockey Wheel	A-12	Masonry Anchors	H-14	Mounting Tool, Valve	A-24
Locking Nuts	H-4	Masonry Drills	G-13	Moving Bar, Caravan	A-7
Locking Pliers	G-26	Masonry Screws	H-12	Mud Wings, Trailer	A-16
Locking Washers	H-6	Master Links, Lifting	C-4	Multi Function Vehicle Lamp	A-3
Locking Wire	C-11	Mats, Spill	D-10	Multi-Fix Resin	H-15
Loctite Orange	I-23	Mattock	G-33	Multi-Zorb Granules	D-14
Loctite Threadlocker	I-54	Maxi Blade Fuses	A-32	Multicore Solder	I-53
Loncin Conversion Kits	D-18	Measuring Jugs	D-17	Multimeters	G-24
		Measuring Tools	G-27	Multipurpose Hose	B-21

Index

N			O-Clips, Assorted	H-24	Parallel Pin Punch Set	G-29
Nail Brush	I-23	O-Clips, Gas	F-1	Parcel Tape	I-15	
Nail Punch	G-29	O-Ring, Lever Lock	B-13	Particle Masks	J-14	
Neck Guard, Helmets	J-12	O-Rings	H-8	Parts Storage Boxes	I-9	
Needle Files	G-30	Oil Drain Pans	D-7	Parts Tray, Magnetic	G-38	
Neon Rear Lamp Unit	A-3	Oil Drip Trays	D-9	Pasting Brush	I-26	
Neoprene Gasket Sheet	I-26	Oil Pressure Gauge 12v	A-41	Patay Hose Adaptors	B-7	
Nibbler, Air	I-43	Oil Spill Kits	D-12	Patay Pump Diaphragm	B-5, B-7	
Nickel Brake Tubing	A-53	Oil Stone, Stihl	G-34	Patay Pump Spares	B-5, B-7	
Nightlatch, Yale	I-13	Oil Suction Hose	B-19	Patay Repair Kit	B-6	
Nilfisk Vac Accessories	I-42	Oil Suction Pump	D-7	Pavers Rubber Maul	G-33	
Nipple, Test Plugs	B-27	Oil Temp Gauge, 12v	A-41	PCL Air Tools	B-35	
Nipples, Malleable	B-14	Oil Treatment	I-56	PCL Blow Gun, Plastic	G-36	
Nitrile Gloves	J-8	Oil-Guard 2-Stroke Oil	D-5	PCL Fittings	B-33	
No Parking Sign	J-17	Oil, Engine & 2-Stroke	D-5	Peg Spanners	I-35	
No Smoking Sign	J-18	Olives, Assorted	H-29	Pencils	I-29	
Non Adhesive Zebra Tape	I-16	On/Off Control Box	E-13	Penetrating Lubricant	I-57	
Non Return Valve, 1" BSP	D-2	On/Off Switch 12/24v	A-36	Penny Washers	H-6	
Non Return Valve, Washer	A-48	On/Off Switch, Numatic	I-41	Percussion Drill, Corded	G-39	
Notepads	I-29	Open Ended Spanners	G-1	Percussions Drills	G-39	
Nozzle Cleaner, Welding	I-51	Orange Beacons	A-38	Personal Protective Equip- ment	J-1	
Nozzle Set, Quick Connect	B-30	Orange Gas Hose	F-1	Perspex Visor	J-11	
Nozzle, Pressure Washer	B-30, B-31	Orange Nitrile Gloves	J-8	Phillips Insert Bits	G-8	
Nozzles, Rivet Gun	H-10	Orbic Matting	J-18	Phillips Screwdrivers	G-9	
Nozzles, Welding	I-51	Orbital Sander, Air	B-35	Phillips Screwdrivers	G-9	
Numatic Dust Bags	I-39	Over Braided Air Line	B-32	Pick Axe	G-33	
Numatic Spares	I-39, I-41	Overalls	J-3	Pick-Up Tools, Magnetic	G-38	
Numatic Vac Accessories	I-42	Overbraided Hose	B-19	Piggy Back Terminals	A-30	
Number Plate Accessories	A-6	Overcentre Catches	A-20	Pigtail Assy, Propane	F-1	
Number Plate Fixings	H-11	Oxy Acetylene Hoses	I-50	Pigtail Fencing Spike	G-42	
Number Plate Fixings, Assorted	H-21	Oxygen Regulator	I-50	Piling Shackles	C-5	
Number Plate Lamp	A-2	P				
Number Punch Sets	I-29	P-Clips, Electrical	E-11, E-12	Pilot Drill, Diamond Core	G-20	
Number Stencils	I-28	Pad Bolts	I-2	Pilot Drill, Hole Saw	G-19	
Numbers, Number Plate	A-6	Padlock Spray	I-12	Pin, Towing Hitch	A-7	
Nut Caps	H-3	Padlocks	I-10	Pins, Split	H-9	
Nut Indicators, Wheel	A-24	Pads, Absorbent	D-14	Pipe Clips, Fuel	B-18	
Nut Lock	I-53	Paint Brushes	I-26	Pipe Couplings, Assorted	H-24	
Nut Splitters	G-28	Paint Brushes, Assorted	H-27	Pipe Flaring Tool	A-53	
Nuts, Assorted	H-17	Paint Markers	G-37, I-48	Pipe Joiners, Air Line	B-32	
Nuts, Steel	H-3	Paint Masks	J-14	Pipe Joiners, Hose	B-10	
Nutserts	H-10	Paint Rollers	I-27	Pipe, Fuel	B-18	
Nyloc Nuts	H-4	Paint Scraper	I-27	Piston Ring Compressors	G-29	
Nylon Backing Pads	I-37	Paint, Spray	I-30	Pitch Gauge, Screw	G-28	
Nylon Castor Wheels	I-5	Paint, Stencil	I-28	Plant Nappies	D-13	
Nylon Coated Wire Rope	C-11	Pallet Corner Protectors	C-13	Plant, Wiper Blades	A-47	
Nylon Plug 13 Amp	E-1	Pallet Trucks	I-8	Plasters	J-16	
Nylon Tubing	B-18	Pallet Wrap	I-19	Plasters, Assorted	H-25	
Nylon Wheels, Pallet Truck	I-8	Pallet, Spill	D-11	Plastic Bags	I-20	
		Pan Head Screws	H-11	Plastic Barrel Wrench	D-15	
		Panel Screws	H-13	Plastic Blow Gun	G-36	
		Panel Socket, 16/32 Amp	E-5	Plastic Brush	I-22	
		Panel Socket, Arc Welding	I-49	Plastic Chain	G-42	
		Paper Roll	I-25	Plastic Dust Sheet	I-27	
				Plastic Funnels	D-16	
				Plastic Jerricans	D-17	
				Plastic Mop Bucket	I-22	

Index

Plastic Number Plate Screws	H-11	Power Tools	G-39		
Plastic Parts Bins	I-9	Powered Saws	G-39	R	
Plastic Pipe Connectors	B-23	Pozi Insert Bits	G-7		
Plastic Pull Handle	I-1	Pozi Screwdrivers	G-9	R-Clips	A-10, I-4
Plastic Strapping	I-17	Pozi Screws	H-11	Ratchet Crimp Pliers	A-31
Plastic Tool Box	G-36	PPE	J-1	Radiator Accessories	A-55
Plastic Wallets	I-31	PPE, Chainsaw	J-9	Radiator Hose	B-20
Plastic Water Containers	I-26	PPE, Safety Boots	J-5, J-6	Radio Mini Fuses	A-32
Plastic/Rubber Wheels	I-6	Pre-Insulated Terminals	A-30	Rags, Cleaning	I-21
Plastice Drip Trays	D-10	Precision Screwdrivers	G-24	Rags, White Cotton	A-50
Plate Washers	H-7	Pressure Washer Nozzles	B-31	Rainsuits	J-1
Platform Trolley	I-7	Pressure Washer Spares	B-28	Rake, Garden	G-34
Plier Set, 3 Piece	G-26	Prevost Fittings	B-34	Rake, Tarmac	F-9
Pliers	G-23	Primer, Spray	I-30	Rapid Staple Guns	I-19
Pliers, O-Clip	B-32	Prop Pins	I-4	Ratchet Handles, Socket	G-4
Plug Cover, Trailer	A-5	Prop Stands	A-13	Ratchet Lever Hoists	C-8
Plug In Timer	E-1	Propane Gas	F-7	Ratchet Load Binders	C-12
Plug Tester, 13-Pin	A-5	Propane Gas Hose	F-1	Ratchet Straps	C-13
Plug Tester, 7-Pin	A-5	Propane Heaters	F-5	Ratchet Taps	G-18
Plug, 16/32Amp	E-5	Propane Regulator	I-50	Rawhide Hammers	G-32
Plug, Barrel	D-15	Propane Regulators	F-2	Rawl Plugs	H-11
Plug, Trailer	A-5	Propane Spanner	F-8	Rawlbolts	H-14
Plug/Bolt Spanners	G-2	Pruning Saw	G-34	RCD Breaker, Inline	E-3
Plugging Chisel	G-31	Pruning Shears	G-34	RCD Circuit Breaker	E-1
Plugs, 13 Amp	E-1	Pry Bars	G-31	Rear Fog Lamp	A-2
Plugs, Malleable	B-14	PTFE Spray	I-57	Rear Reversing Cameras	A-46
Plumbers Gas Torch	F-3	PTFE Tape	B-15, I-14	Rear Trailer Light	A-2
Plunger, Drain	B-26	Pull Handle, Plastic	I-1	Rechargeable Battery	E-9
Plunger, Sink	I-25	Puller, Wire Tie	I-21	Rechargeable Torch	E-8
Pneumatic Wheels	I-7	Pullers, 3-Leg	G-29	Reciprocating Saw, Corded	G-39
Pocket Knife	G-22	Pullers, Cable	C-8, C-9	Reciprocating Saw, Cordless	G-40
Polishing Cloth	I-21	Pump Couplings	B-10	Reciprocating Saws	G-39
Polishing Discs	I-35	Pump, Diesel	D-2	Recoiled Air Line	B-32
Polyester Lifting Straps	C-1	Pump, Tyre	A-24	Record Bolt Croppers	G-25
Polyester Resin	H-15	Punch Sets	I-29	Record Stillson Wrenches	G-2
Polypropylene Bags	I-20	Punch, Nail	G-29	Rectangular Reflector	A-3
Polypropylene Rope	A-18	Puncture Sealant	A-25	Red Parts Bins	I-9
Polypropylene Strapping	I-17	Puncture Repair Kit	A-24	Red Warning Lamp	A-35
Polypropylene String	I-20	Push Button Breaker	E-10	Red/White Chain	G-42
Polythene Bags	I-20	Push Trolleys, Beam	C-8	Reduces, High Pressure	B-29
Polythene Gloves	J-8	PVC Covered Mains Cable	E-3	Refill, Spill Kit	D-13
Polythene Sacks	I-20	PVC Electrical Tape	I-15	Reflective Vehicle Tape	A-43
Pom Pom Grease Gun	D-3	PVC Hose	B-21	Reflectors, Vehicle	A-3
Ponstar Pump Spares	B-8	PVC Insulation Tape	E-11	Refuse Sacks	I-20
POP Rivets	H-10	PVC Trim Cutters	G-25	Regulators, Gas	F-2
Post Hole Digger	G-33	PVC Tubing	B-18	Regulators, Gas Welding	I-50
Post Rammer	G-33, G-42	PVC Tubing, Washer	A-48	Reinforced Braided Hose	B-21
Potato Sack Ties	I-21	PVC Work Gloves	J-7, J-8	Relays, 12/24v	A-36
Potato Sacks	I-20			Remote Control Batteries	E-10
Pouring Jugs	D-17	Q		Renus Type Couplings	B-16
Powder Fire Extinguisher	J-14	Q-Bond Adhesive	I-54	Repair Kit, Bodywork	A-55
Powdered Gloves	J-8	Quick Links, Untested	C-10	Repair Kit, Patay	B-6
Power Cable, Pump	B-8	Quick Release Clamps	G-26	Repair Washers	H-6
Power Inverter, 12v - 230v	A-41	Quick Release Couplings	B-29	Replacement Glass, Mirror	A-45
Power Steering Fluid	I-56	Quick Release Terminals	A-27	Resin, Chemical Anchor	H-15

Index

Resin, Stud Anchor	H-15	Rubber Gloves	J-4	Screw Pitch Gauge	G-28
Resuciate	J-15	Rubber H07 Cable	E-3	Screwdrivers	G-9
Retainer, FIXT	I-53	Rubber Mallets	G-33	Screws, Number Plate	A-6
Retaining Clips	H-8	Rubber Matting	J-18	Screws, Self Tapping	H-11
Reversing Alarm	A-36	Rubber Mount, Generator	E-10	Scrubs	I-23
Reversing Camera Kits	A-46	Rubber Nuts	H-15	SD45 Pump Spares	B-7
Rhodorseal Silicone Gasket	I-55	Rubber O-Rings	H-8	SD60 Pump Spares	B-7
Rigid Water Hose	B-9	Rubber Pipe, Grease Gun	D-3	SDS Chucks & Adaptors	G-15
Rim Lock, Yale	I-13	Rubber Plug, 13 Amp	E-1	SDS Hammer Drill, Corded	G-39
Rims, Trailer Wheel	A-16	Rubber Plunger	I-25	SDS Hammer Drill, Cordless	G-40
Ring Compressors, Piston	G-29	Rubber Plunger, Drain	B-26	SDS Max Drills	G-14
Ring Spanners	G-1	Rubber Seal, Geka	B-16	SDS Plus - Max Adaptor	G-14
Ring Terminals	A-31	Rubber Washers	B-10	SDS Plus Bit Holder	G-8
Rivet Guns	H-10	Rubber Wheels	I-6	SDS Plus Drills	G-13
Riveter, Air	I-43	Rubble Sacks	I-20	SDS Plus Hammer Drills	G-39
Rivets	H-10	Rules, Steel	G-27	Seal, 7-Pin Socket	A-5
Road Sign Clips	I-16			Sealant Gun	I-55
RoadStart Power Packs	A-27	S		Sealant, Silicone	I-55
Rock Salt	A-54	Sabre Blades	G-20	Sealer, Poly Strapping	I-17
Rocker Switch	A-36	Sack Ties	I-21	Sealer, Steel Strapping	I-18
Rocker Switch, 12v	A-4	Sack Trucks	I-7	Seals, Poly Strapping	I-17
Rockfall Boots	J-5, J-6	Safety Boots	J-5, J-6	Seals, Steel Strapping	I-18
Roll Pins	H-9	Safety cable, Trailer	A-7	Seat Covers	A-54
Roll Pins, Assorted	H-21	Safety Fittings, Air Line	B-34	Secateurs	G-34
Roll, Absorbent	D-14	Safety Glasses	J-10	Secondary Coupling	A-7
Roller, Painting	I-27	Safety Glasses, Husqvarna	J-9	Security Chain	I-13
Rollers, Pallet Truck	I-8	Safety Grip Tape	I-15	Security Nuts	H-15
Roofing Blowtorch kits	F-4	Safety Helmet, Site	J-10	Security Posts	A-22
Roofing Bolts	H-2	Safety Matting	J-18	SEH50X Pump Spares	B-3
Roofing Screws	H-13	Safety Signs	J-17	Self Adhesive Letters	A-6
Rope Grips, Wire	C-10	Safety Tags, Scaffold	G-41	Self Adhesive Tape	I-14
Rope Hoist, Wire	C-9	Safety Wear, Husqvarna	J-9	Self Amalgamating Tape	I-14
Rope Hooks	A-20	Sandbags	I-20	Self Drilling Screws	H-13
Rope Thimbles	C-10	Sander, Air	I-43	Self Locking Hooks	C-4
Rope, Polypropylene	A-18	Sanding Belts	I-38	Self Tapping Screws	H-11
Rope, Wire	C-2	Sanding Block	I-27, I-38	Self Tapping Screws, As- sorted	H-20
Rotary Hand Pumps	B-8	Sanding Discs	I-37	Sellotape	I-14
Rotary Nozzle, Press. Washer	B-31	Sanding Sponge	I-38	Semi Rigid Nylon Tubing	B-18
Rotary Switch	A-36	Sandpaper Sheets	I-38	Semi Rotary Hand Pumps	B-8
Rotating Beacons	A-38	Santa Sacks	I-20	Service Kit, Knott Coupling	A-15
Rotavator Clips	I-4	Sash Clamps	G-26	Set Screws, Assorted	H-16
Round Bar, Assorted	H-26	Saw Gloves	J-9	Setscrews & Bolts	H-1
Round Files	G-30	Saw, Hand	G-21	Shackles, Lifting	C-5
Round Mouth Shovel	G-33	Scaff Tags	G-41	Shampoo, Vehicle Wash	A-50
Round Reflector	A-3	Scaffolding Accessories	G-41	Sharpening Stone, Stihl	G-34
Round Slings, Lifting	C-1	Scaffolding Beacons	G-41	Shear Nuts	H-15
Round Work Lamp	A-4	Scissors	I-19	Shear Pins, Hoist	C-9
Rubawrap Tape	I-14	Scissors, Wallpapering	I-27	Shears, Steel Strapping	I-18
Rubber Air Line	B-32	Scotchlok Connectors	A-31	Shield Anchors	H-14
Rubber Apron	J-7	Scourer	I-24	Shoes, Safety	J-5, J-6
Rubber Boots	J-7	SCR50 Pump Spares	B-3	Shovel, Coal	I-22
Rubber Buffer, 250mm	I-1	Scraper, Decorating	I-27	Shovels	G-33
Rubber Castor Wheels	I-5	Scraper, Windscreen	A-49	Shutter Padlocks	I-11
Rubber Fuel Pipe	B-18	Screen Wash	A-49	Side Cutters	G-23
Rubber Gasket Sheet	I-26	Screw Extractor Set	G-28	Side Marker Lamp	A-2

Index

Sidelight Bulb	A-34	Socks	J-7	Stainless Steel Hinges	I-1
Sievert Gas Burner	F-9	Soft Broom	I-22	Stainless Steel Nuts	H-4
Signfix Banding Tools	I-16	Soft Faced Hammers	G-32	Stainless Steel Rules	G-27
Signograph Engraver	G-37	Soldering Accessories	I-53	Stainless Steel Washers	H-6
Signs, Diamond Warning	A-44	Soldering Irons	G-24	Stales, Hammer	G-32
Signs, Safety & Warning	J-17	Soldering Kits	G-24	Standpipe, Water	B-24
Silicon Carbide Grinder Wheel	I-35	Solderless Nipples, Assorted	H-28	Stanley Knife	G-22
Silicone Grease	I-57	Solid Wheels	I-7	Stanley Tape Measures	G-27
Silicone Sealant	I-55	Son of a Gun Spray	I-56	Staple Guns	I-19
Silver Steel	I-3	Spacer, Towing Hitch	A-7	Staples, Rapid	I-19
Simplite Pump Diaphragm	B-8	Spade, Garden	G-34	Starrett Holesaws	G-19
Single Core Cable	E-4	Spanner, Peg	I-35	Starter Cable	A-29, E-4
Single Core Cable, Auto	A-29	Spanners	G-1	Starter Leads	A-27
Single Leg Chain Slings	C-3	Spanners, Gas	F-8	Starter, Battery	A-26
Sink Plunger	I-25	Spanners, Scaffold	G-41	Starters, Fluorescent	E-9
SIP Welders	I-45	Spare Lens, Beacon	A-38	Steel Banding	I-18
Site Fencing Couplers	G-41	Spark Plug Sockets	G-3	Steel Barrel Wrench	D-15
Site Helmets	J-10	Spazzle, Tar Spreading	F-9	Steel Drip Trays	D-9
Site Lighting	E-7	Speaker Cable	A-29, E-4	Steel Epoxy Stick	I-54
Site Safety Sign	J-17	Speed Fasteners	H-19	Steel Hinges	I-1
Site Transformers, 110v	E-6	Speedfit Couplings	B-23	Steel Jerricans	D-17
Skin Safety Deposits	I-24	Spider Ball, 110v	E-6	Steel Jobber Drills	G-10
Skip Nets	C-12	Spigots, Beacon Mounting	A-39	Steel Rules	G-27
Sledge Hammers	G-32	Spil Kits	D-12	Steel Tool Box	G-36
Sleeve Anchors	H-14	Spill Mats	D-10	Steel Wool	I-42
Sleeve Terminals	A-31	Spilltrapper	D-9	Stencil Spray	I-28
Slider Pin, Towing Coupling	A-9	Spiral Wrap	E-13	Stencils	I-28, I-29
Slider, Towing Coupling	A-9	Spirit Levels	G-28	Step Drills	G-12
Sliding Tee Bars	G-4	Splicing Kit, O-Ring	H-8	Step, Van	A-21
Slings, Lifting	C-1	Split Conduit, PVC	E-13	Stepped Adaptors, Patay	B-7
Slotted Insert Bits	G-8	Split Pins	H-9	Steps	I-9
Slotted Screwdrivers	G-9	Split Pins, Assorted	H-21	Sterile Dressings	J-16
Slump Cone	G-38	Splitter Box, 110v	E-6	Stick-on License Holder	A-43
Smoke Treatment	I-56	Sponge Scourer	I-24	Stihl 2-Stroke Oil	D-5
Snap-Off Blade Knife	G-22	Sponge, Vehicle Wash	A-50	Stihl Clothing	J-2
Snatch Block, Swing	C-9	Spot Lamp, Vehicle	A-4	Stihl Face Shield	J-10
Snatch Blocks	C-7	Spray Adhesive	I-54	Stihl Gloves	J-8
Snips, Aviation	G-30	Spray Bottles	I-59	Stihl Saw Blades	I-33
Snips, Tin	G-26	Spray Gun Paint	I-44	Stihl Torx Driver	G-7
Snow Scraper	A-49	Spray Paint	I-30	Stillson Wrenches	G-2
Snow Shovels	A-54	Sprayer, Backpack	G-34	Stitching Screws	H-13
Soap, Hand	I-23	Spring Bolts	A-21, I-2	Stone Cutting Discs	I-33
Socket, Absorbent	D-13	Spring Hook & Chain	A-20, I-4	Stone Grinding Set	I-36
Socket Accessories	G-4	Spring Hooks, Untested	C-11	Stop Button, Emergency	E-13
Socket Cover, Trailer	A-5	Spring Pins	H-9	Stop Cock key	B-24
Socket Grub Screws	H-3	Spring Washers	H-6	Stop Leak, Radiator	A-55
Socket Head Screws	H-2	Springs, Assorted	H-22, H-26	Stop Rings	A-11
Socket Sets	G-2	Square Insert Bit	G-8	Stop Tap	B-24
Socket Tester, 13-Pin	A-5	Square Plate Washers	H-7	Stop/Go Pole	J-18
Socket Tester, 7-Pin	A-5	Square Rotovator Clips	I-4	Stop/Tail Lamp	A-2
Socket, Trailing 16/32Amp	E-5	Square Work Lamp	A-4	Stop/Tail/Indicator Bulb	A-34
Sockets, 13 Amp	E-1	Squares, Engineers	G-27	Storage Box, Trailer	A-18
Sockets, Chrome Vanadium	G-3	Stabila Spirit Levels	G-28	Storage Boxes/Bins	I-9
Sockets, Impact	G-5	Stainless Steel Banding	I-16	STP Cockpit Spray	A-50
Sockets, Malleable	B-14	Stainless Steel Electrodes	I-49	STP Valeting Spray	I-56
				Straining Screws	C-10

Index

Strapping, Polypropylene	I-17	Tap, Barrel	D-15	Tile Blade, Husqvarna	I-32
Strapping, Steel	I-18	Tape Dispenser	I-15	Tin Can Strainer	B-9
Stretch Film	I-18	Tape Measures	G-27	Tinmans Solder	I-53
String, Polypropylene	I-20	Tape, Adhesive	I-14	Tinsnips	G-26
Strops, Lifting	C-1	Tape, Insulation	E-11	Titalium Padlocks	I-10
Strum Box, Patay	B-5	Tape, Measuring	G-27	Toggle Clamps	A-20, I-3
Stubby Spanners	G-1	Taper Drift, Diamond Core	G-20	Toggle Switch	A-36
Stud Lock	I-53	Taper Mouth Shovel	G-33	Toilet Pump, Patay	B-5
Studding Connectors	H-15	Taps, Hand	G-16	Toilet Roll	I-25
Studs, Knott Wheel	A-14	Tar Boiler Kits	F-8	Ton Bag	I-20
Submersible Pump Kits	D-2	Tar Buckets	F-9	Tool Boxes	G-36
Submersible Pump Spares	B-8	Tarmac Hot Shoe	F-9	Tool Lanyard	J-4
Suction Filter, Pressure Washer	B-30	Tarmac Jute Sheets	F-9	Tool Organiser	G-35
Suction Hose	B-9, B-21	Tarmac Tools	F-9	Toolbox Lock	A-21
Suction Pump, Oil	D-7	Tarpaulin	A-18	Tools	G-1
Sugar	I-24	Tarpaulins	C-12	Torch Bulb, Krypton	E-9
Suitcase Generator	D-18	Task Light, Site	E-7	Torch, Bullfinch	F-3
Sump Plug Washers, Assorted	H-19	Task Lighting, Vehicle	A-4	Torch, Gas Cutting	I-50
Sump Pump	D-7	TCT Tile & Glass Bits	G-15	Torches	E-8
Sun Peak Visors	J-12	Tea Bags	I-24	Torches, MIG Welding	I-52
Superglue	I-53	Tea Towels	I-24	Torque Wrench	A-25
Support, Trailer, Wind Up	A-13, A-18	Tee Bar Allen Keys	G-6	Torx Driver, Stihl	G-7
Suspension Units, Trailer	A-16	Tee Handle, Garage	I-3	Torx Head Screws	H-12
Swarfega	I-23	Tee Handled Wrenches	G-6	Torx Insert Bits	G-7
Sweeper Castor Wheels	I-6	Tee Manifold, Propane	F-1	Tote Bags	G-35
Sweeping Brush	I-22	Tek Screw Driver	G-9	Touch Up Brushes	I-26
Swing Type Snatch Block	C-9	Tek Screws	H-13	Tow Ball	A-7
Switch, Changeover	E-10	Telescopic Bonnet Stay	A-21	Tow Pin	A-9
Switch, Hoist Control	E-13	Telescopic Parking Jacks	A-13	Tow Pole	A-19
Switches, Dashboard	A-36	Tensioner, Poly Strapping	I-17	Tow Rope	A-19
Swivel Adaptors, High Pressure	B-29	Tensioner, Steel Strapping	I-18	Towel, Paper	I-25
Swivel Castors	I-6	Terex Rear Lamp Unit	A-3	Tower Bolts	I-2
Swivel Glands, Cable	E-13	Terminal Blocks	E-12	Towing Bracket, Bradley	A-8
Swivel Hooks, Lifting	C-4, C-7	Terminal Protector	A-28	Towing Coupling	A-9
Swivel Hooks, Untested	C-11	Terminals, Assorted	H-23	Towing Couplings	A-11
Swivel Nut/Tail, Brass	B-11	Terminals, Battery	A-27	Towing Eye, Weld On	A-10
SWL Tags	C-11	Terminals, Crimp	A-30	Traffic Cones	G-42
Sword Pin	A-20	Test Moulds, Concrete	G-38	Trailer Boards	A-1
Syphon Kit, Fuel	D-2	Test Plugs, Drain	B-27	Trailer Brake Shoe Kits	A-17
Syphon Pumps	B-8, D-15	Tester, Blade Fuse	A-33	Trailer Cable	A-6, E-4
		Tex Pen Paint Markers	I-48	Trailer Covers	A-18
		Thermal Gloves	J-7	Trailer Hardware	A-20
		Thermal Socks	J-7	Trailer Hitch Lock	A-7
		Thermoplastic Tool Boxes	G-36	Trailer Jacks	A-13
		Thimbles, Wire Rope	C-10	Trailer Lighting	A-2
		Thread Forming Tools	G-16	Trailer Mud Wings	A-16
		Thread Gauge, Tyre	B-36	Trailer Pins	I-4
		Thread Repair Helicoils	G-18	Trailer Plugs & Sockets	A-5
		Threaded Nutserts	H-10	Trailer Suspension Units	A-16
		Three Core Electrical Cable	E-3	Trailer Wheels	A-16
		Three Square Files	G-30	Trailer, Breakaway Cable	A-9
		Through Bolts	H-13	Trailer, Handbrake	A-12
		Tie Down, Bungee	A-18	Trailer, Plug Holder	A-10
		Ties, Cable	E-11	Trailer, Safety Chain	A-10
		TIG Welders	I-45	Trailer, Security Ball	A-10
		Tile & Glass Bits	G-15	Trailing Socket, 16/32Amp	E-5
T					
T-Bar Clamps	B-10				
T-Handle, Canopy	A-21				
T-Piece, Washer	A-48				
Tachograph Equipment	A-51				
Tacti-Cut Blades	I-32				
Tags, Metal Tie-On	I-31				
Tank Gauges	D-16				
Tap & Die Sets	G-17				
Tap Connectors	A-31				
Tap Wrenches	G-18				

Index

Trailing Sockets, 13 Amp	E-1	UV Protective Glasses	J-9	Water Pump Pliers	B-13
Transformers, 110v	E-6			Water Pump Spares	B-1
Transport Rings, Weld-On	C-5	V		Water Pumps, Petrol	B-4
Tray, Paint Roller	I-27			Water Temp Gauge, 12v	A-41
Trestle Pins	I-4	Vacuum Pump	D-7	Water Valves	B-15
Triangle Files	G-30	Valeting Spray	I-56	Watering Can	G-35
Triangle Load Marker	A-43	Valve Grinding Stick	G-37	Waterproof Gloves	J-7
Triangle Reflector	A-3	Valves, Tyre	A-24	Waterpump Pliers	G-23
Trigger Nozzle, Fuel	D-1	Van Door Lock	I-12	Wax Crayon	A-25
Trim Clips, Assorted	H-22	Van Seat Cover	A-54	WB20XT Pump Spares	B-1
Trim Shears, PVC	G-25	Van Step, Double	A-21	WB30XT Pump Spares	B-1
Trimming Knife	G-22	Van, Wiper Blades	A-47	WD40	I-57
Triple Connector, Geka	B-16	Vari-Cut Blades	I-32	Wear Sleeve, Load Straps	C-13
Triple Flint Lighter	I-51	Variable Gas Regulators	F-2	Webbing Guards	C-13
Trolley Jacks	A-23	VDE Pliers	G-23	Webbing Straps, Ratchet	C-13
Trolley Wheels	I-5, I-6	Vehicle Height Indicator	A-43	Webbing Strops	C-1
Trolley, Platform	I-7	Vehicle Lighting	A-3	Wedge Bulb	A-34
Trolley, Welder	I-45	Vehicle Mirrors	A-45	Weld-on DIN Spigot	A-39
Trolleys, Gas Cylinder	I-52	Vehicle Wash Equipment	A-50	Weld-On Lifting Hooks	C-5
Trousers, Chainsaw	J-2	Velcro	I-15	Welders	I-45
Trousers, High-Vis	J-1	Velox Type Couplings	B-16	Welders Gloves	J-7
Trug	G-35	Vernier, Digital	G-27	Welding Accessories	I-47
Tube Joiners	B-10	Vertex Couplings	B-33	Welding Clamp	G-26
Tubing & Hose	B-18	Vest, High-Vis	J-1	Welding Clamps	I-46
Tungsten Tile & Glass Bits	G-15	Vices, Bench	G-26	Welding Curtain	I-48
Turbo Diamond Blades	I-33	Vinylon Fuel Pipe	B-18	Wellington Boots	J-7
Twin Adaptor, Cigarette Lighter	A-41	Visor Holder	J-11	Wet & Dry Paper	I-38
Twin Core Cable	E-4	Visor, Face	J-10	Wheel Bearing, Trailer	A-17
Twin Core Cable, Auto	A-29	Visors, Husqvarna	J-11	Wheel Bearings, Knott	A-14
Twin Manifold, Propane	F-1	Voltage Tester	G-24	Wheel Chocks	A-23
Twinthread Screws	H-12	W		Wheel Clamps	A-22
Two Core Electrical Cable	E-3			Wheel Dressers	I-36
Two Stroke Oil	D-5	Wacker Pump Diaphragm	B-8	Wheel Gate Valve	B-15
Tyre Accessories	A-24	Wall Brush	I-26	Wheel Hub, Trailer	A-16
Tyre Cement	A-25	Wall Plugs	H-11	Wheel Nut Indicators	A-24
Tyre Inflator	B-36	Wallets, Document	I-31	Wheel Nuts, Knott	A-14
Tyre Lever	A-25	Wallpapering Scissors	I-27	Wheel Straps	C-13
Tyre Pressure Gauge	B-36	Warning Buzzer, 12v	A-36	Wheel Studs, Knott	A-14
Tyre Pump	A-24	Warning Diamonds	A-44	Wheel Wrench	A-25
Tyre Sealant	A-25	Warning Signs	J-17	Wheelbarrow	G-35
Tyre Valves, Assorted	H-22	Warning Triangle	A-54	Wheelbarrow Chain Sling	C-2
Tyres, Trailer Wheel	A-16	Warrior Gloves	J-7	Wheelbarrow Wheels	I-7
Tyvek Boilersuits	J-3	Washdown Guns	B-17, B-28	Wheels, Pallet Truck	I-8
		Washer Jets	A-49	Wheels, Rubber Tyred	I-6
U		Washer Pump, Windscreen	A-48	Wheels, Trailer	A-16
U Nuts		Washer Tubing, PVC	A-48	Whetstone, Stihl	G-34
UK Marker Boards	A-42	Washer, Pump Coupling	B-10	Whistle Washer, Tar Boiler	F-8
UNC Hand Taps	G-16	Washers, Assorted	H-18	White Grease	I-57
UNC Set Screws		Washers, Flat	H-5	White Number Plate	A-6
UNF Hand Taps	H-2	Washroom Supplies	I-24	White PVC Flex	E-3
UNF Setscrews	G-16	Waste Oil Container	D-7	Whiteboards	I-29
Unstripper Tool	H-1	Water Containers	I-26	Whitener	I-24
Universal Joints, Socket	A-31	Water Couplings, Geka	B-16	Wickham Pump Diaphragm	B-8
Untested Fittings	C-10	Water Nozzles, Brass	B-16	Wide Band Hose Clips	B-22
		Water Pump Hose	B-9	Wide Broom Head	I-22
				Winch Strap, Drum Winch	A-19

Index

Winch, Fulton	A-19	Yellow Electrical Cable	E-3
Wind Up Corner Brace	A-18	Yellow Fuel Pipe	B-18
Window Scraper	I-27	Yellow Number Plate	A-6
Windscreen Accessories	A-48	Yellow Safety Helmet	J-10
Windscreen Hammer	G-37	Yellow Wax Crayon	A-25
Wing Nuts	H-5	Yellow Work Gloves	J-7
Wiper Blade Refills	A-47		
Wiper Blades	A-47, A-48	Z	
Wipes, Medical	J-16		
Wire Brushes	G-29	Zebra Tape	I-15
Wire Brushes, Hand	I-42	Zinc Primer	I-30
Wire Brushes, Rotary	I-36	Zip Ties	E-11
Wire Cutters	G-23	Zirconium Flap Discs	I-34
Wire Hangers	H-14		
Wire Rope	C-2		
Wire Rope & Hook, Winch	A-19		
Wire Rope Cutters	C-11, G-25		
Wire Rope Grips	C-10		
Wire Rope Hoist	C-9		
Wire Rope Spray	I-58		
Wire Rope, Nylon Coated	C-11		
Wire Ties	I-21		
Wire Ties, Label	I-31		
Wire, Locking	C-11		
Wire, MIG Welding	I-52		
Wiring Grommets	E-12		
Wood Screws	H-12		
Wooden Hand Brush	I-22		
Woodruff Keys, Assorted	H-21		
Work Clothing	J-1		
Work Gloves	J-7, J-9		
Work Helmets	J-10		
Work Lamps	A-4		
Work Lights, Site	E-7		
Workwear	J-1		
Worm Screw, Drain	B-26		
Woven Polypropylene Bags	I-20		
WP20X Pump Spares	B-3		
Wrecking Bars	G-31		
Wrench, Barrel	D-15		
Wrench, Torque 1/2" Drive	A-25		
Wrenches, Adjustable	G-1		
Wrenches, Stillson	G-2		
WX10 Pump Spares	B-2		

X

Xenon Bulb	A-34
------------	------

Y

Y Manifold, Propane	F-1
Yale Locks	I-13
Yard Brush	I-22
Yellow Duster	I-21



L&S Online

- Latest Offers and Promotions
- Fast Delivery
- No Hassle Returns
- Excellent Reviews

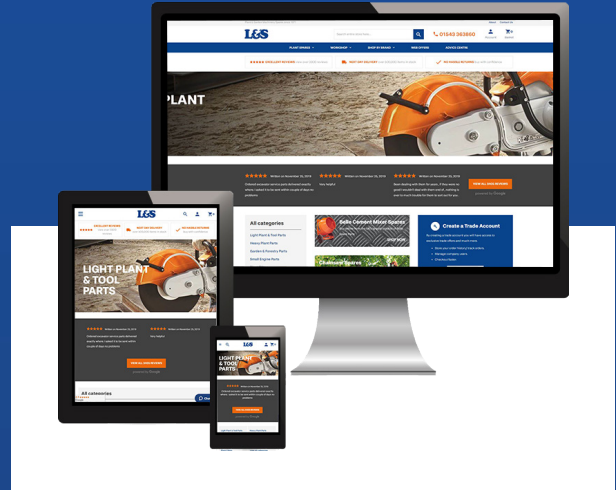

www.lsengineers.co.uk

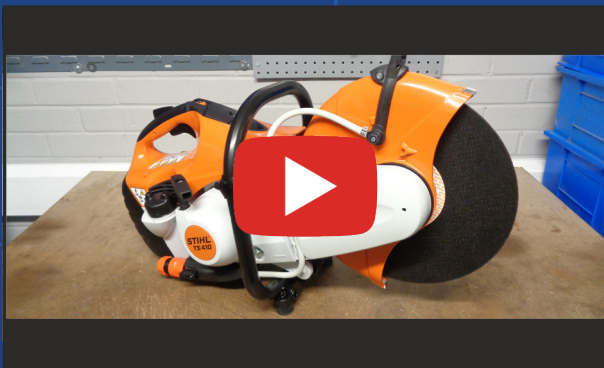

L&S How to
Subscribe to our **YouTube**
Channel for New and Exclusive
Content Including How to
Videos!



L&S Social Media

Visit us on Facebook:

www.facebook.com/lsengineers/

Follow us on Twitter:

[@LS_Engineers](https://twitter.com/LS_Engineers)

Follow us on Instagram:

[@lsengineers](https://www.instagram.com/lsengineers)

See us on YouTube:

www.youtube.com/lsengineerstv



Opening Hours

Sales Office:
Monday - Friday 8.00am - 5.00pm

Click & Collect:
Monday - Friday 8.00am - 5.00pm

How to find us

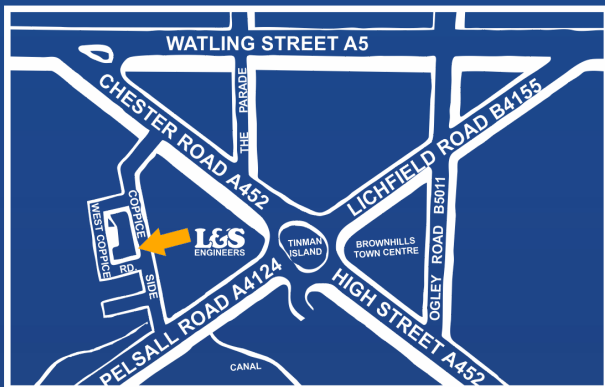

Coppice Side, West Coppice Road
Brownhills, Walsall
WS8 7EX

Tel. 01543 378189

sales@lsengineers.co.uk
www.lsengineers.co.uk

Carriage

2-3 DAY	UP TO 5KG	£2.25 - £3.50
NEXT DAY	UP TO 25KG	£5.30 - £6.75 (Bulky)
NEXT DAY BEFORE 10	UP TO 25KG	£16.00
NEXT DAY BEFORE 12	UP TO 25KG	£11.00
SATURDAY DELIVERY	UP TO 25KG	£20.00
OVERWEIGHT/ OVERSIZED		FROM £17.75
PALLET	POSTCODE DEPENDANT	FROM £50.00
NORTHERN ISLAND, SCOTTISH HIGHLANDS, ISLE OF MAN, ISLE OF WIGHT & ISLES OF SCILLY		
2-3 DAY	UP TO 5KG	£2.25 - £3.50
COURIER SERVICE	WEIGHT DEPENDANT	FROM £7.50
OVERWEIGHT/ OVERSIZED		FROM £21.50

VAT

All prices in this catalogue are subject to VAT

We reserve the right to increase prices without prior notice.

Replacement spares in this catalogue are not genuine parts except where specified.
Manufacturers names, part numbers and descriptions are used for reference only.

L&S Engineers will endeavour to meet delivery date quoted but delivery dates are given and intended as an estimate only and if there are any circumstances whatsoever which prevent delay or delivery, L&S Engineers shall not be liable for any consequential loss or damage.



L&S ENGINEERS

L&S Engineers Ltd, Coppice Side, West Coppice Road
Brownhills, Walsall, WS8 7EX

www.lsenengineers.co.uk
Telephone: 01543 378189
sales@lsenengineers.co.uk

